

INSTRUCTION

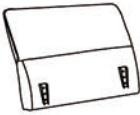

A*8



B*1

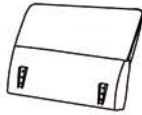

C*1

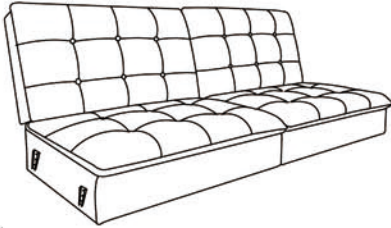

D*1

STEP 1

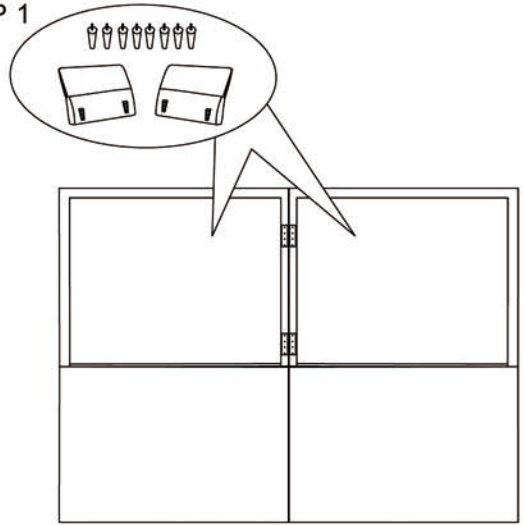

STEP 2

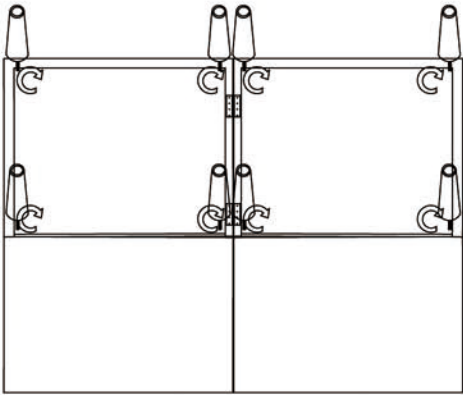

STEP 3

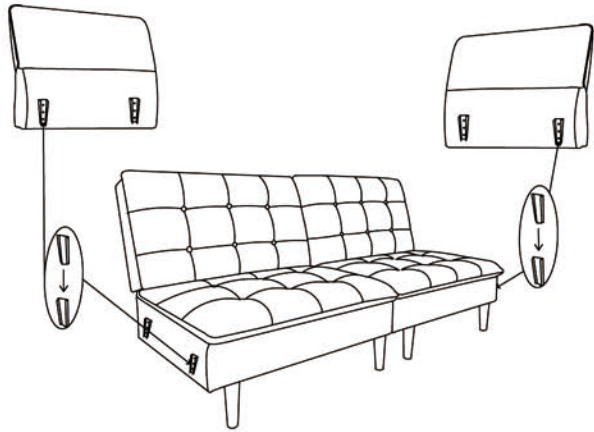

STEP 4

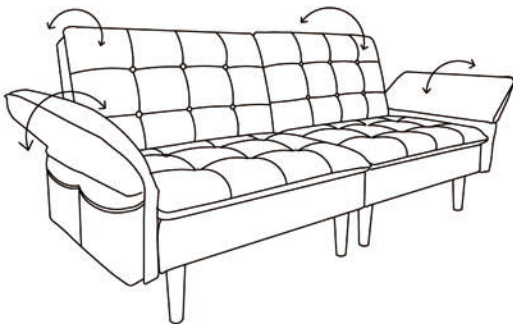

STEP 5

