

# ASSEMBLY INSTRUCTIONS

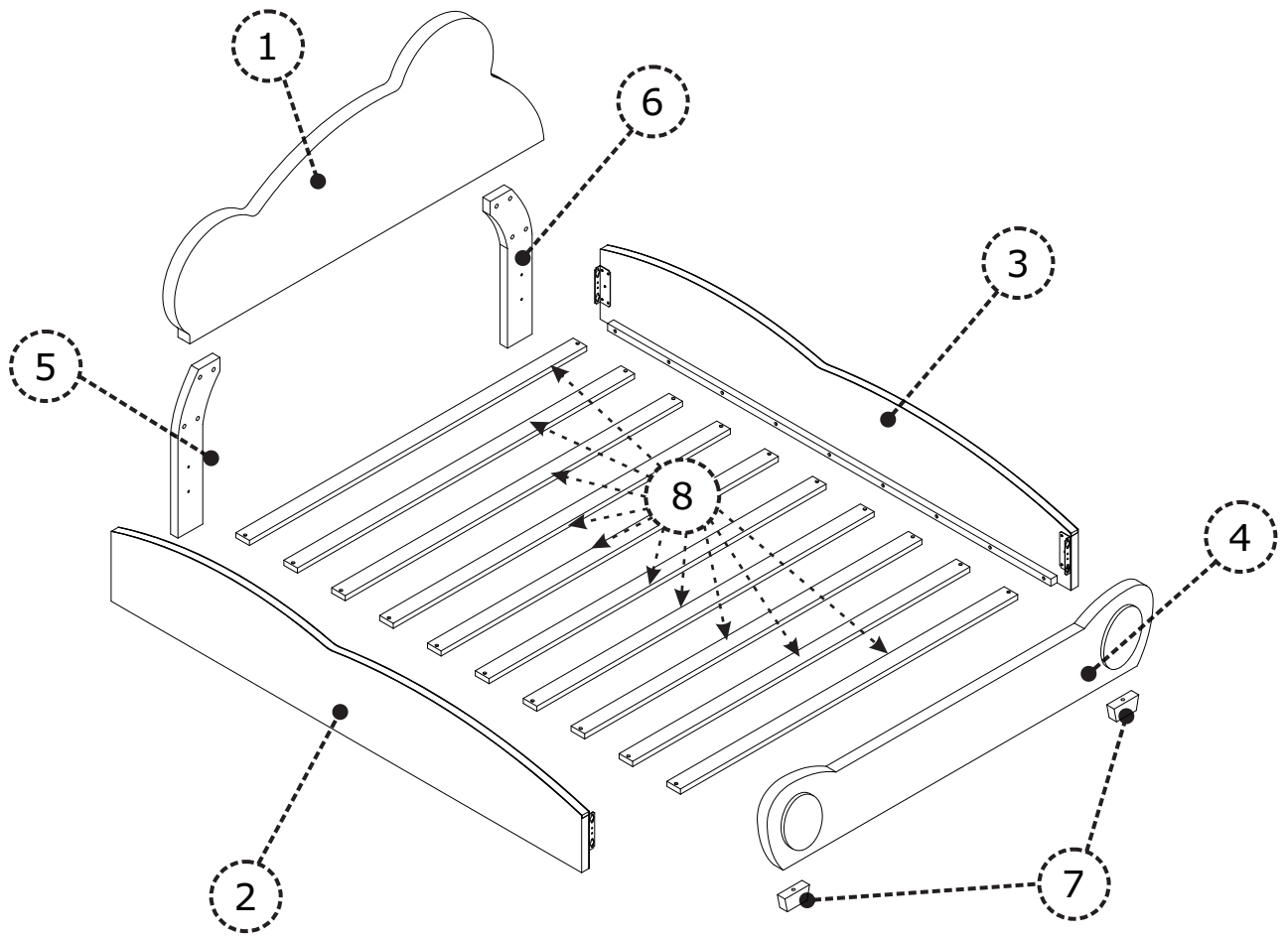

# PARTS

Check that you've received  
all parts listed below.

**BOX: 1/2**

1 x 1



Head Board

5 x 1

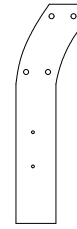

Leg Board Left

6 x 1

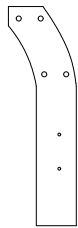

Leg Board Right

7 x 2



Legs

8 x 10

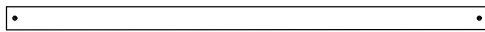

Slats

Hardware



# PARTS

Check that you've received  
all parts listed below.

**BOX: 2/2**

2 x 1

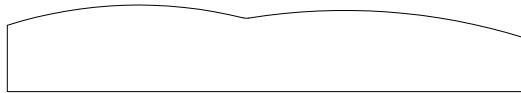

Side Board Left

3 x 1

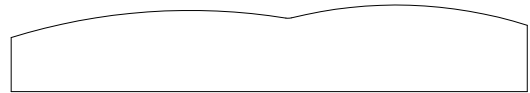

Side Board Left



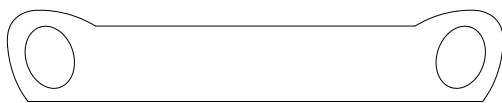

4 x 1



Foot Board





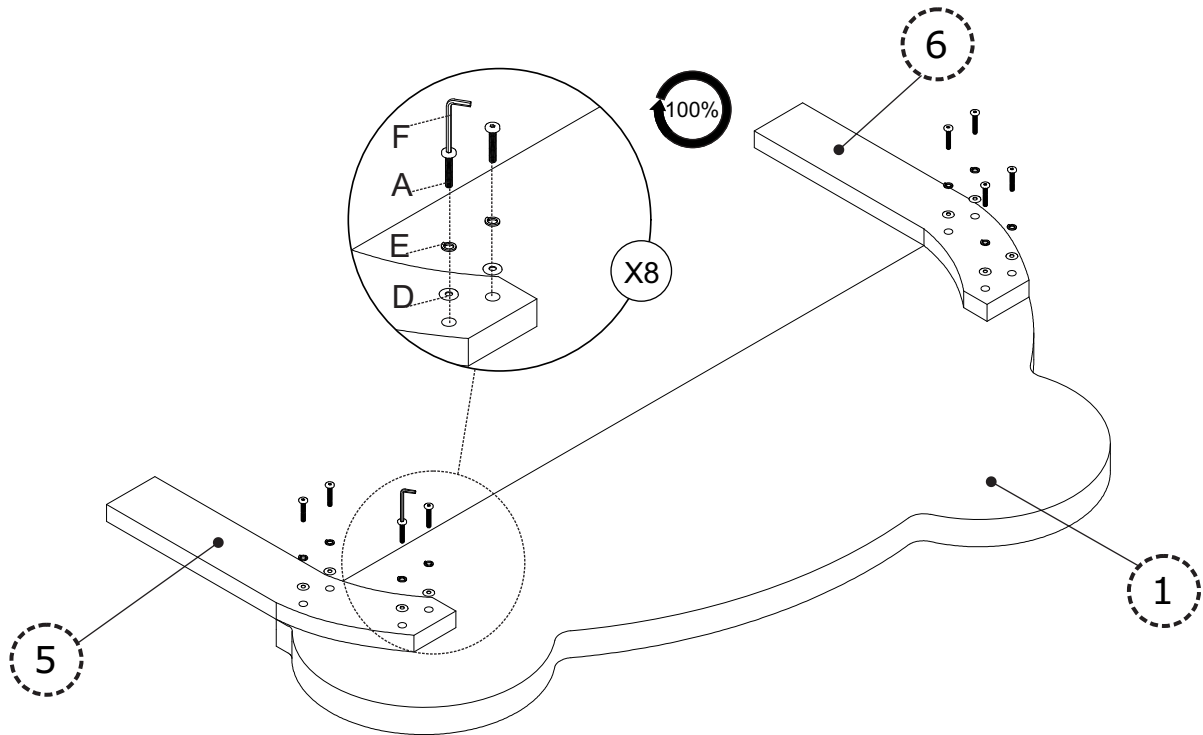

# STEP 1

A x 8 	D x 8 	E x 8 	F x 1 	
--	--	--	--	--





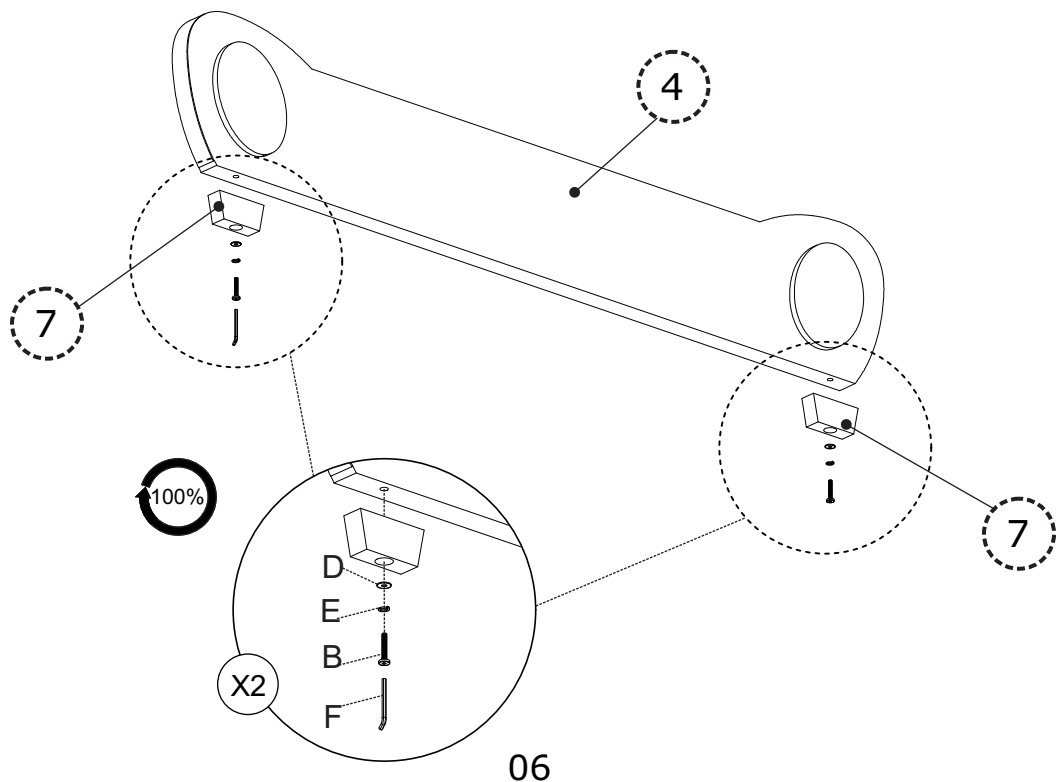

# STEP 2

B x 2 	D x 2 	E x 2 	F x 1 	
--	--	--	--	--





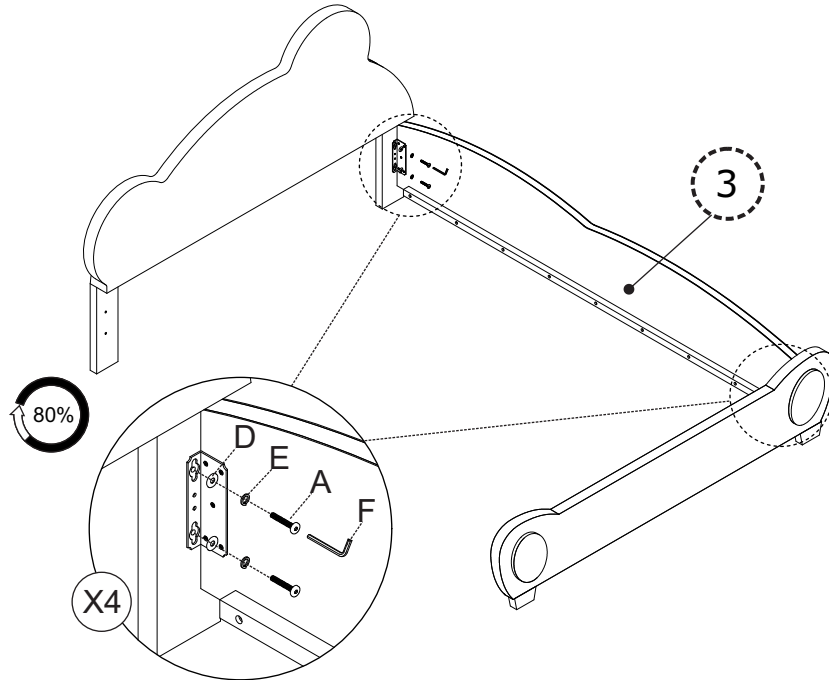

# STEP 3

C x 4 	D x 4 	E x 4 	F x 1 	
--	--	--	--	--



# STEP 4

C x 4 	D x 4 	E x 4 	F x 1 	
--	--	--	--	--

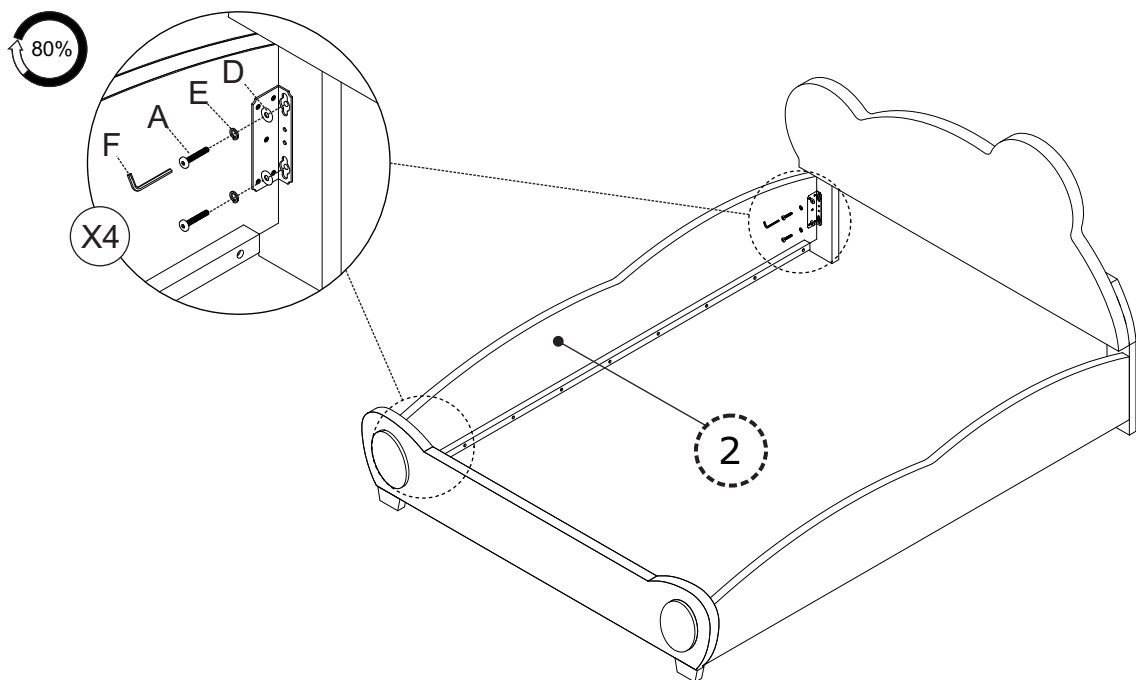

# STEP 5

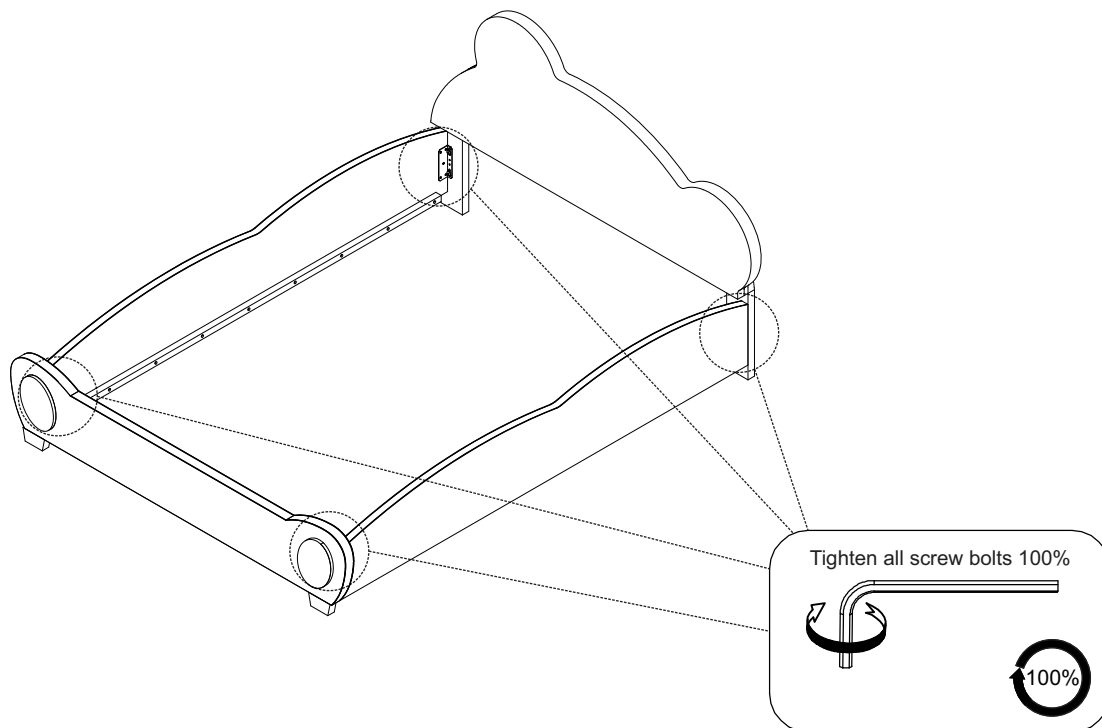
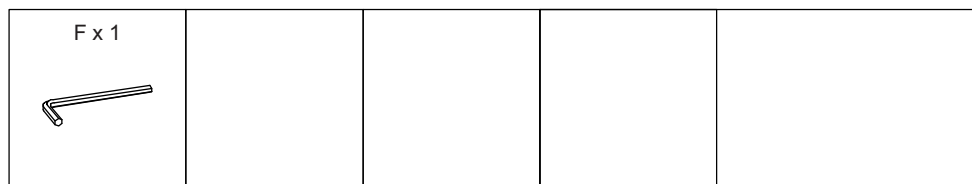

# STEP 6

