

# 70" bookcase Instruction Manual

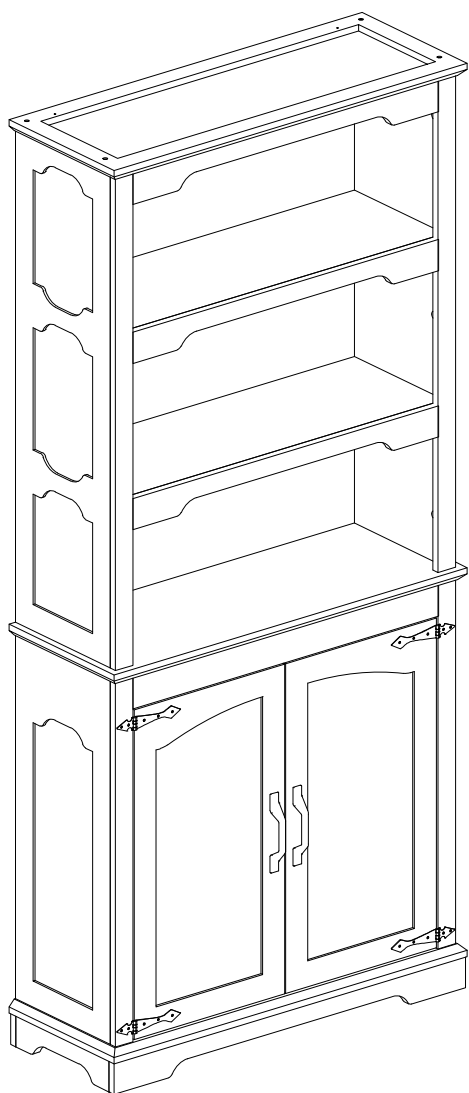

OR

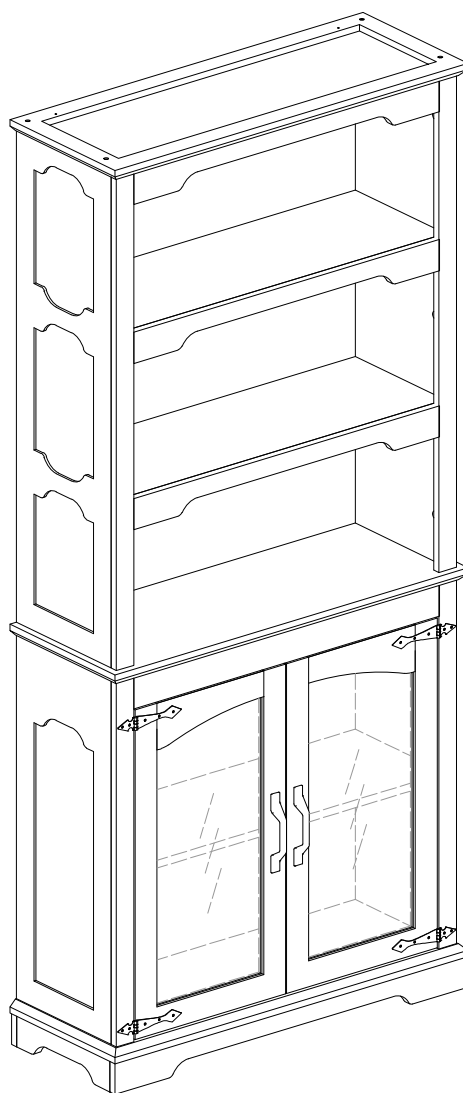

70" bookcase

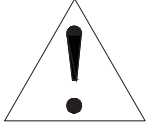

## **WARNING**

**Unexpected assembly or improper use may result in serious injury or even death. Please be sure to follow the following safety tips:**

**Keep out of reach of children:** During assembly, keep all parts away from children or infants to prevent accidental ingestion or injury.

**Fix the product:** Products placed against the wall, any height greater than 23.6 inches, must be securely fixed to the wall to ensure that there are no hidden wires, water pipes or gas pipes in the area to be drilled.

**Anti-tipping tips:** The use of anti-tipping devices can reduce the risk of tipping, but it cannot completely eliminate it.

**Weight limit:** Do not place heavy objects unless this product is explicitly designed to bear weight.







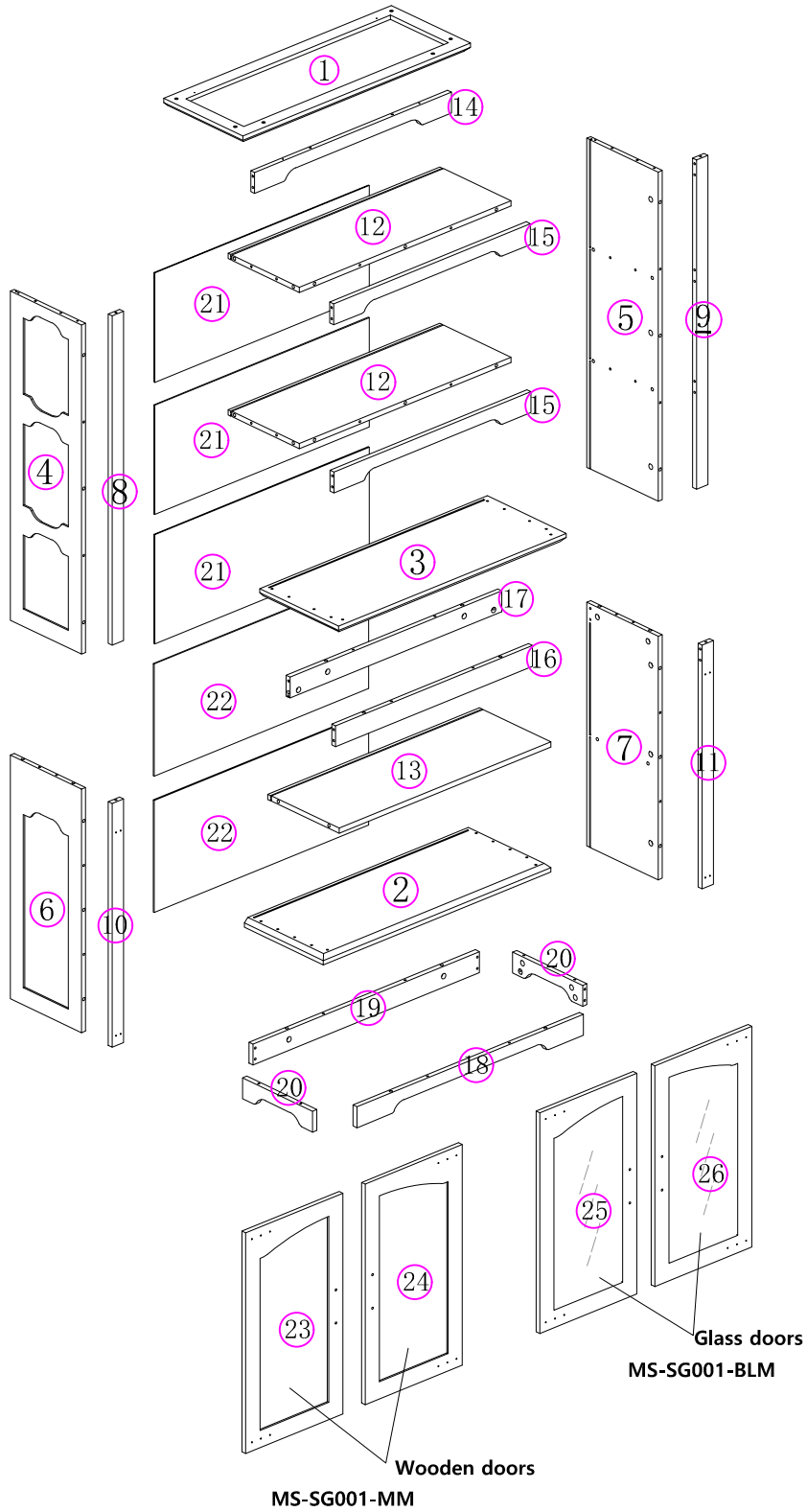

**Heavy object placement:** Place the heaviest items on the lowest shelf to maintain a stable center of gravity.

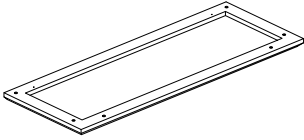
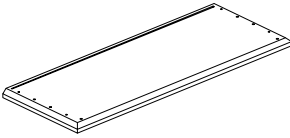
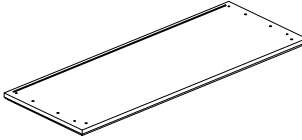
**No climbing:** Children are strictly prohibited from climbing or knocking on drawers, doors or shelves to avoid tipping or accidental injury.

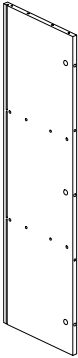
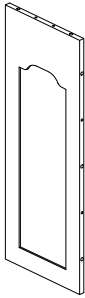

# Explosion Diagram

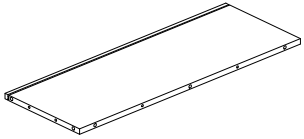
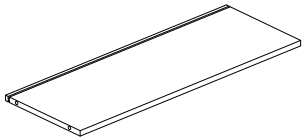
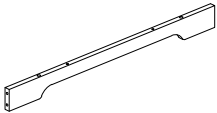
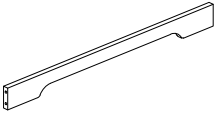
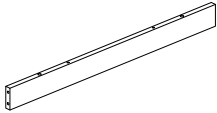

# Parts and Operation Elements

			
① 1Pc	② 1Pc	③ 1Pc	④ 1Pc
			
⑤ 1Pc	⑥ 1Pc	⑦ 1Pc	⑧ 1Pc
			
⑨ 1Pc	⑩ 1Pc	⑪ 1Pc	⑫ 2Pcs
			
⑬ 1Pc	⑭ 1Pc	⑮ 2Pcs	⑯ 1Pc

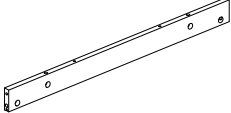
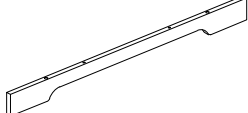
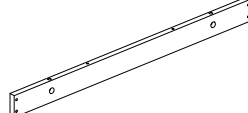
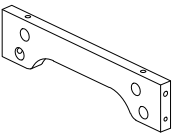
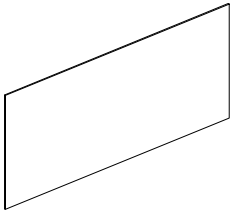
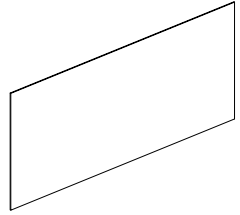
# Parts and Operation Elements

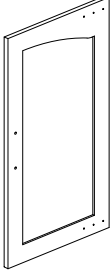
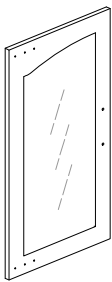
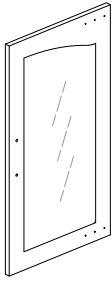
			
⑰ 1Pc	⑱ 1Pc	⑲ 1Pc	⑳ 2Pcs
			
⑳ 3Pcs	㉑ 2Pcs	㉓ 1Pc Wooden doors	㉔ 1Pc Wooden doors
		If you choose you will receive parts 23 and 24.	
			
㉕ 1Pc Glass doors	㉖ 1Pc Glass doors		
If you choose		you will receive parts 23 and 24.	



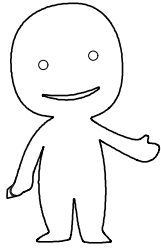



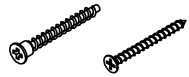
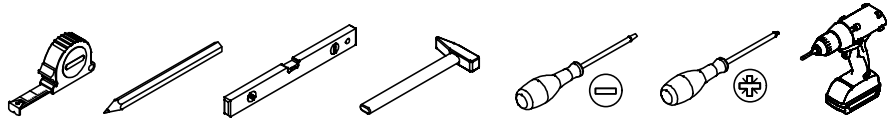



# HardWare

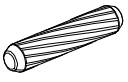
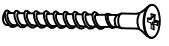
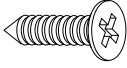

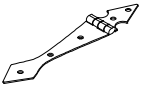
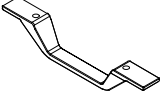
Please prepare the following tools



When installing, please carefully confirm whether each screw corresponds to the manual, accessories with similar shapes can be distinguished by size.

 $\phi 6 \times 36 \text{mm}$ Cam Bolt	 $\phi 15 \times 9.5$ Cam Lock	 $\phi 6 \times 30$	 $M4 \times 40$
<b>A</b> 52PCS+3PCS	<b>B</b> 52PCS+3PCS	<b>C</b> 78PCS +3PCS	<b>D</b> 14PCS+1PC
 $\phi 3.5 \times 12$		 $M4 \times 10$	
<b>E</b> 2PCS	<b>F</b> 1PC	<b>G</b> 20PCS+2PCS	<b>H</b> 4PCS
	 $M5 \times 18 \text{mm}$		  (L1) x30    (L2) x30
<b>I</b> 2PCS	<b>J</b> 4PCS	<b>K</b> 26PCS+2PCS	<b>L</b> 30PCS +3PCS
M1x2    M2x2    M3x2  M4x6    M5x2 			
<b>M</b> 1SET			

# 1

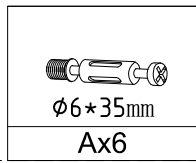
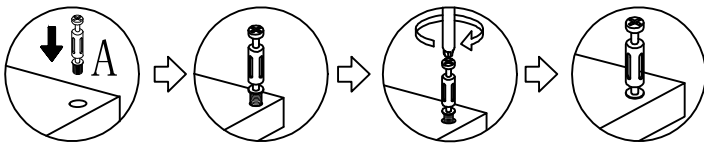
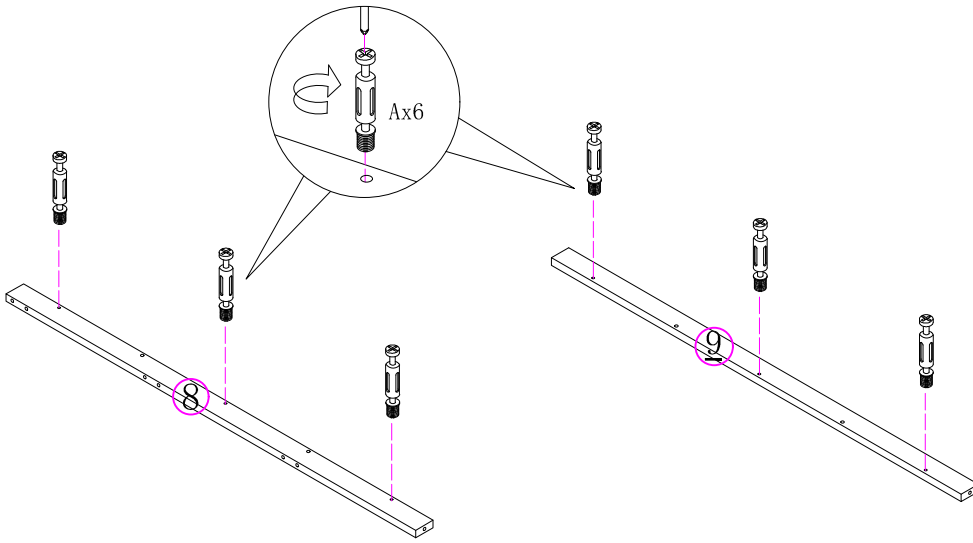

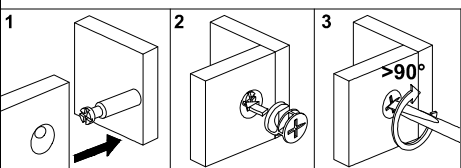
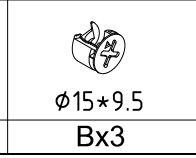
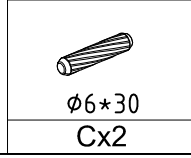
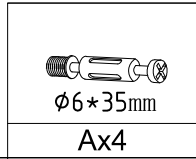
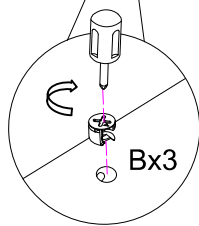
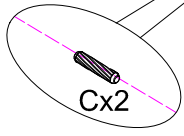
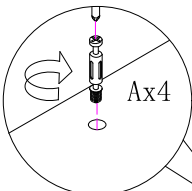
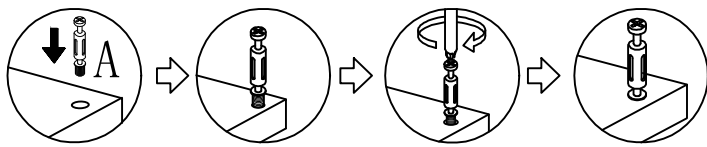
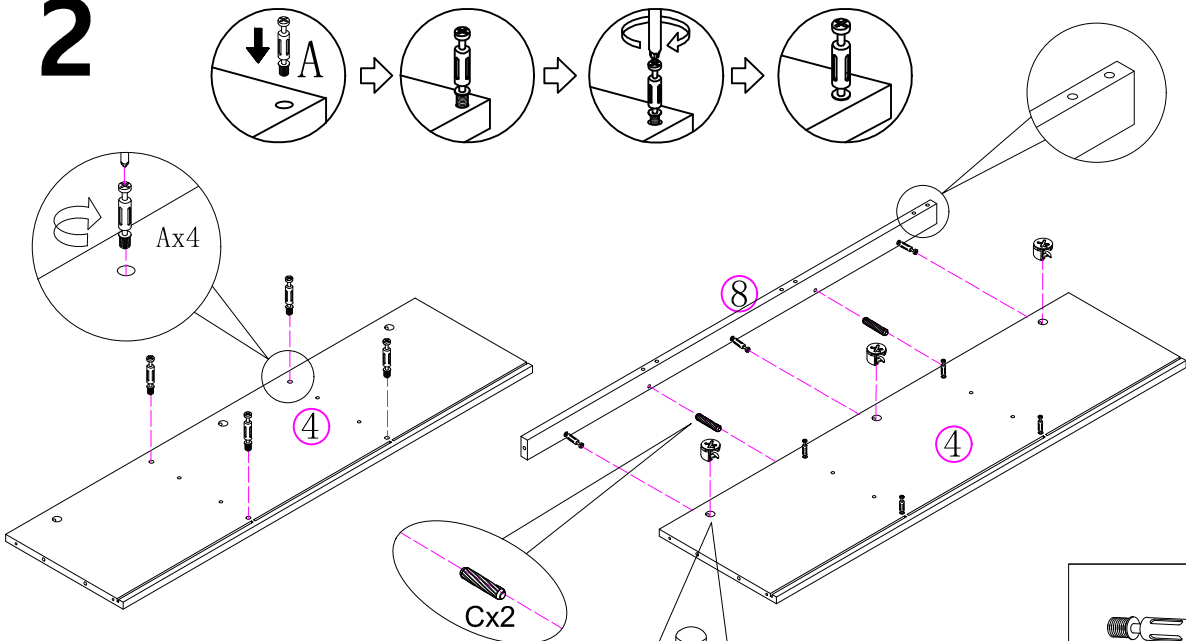

# 2

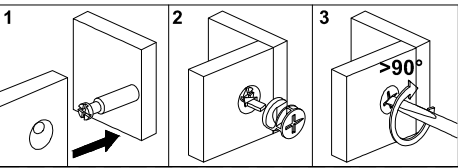
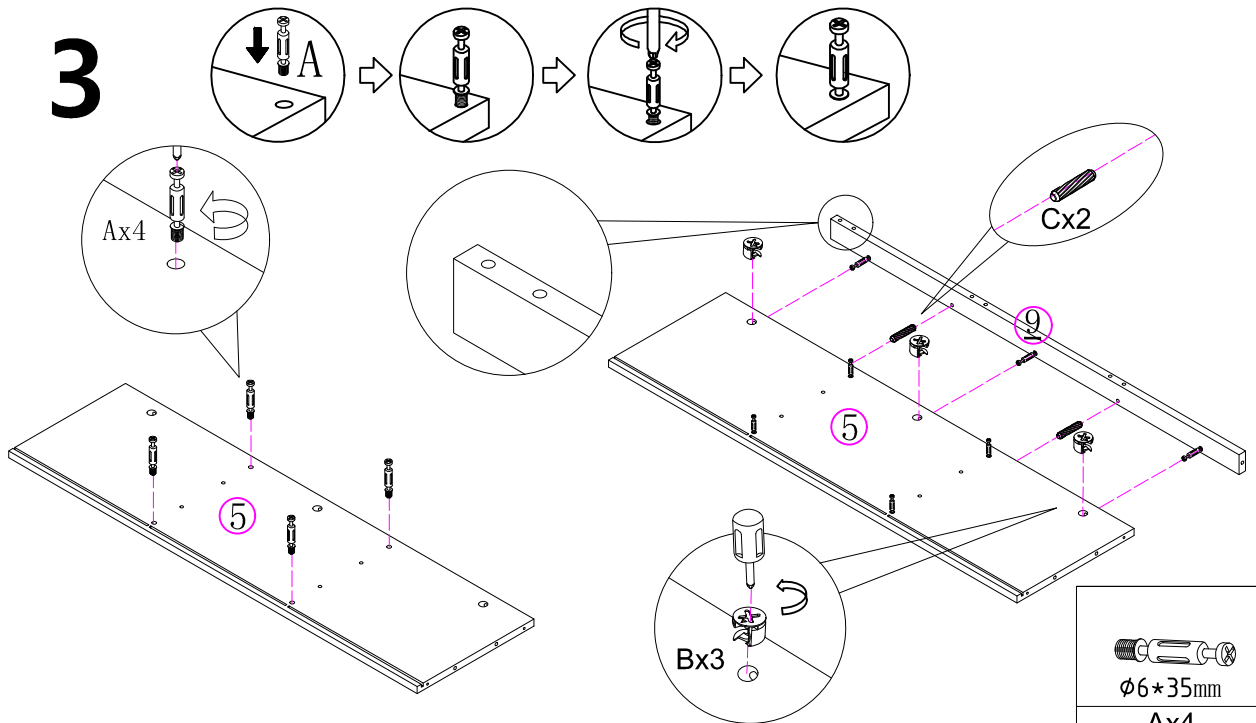

# 3



 φ6*35mm Ax4	 φ6*30 Cx2	 φ15*9.5 Bx3
---	--	--

# 4

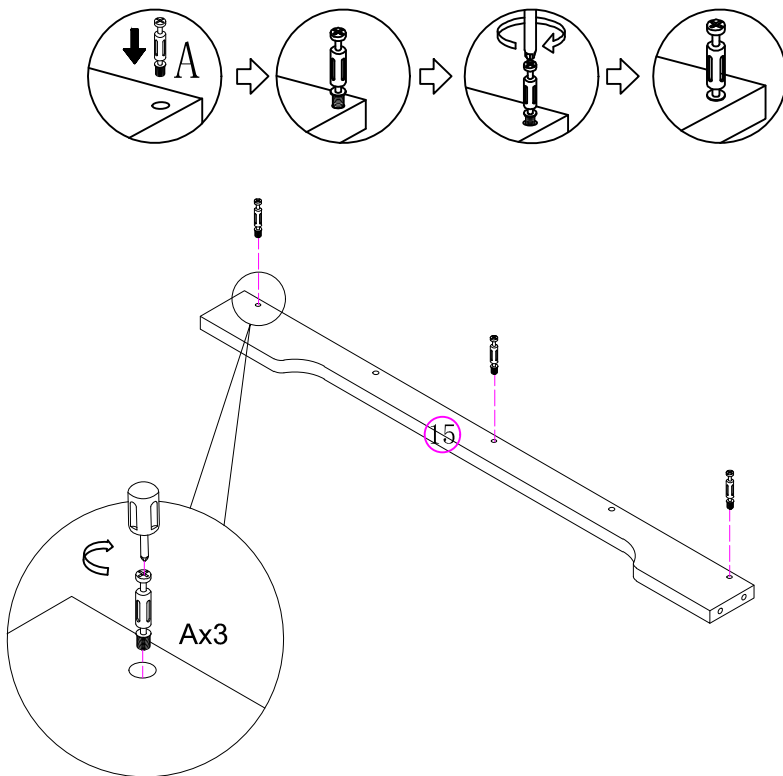

# X2

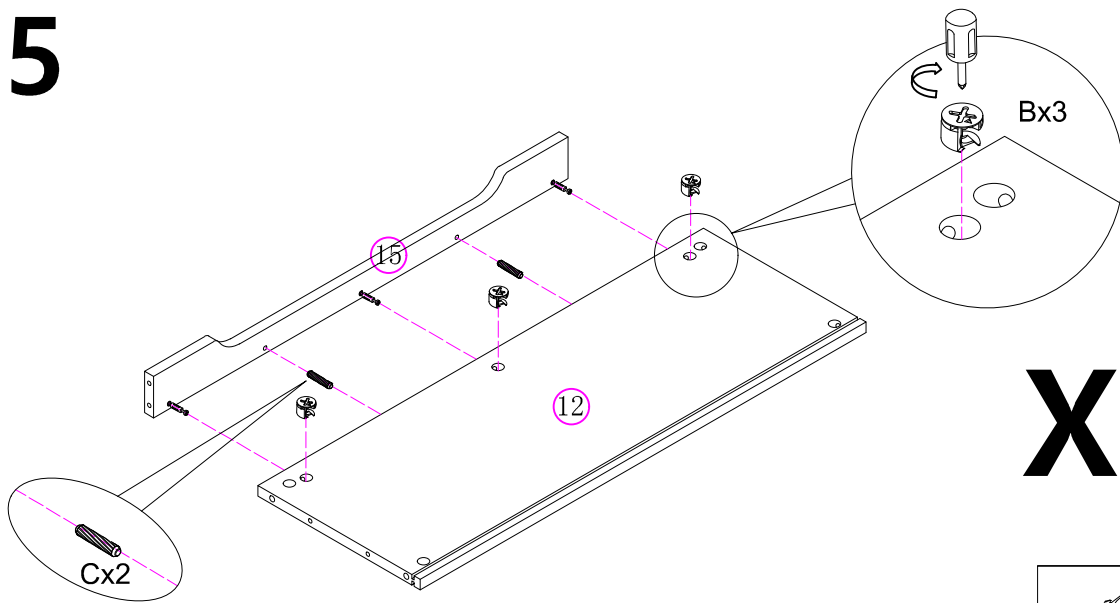

 φ6*35mm Ax6
---

# 5



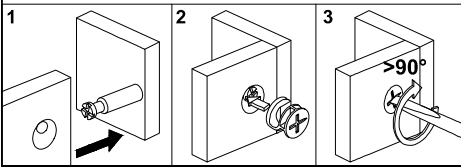

# X2



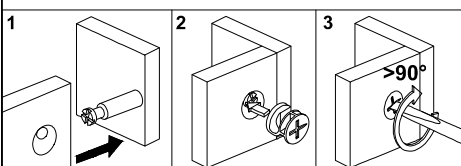
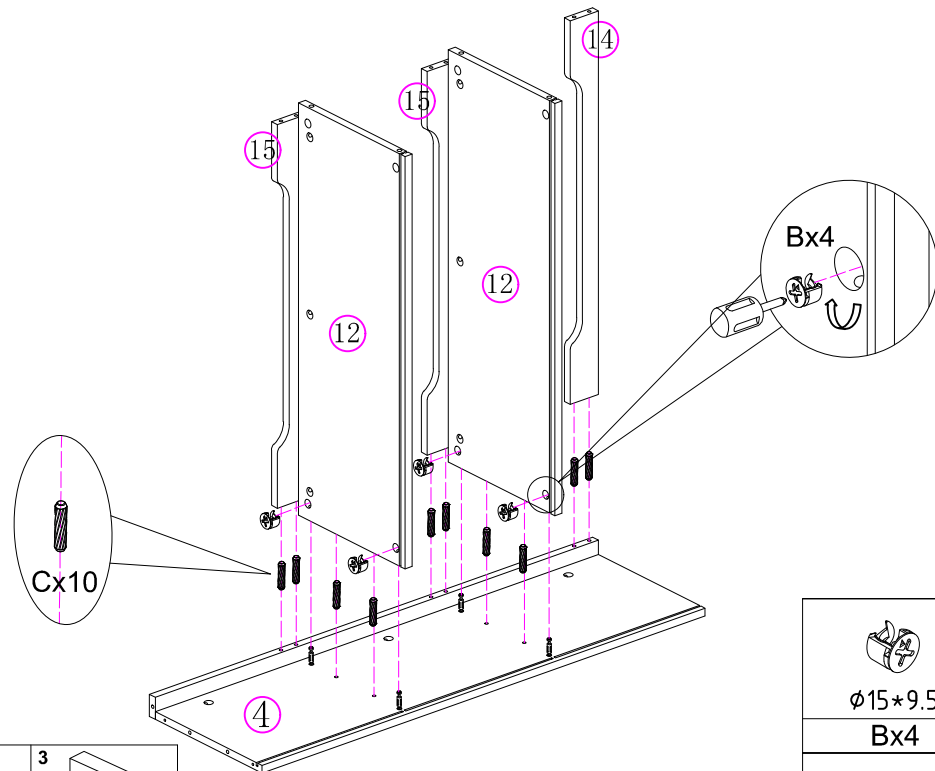

$\phi 15 \times 9.5$
Bx6

$\phi 6 \times 30$
Cx4



# 6

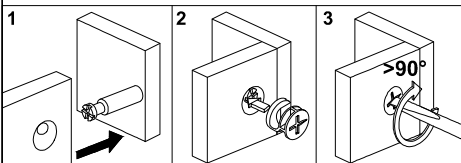
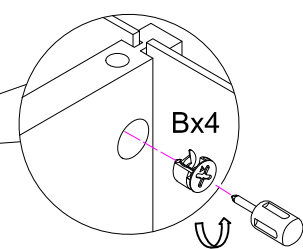
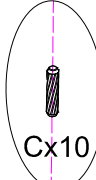
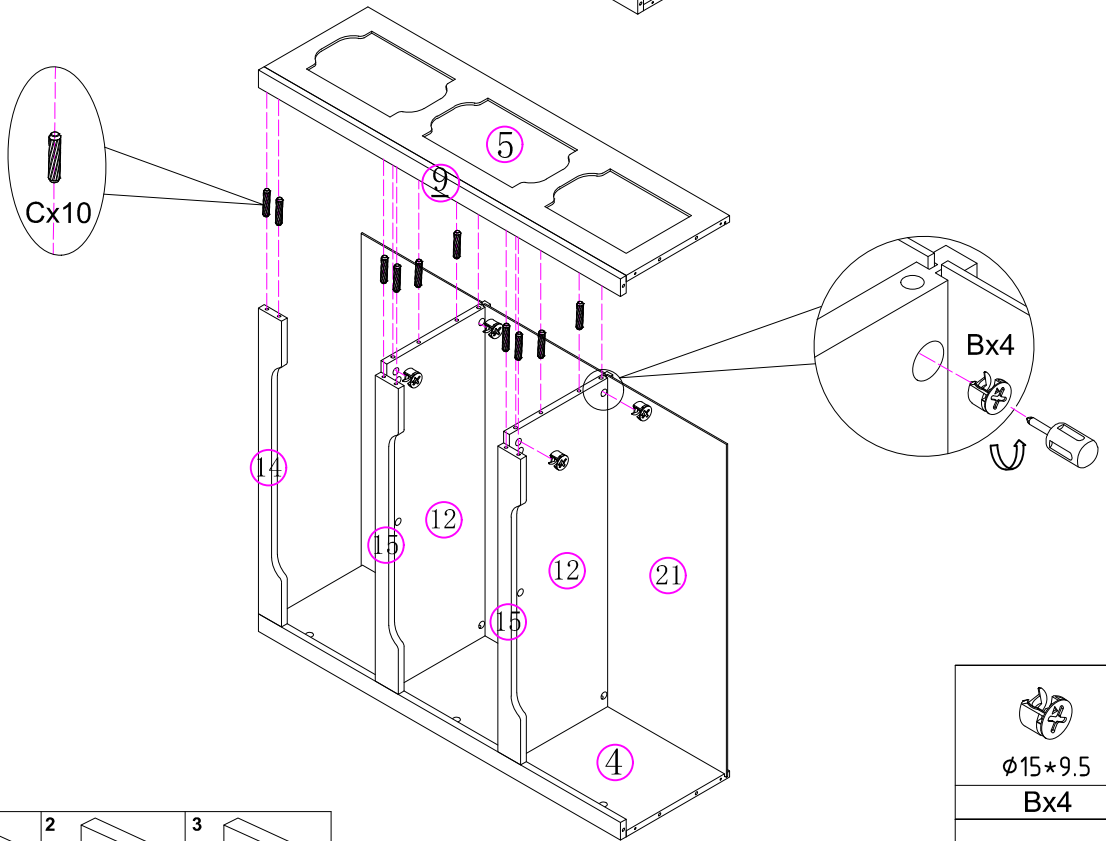
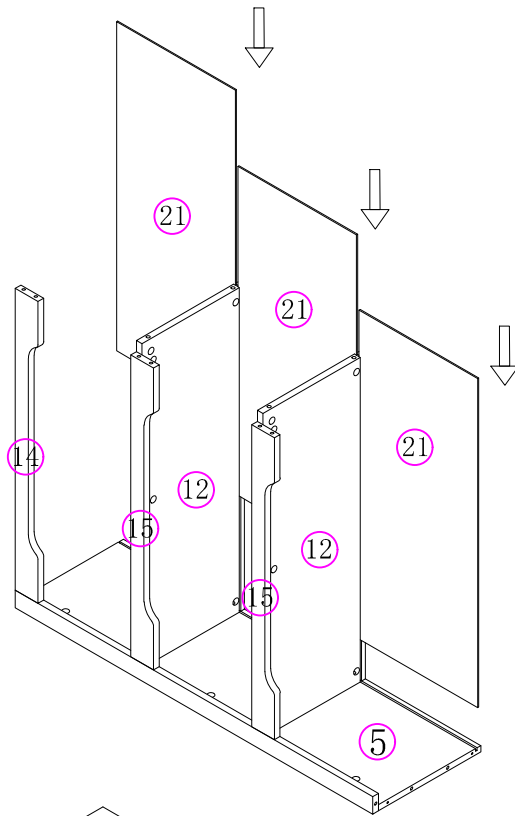



$\phi 15 \times 9.5$
Bx4

$\phi 6 \times 30$
Cx10

# 7



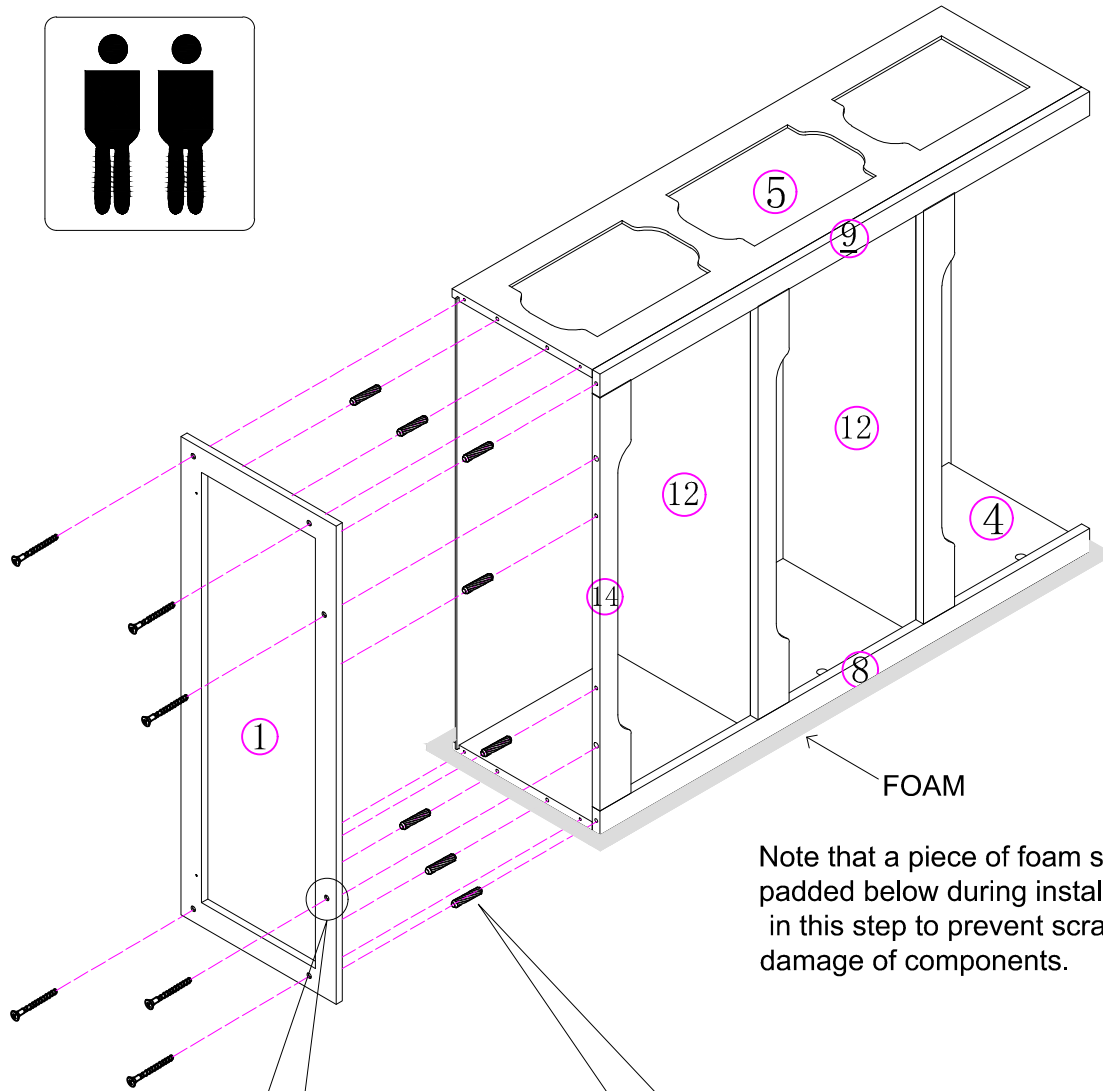

Ø15x9.5 Bx4

Ø6x30 Cx10



# 8

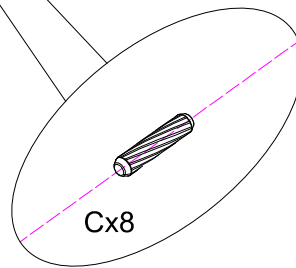
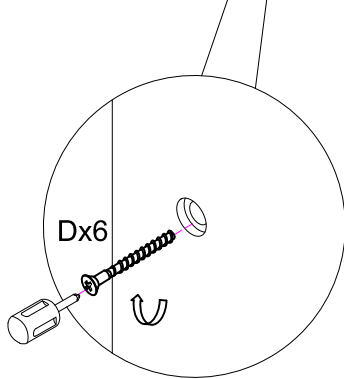

FOAM

Note that a piece of foam shall be padded below during installation in this step to prevent scratching damage of components.



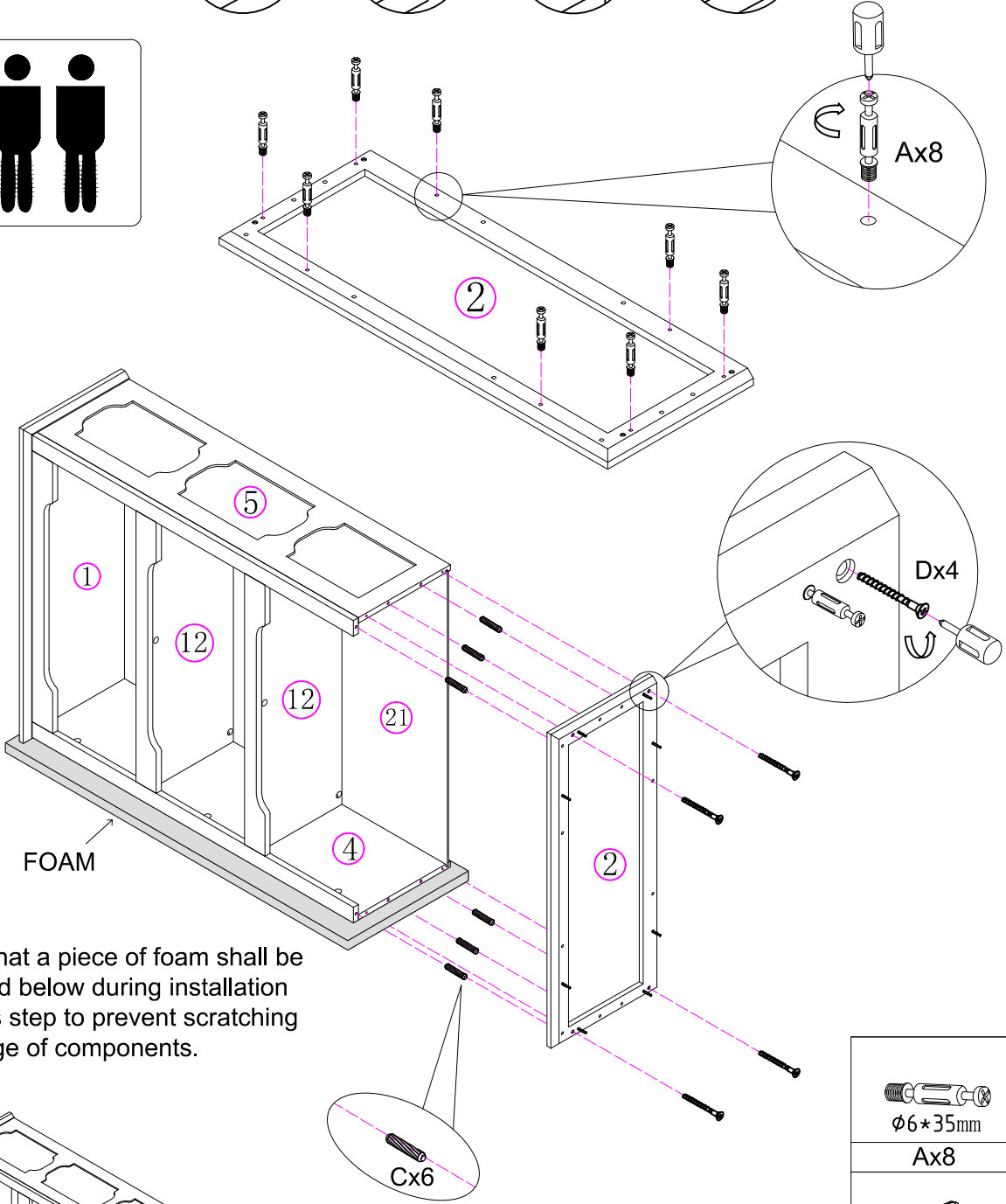
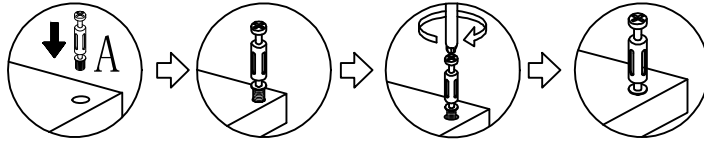
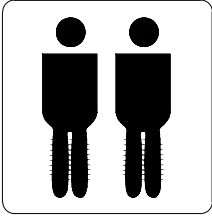

Ø6*30
Cx10

M4*40
Dx6

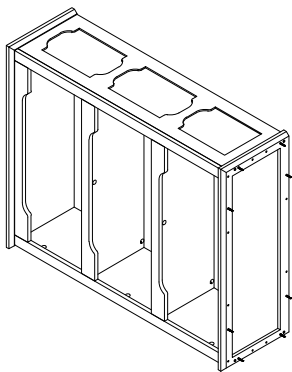

# 9



Note that a piece of foam shall be padded below during installation in this step to prevent scratching damage of components.





Partially assembled

Ø6*35mm
Ax8

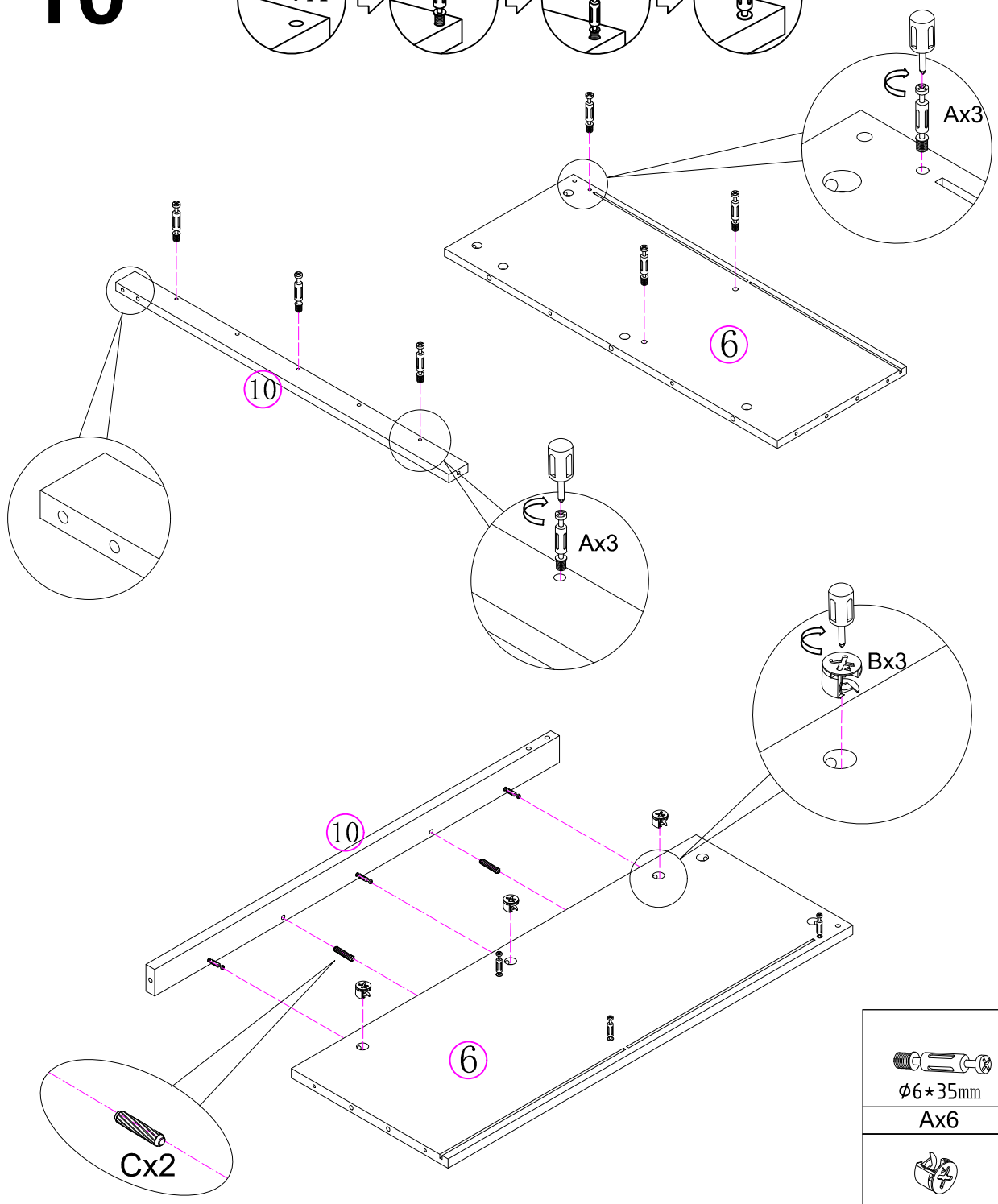
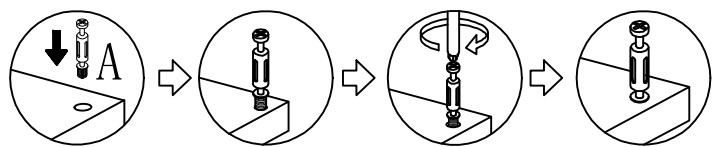
Ø6*30
Cx6

M4*40
Dx4

# 10

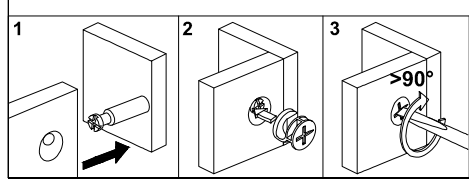



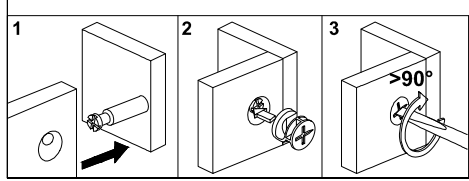
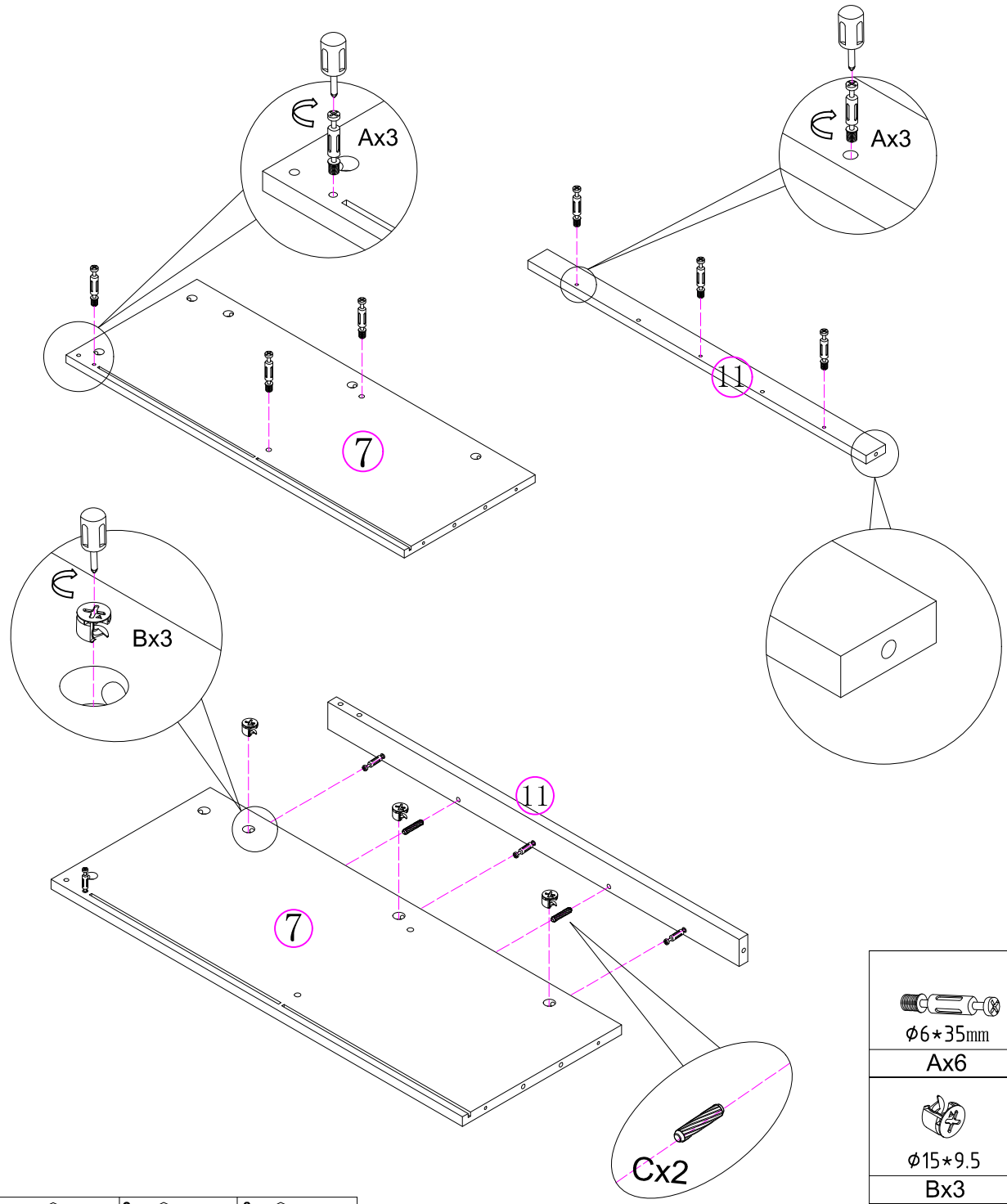
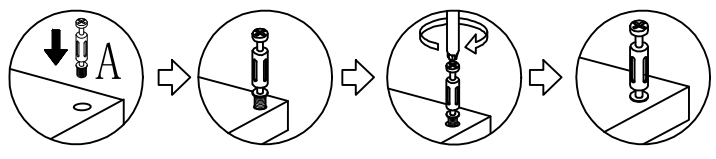

$\phi 6 \times 35\text{mm}$
Ax6

$\phi 15 \times 9.5$
Bx3

$\phi 6 \times 30$
Cx2







# 11



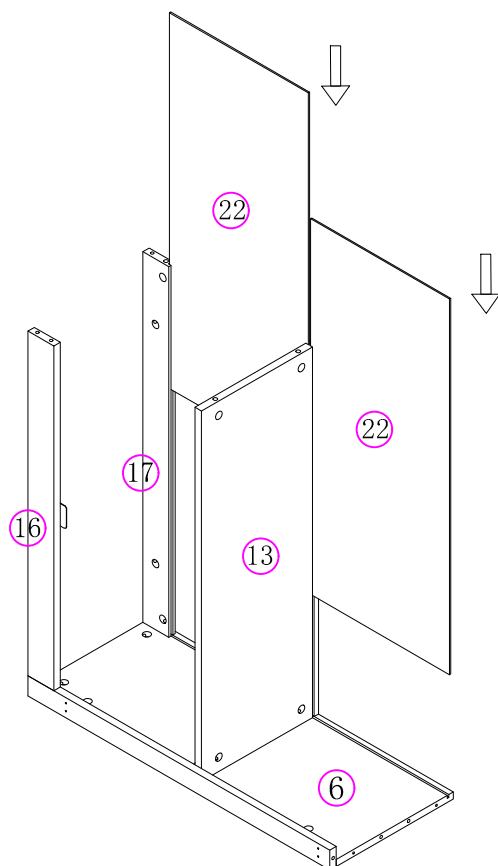
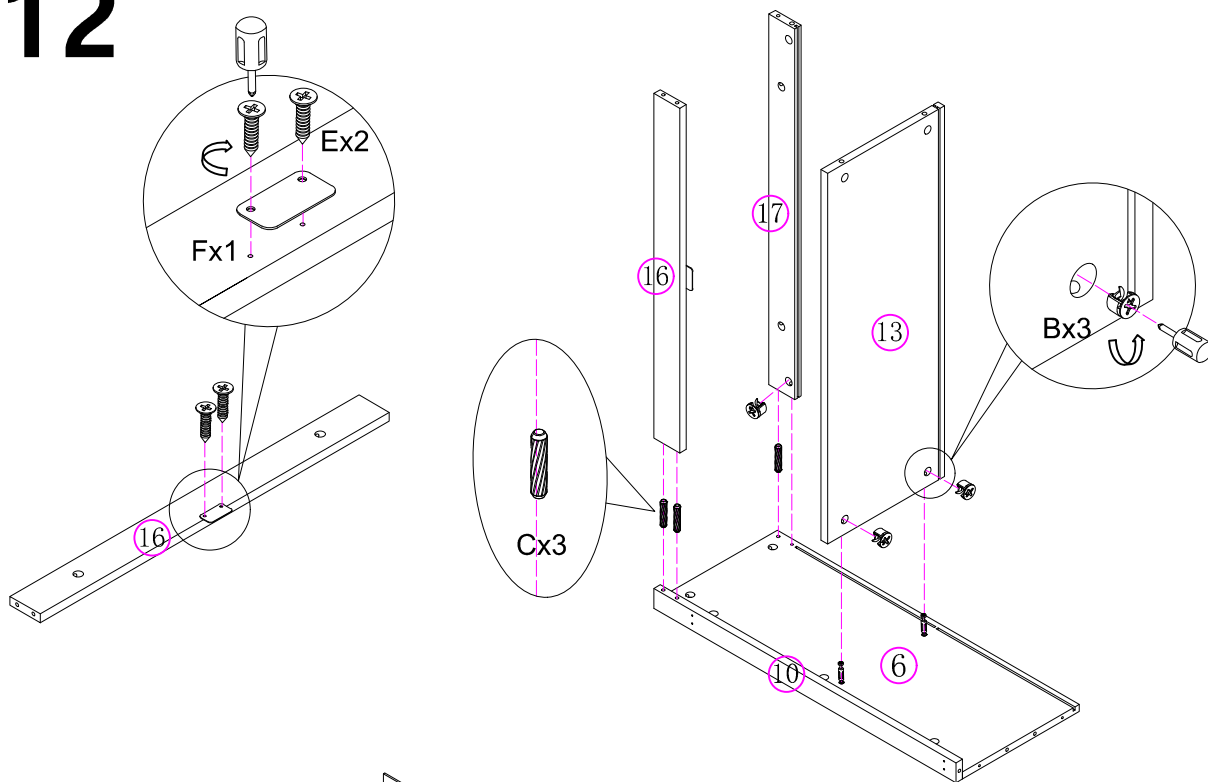

$\phi 6 \times 35\text{mm}$
Ax6

$\phi 15 \times 9.5$
Bx3

$\phi 6 \times 30$
Cx2

# 12

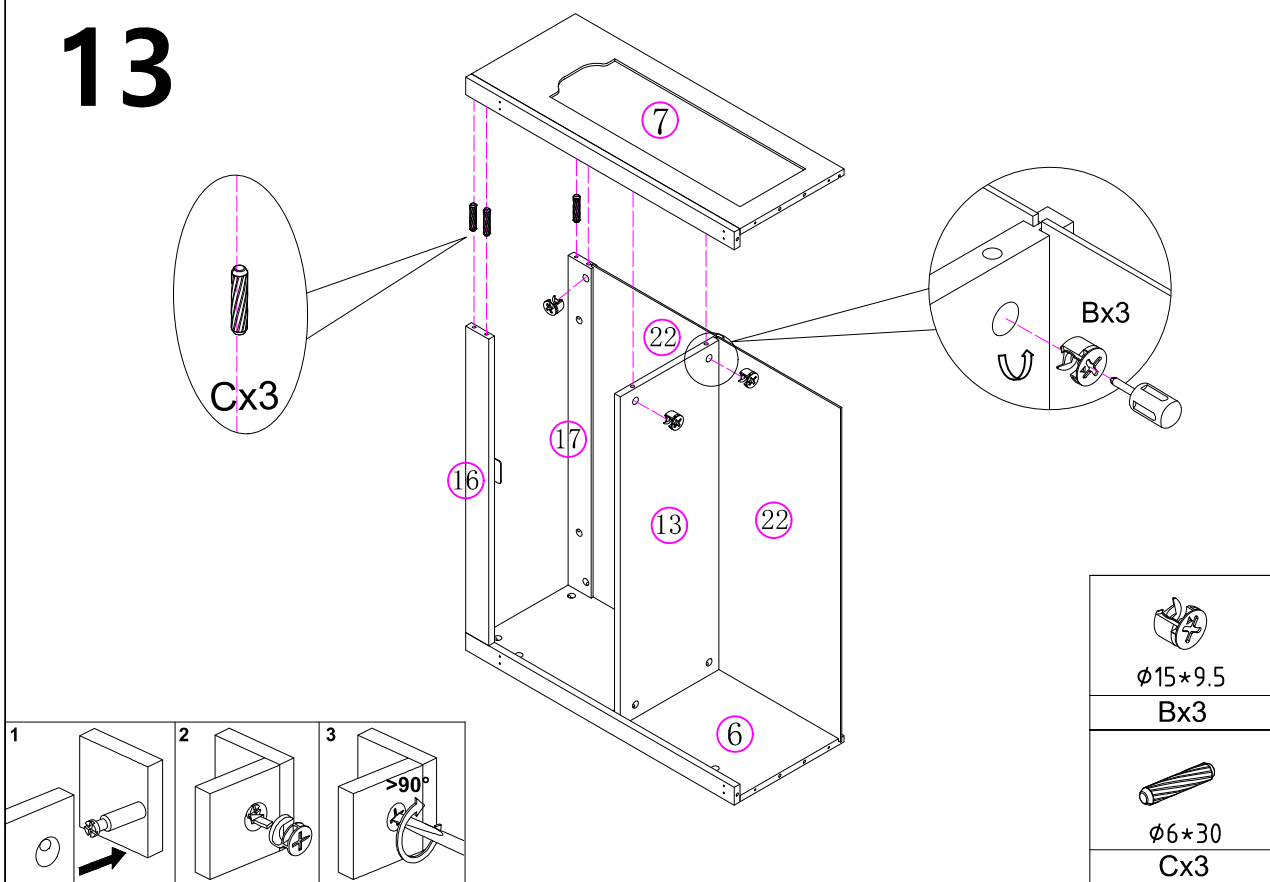



$\phi 15 \times 9.5$ <b>Bx3</b>

$\phi 6 \times 30$ <b>Cx3</b>

$\phi 3.5 \times 12$ <b>Ex2</b>

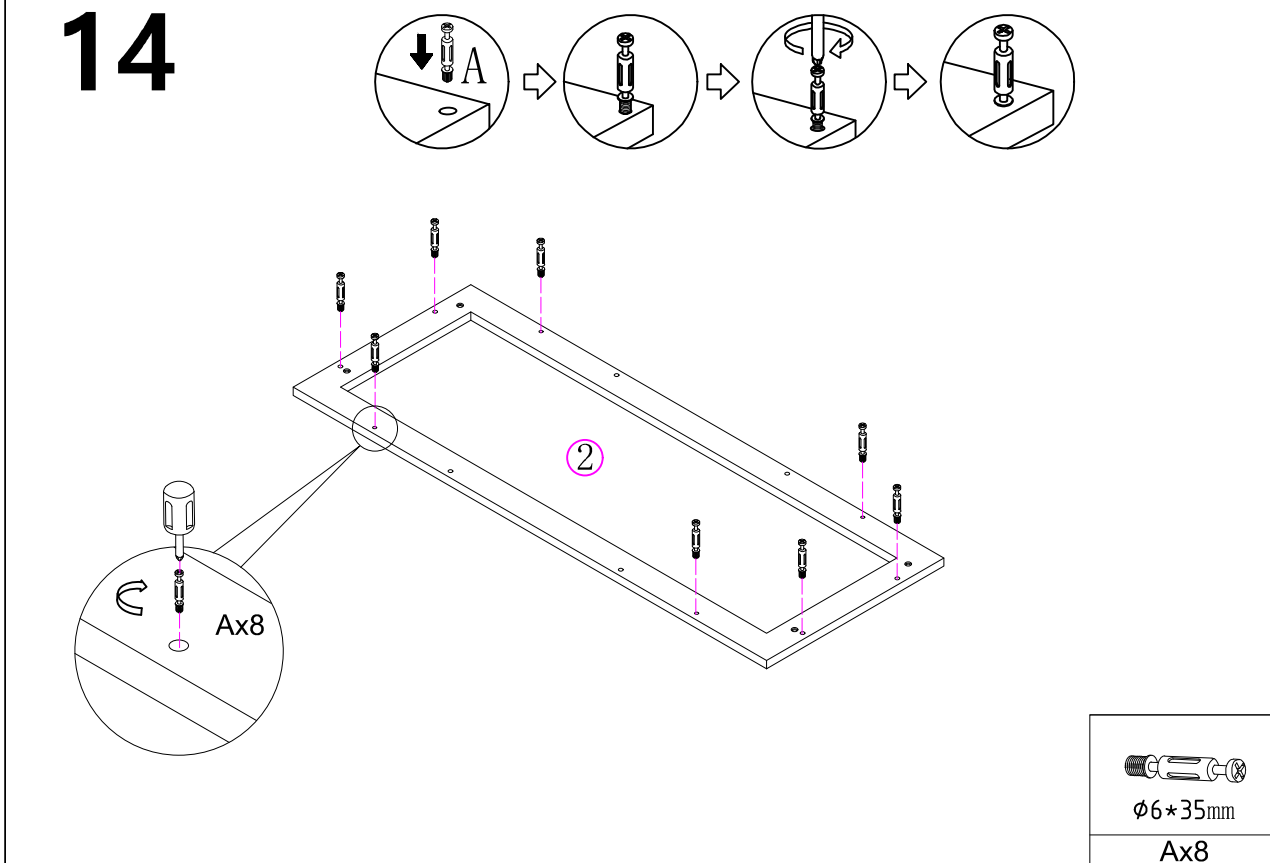
<b>Fx1</b>

# 13





# 14

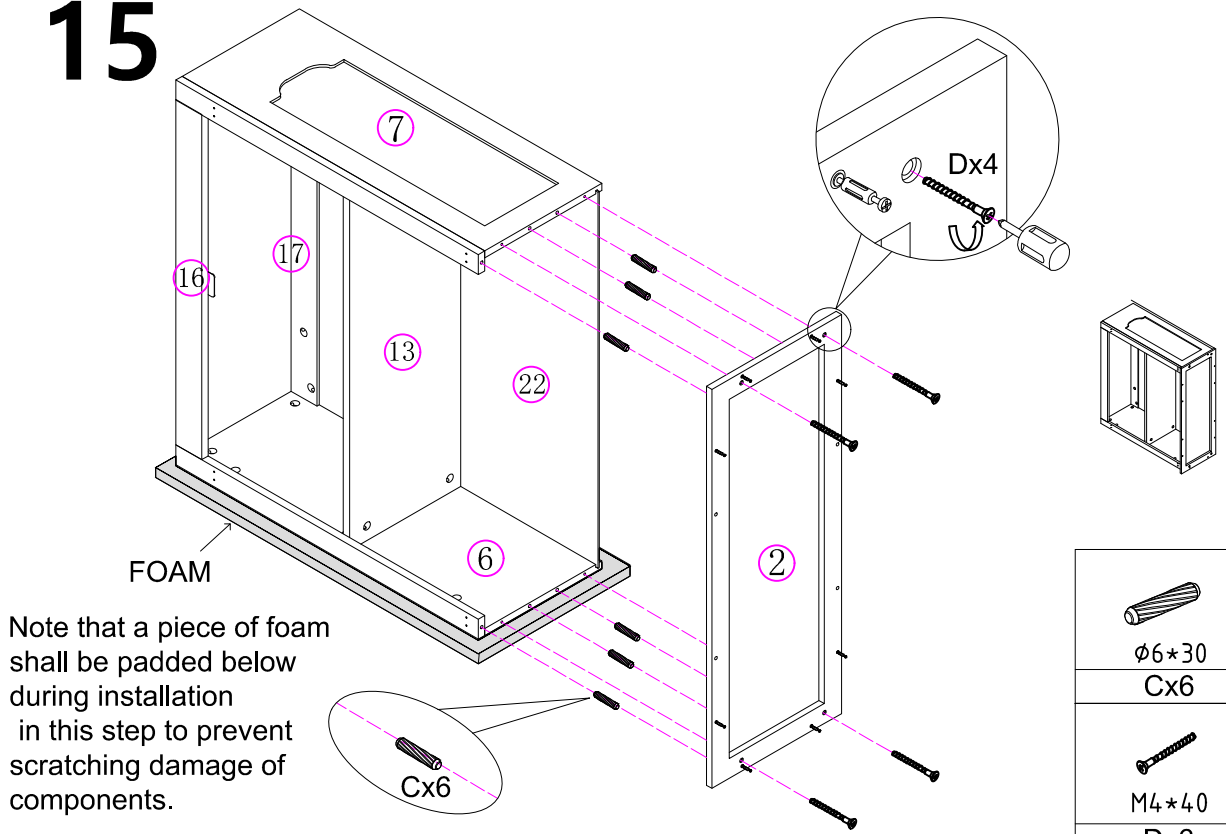

# 15



Note that a piece of foam shall be padded below during installation in this step to prevent scratching damage of components.

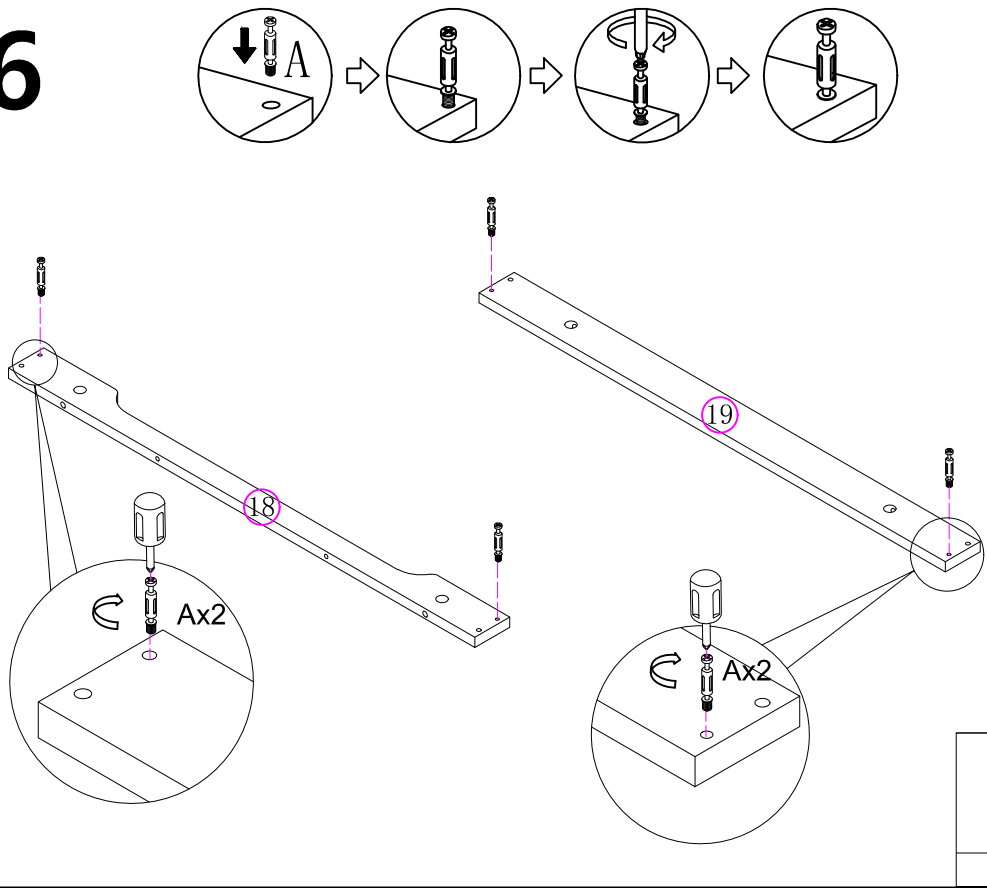

φ6*30 Cx6

M4*40 Dx6



# 16

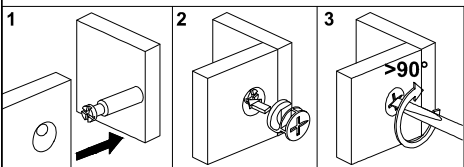
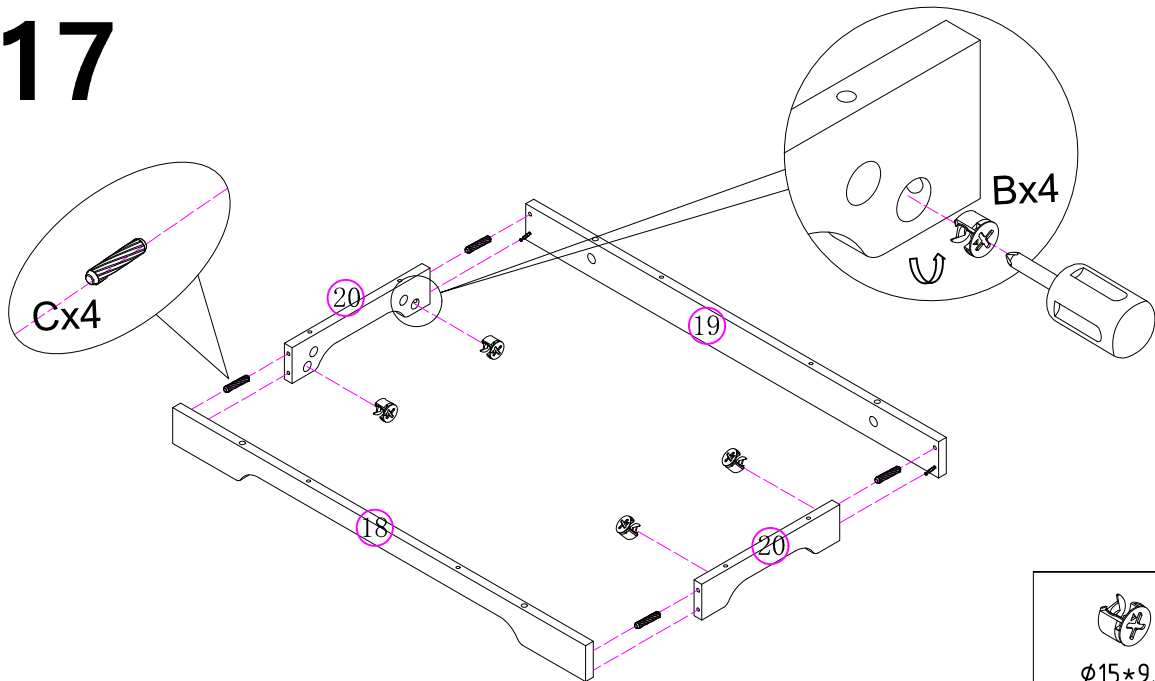



φ6*35mm Ax4

# 17





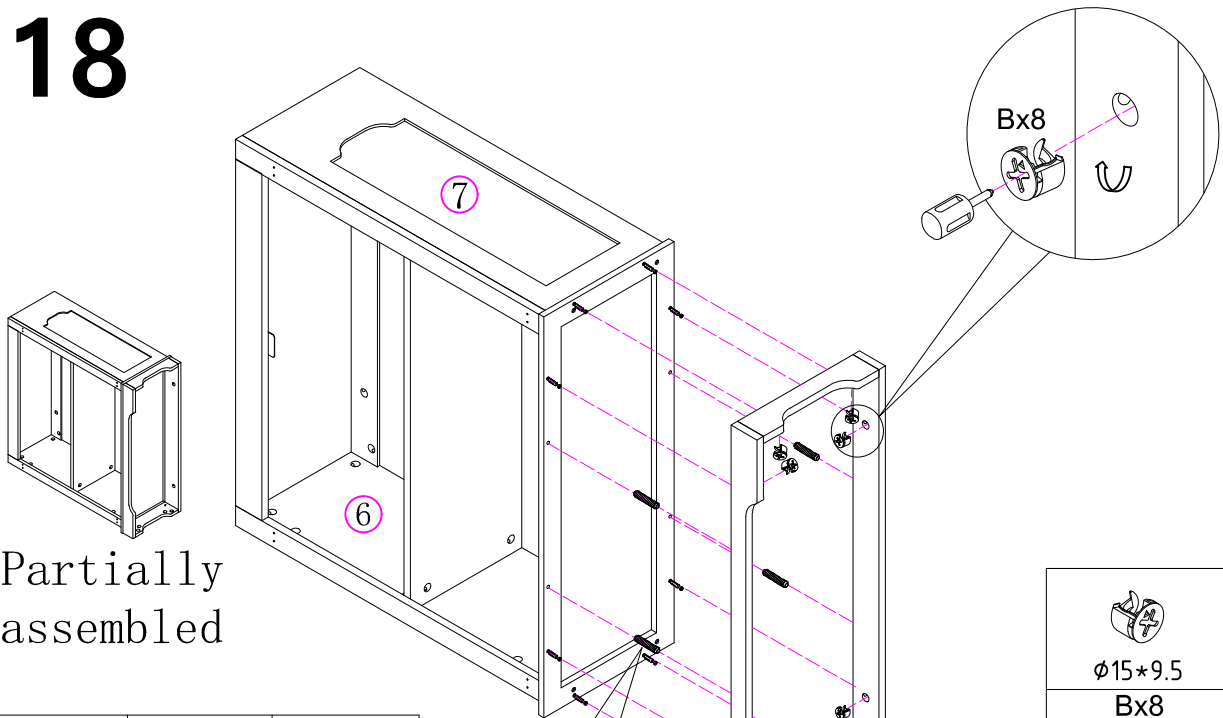

ø15*9.5
Bx4

ø6*30
Cx4

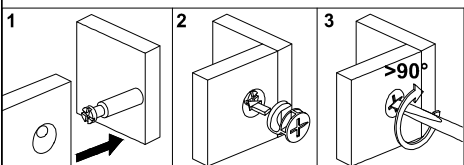
# 18



Partially assembled



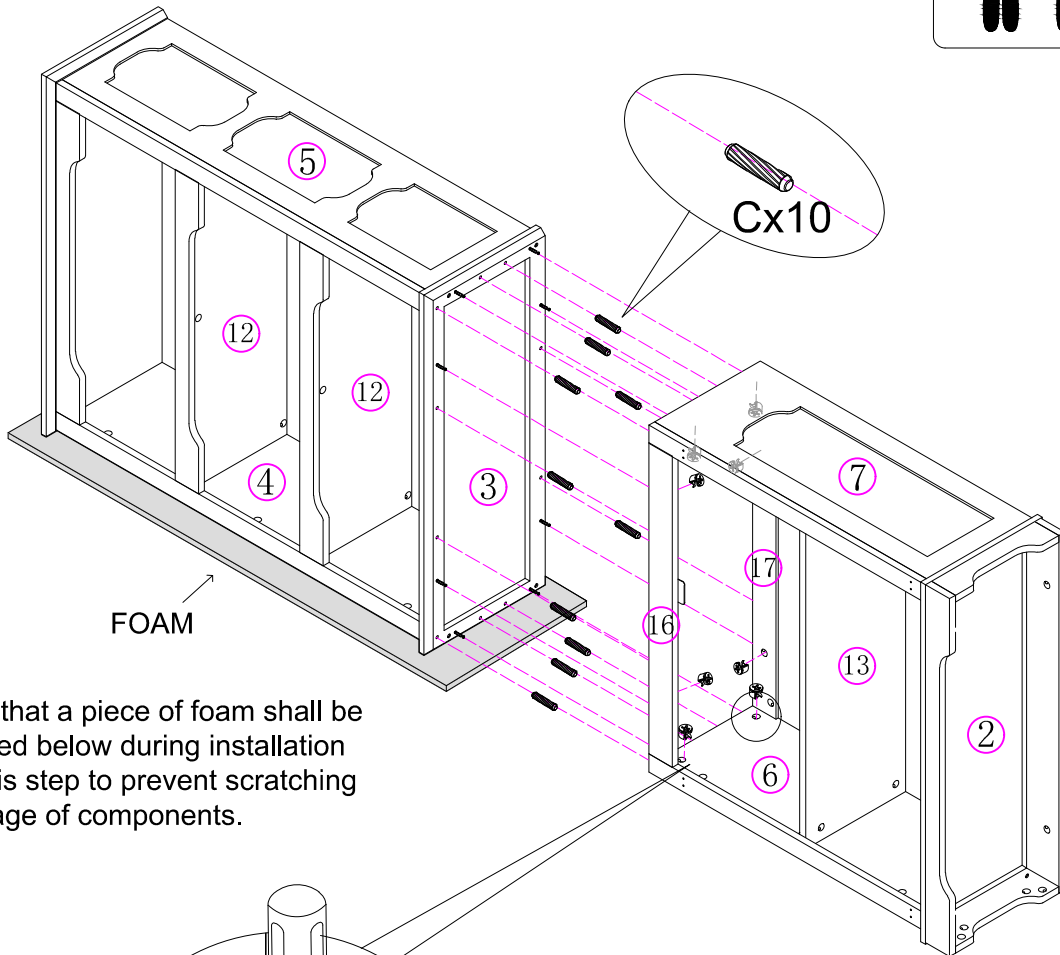
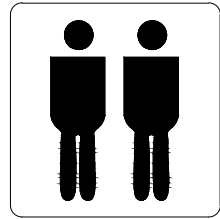

ø15*9.5
Bx8

ø6*30
Cx4

# 19

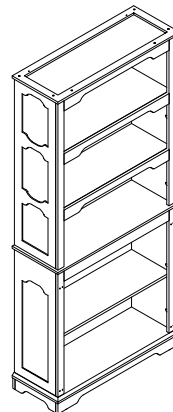
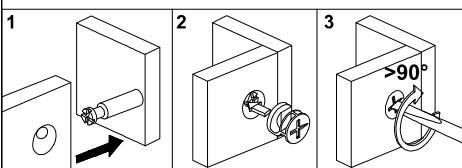
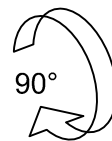
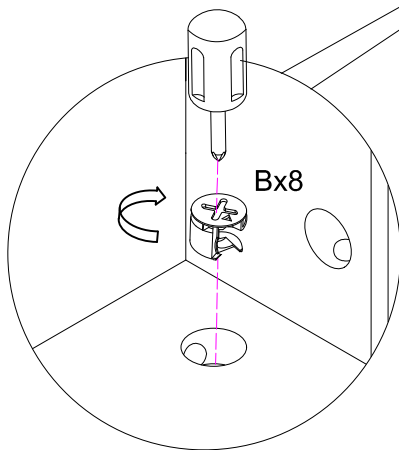

Note that a piece of foam shall be padded below during installation in this step to prevent scratching damage of components.





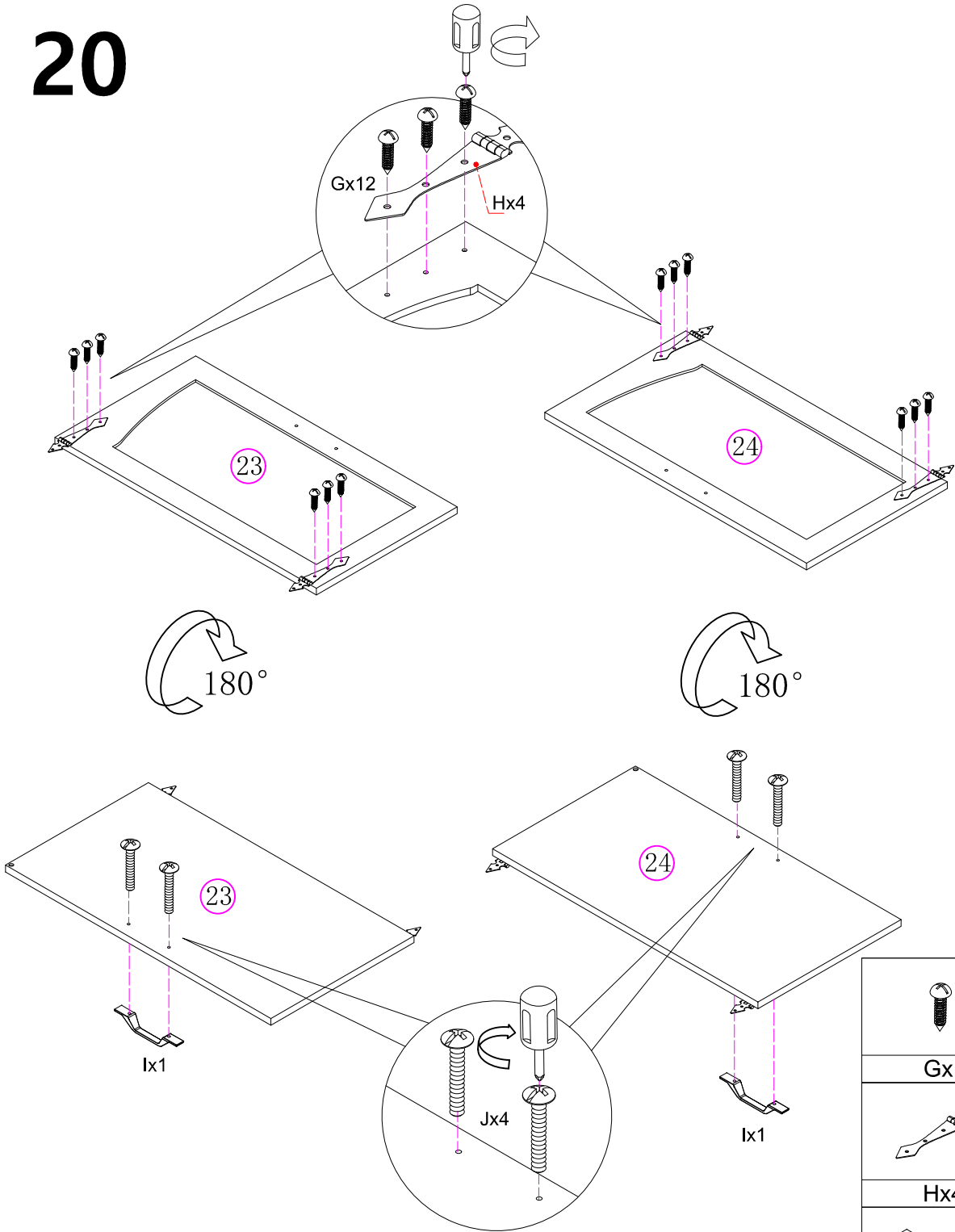

Ø15*9.5 Bx8
Ø6*30 Cx10

# 20

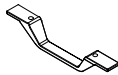

If you choose

you will receive parts 23 and 24.

Gx12

Hx4

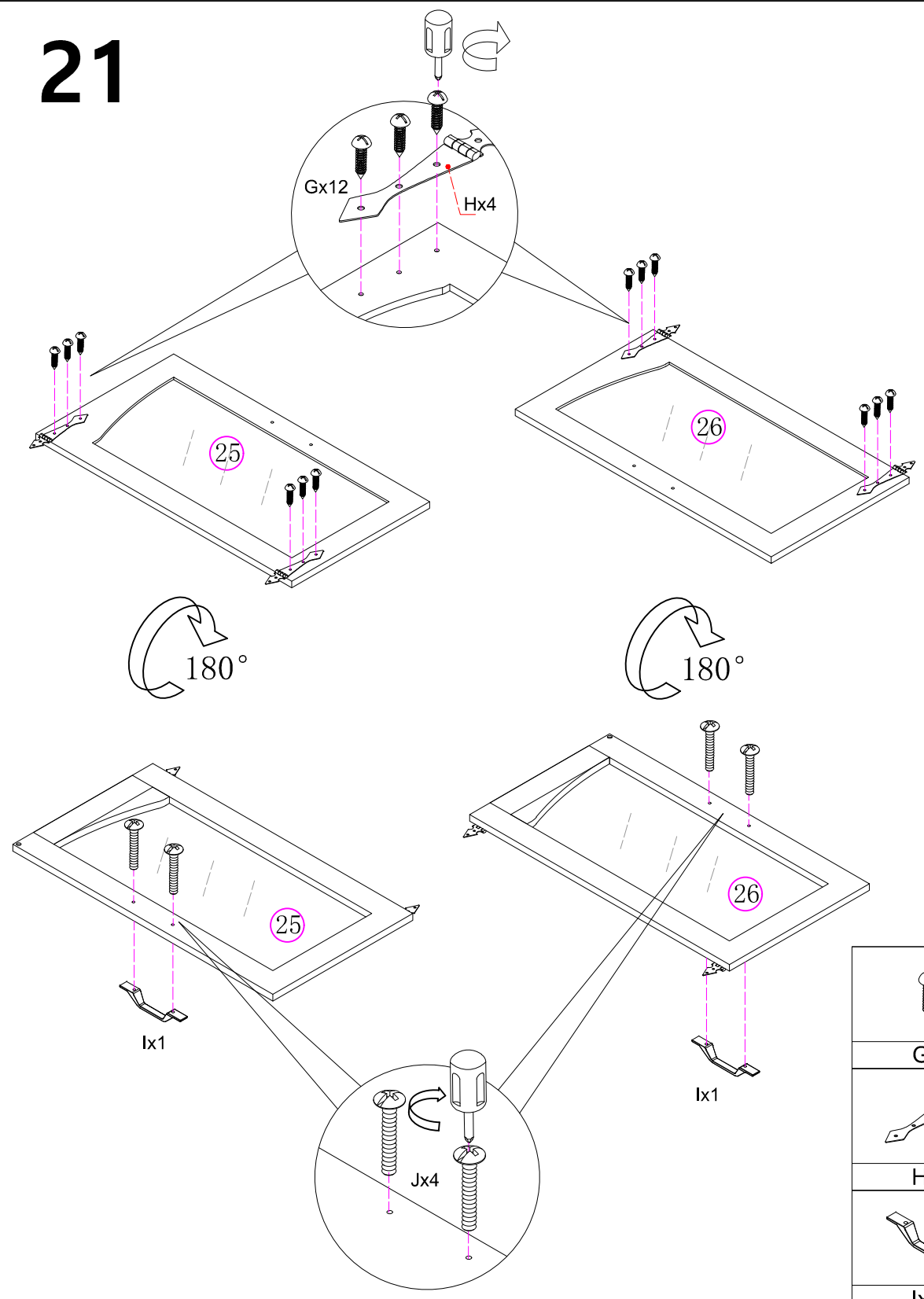
Ix2

Jx4

# 21



Gx12
Hx4
Ix1
Jx4

If you choose

you will receive parts 25 and 26.

# 22

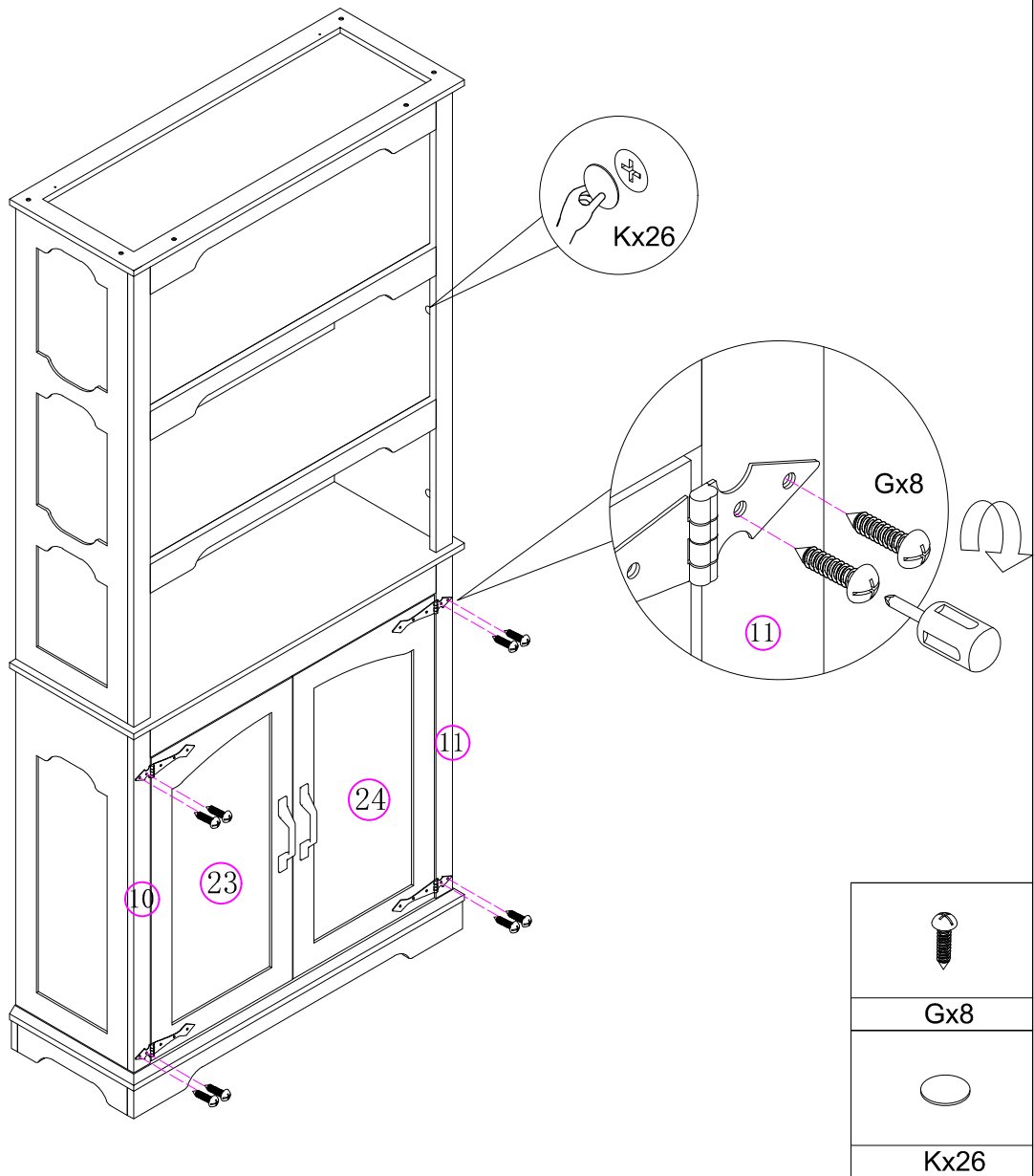

If you choose

you will receive parts 23 and 24.

# 23

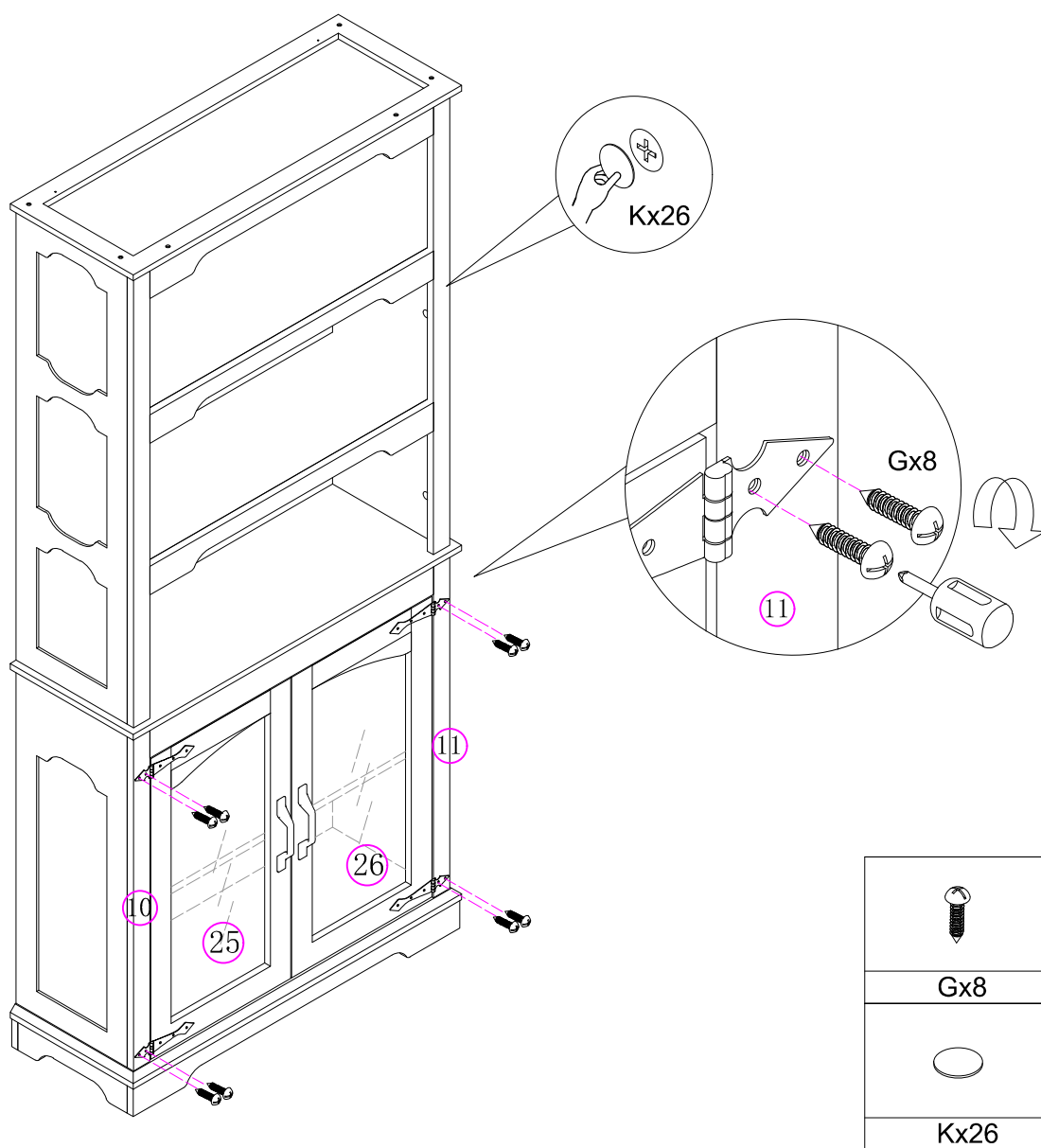

If you choose

you will receive parts 25 and 26.

# 24

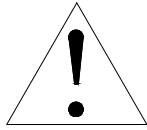



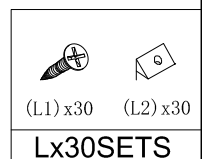
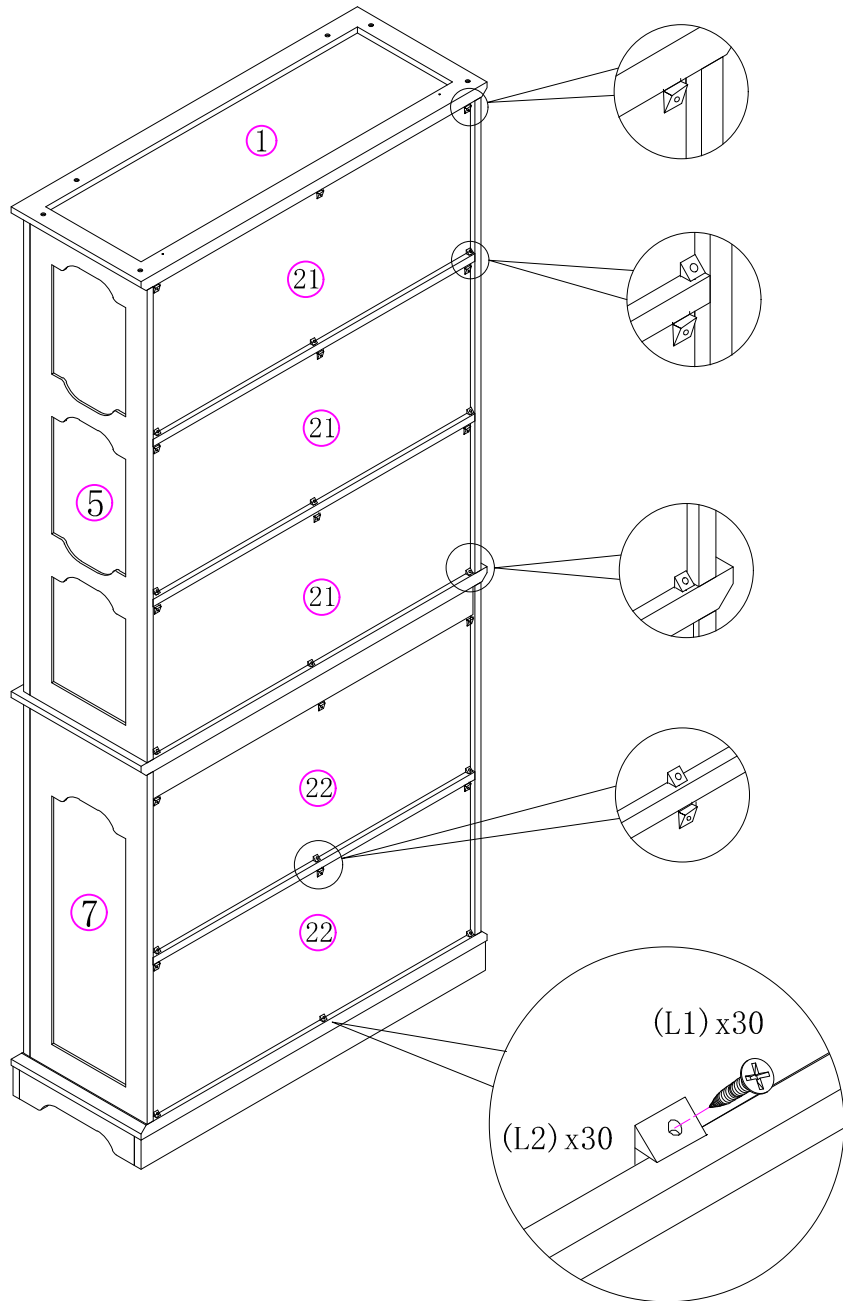

This step can make the product more stable and sturdy.

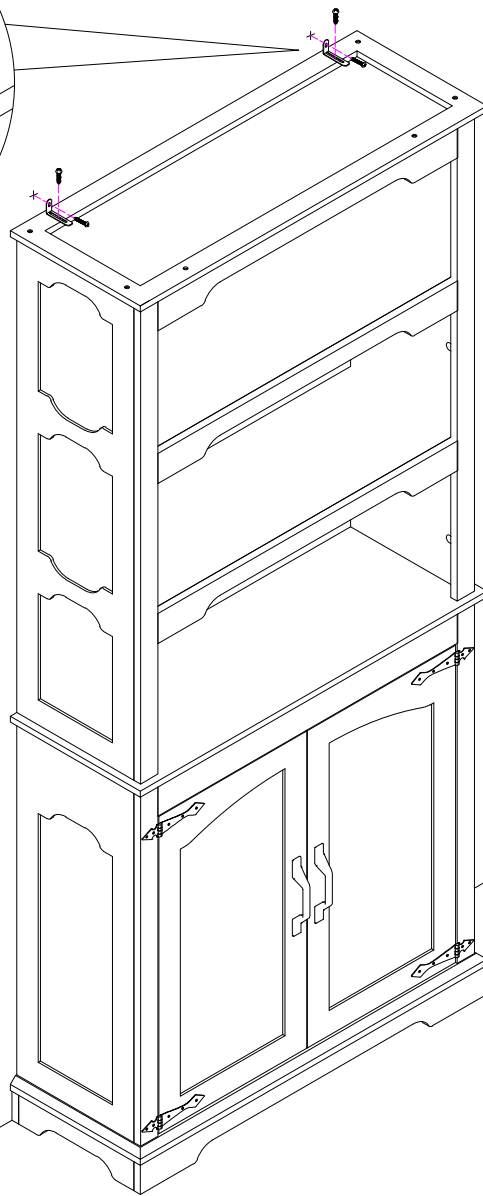
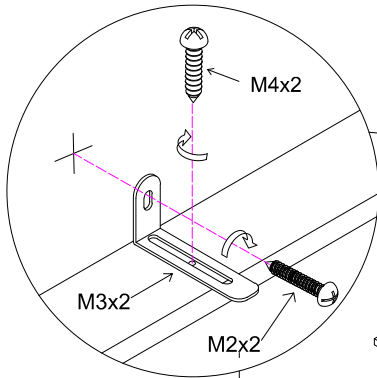
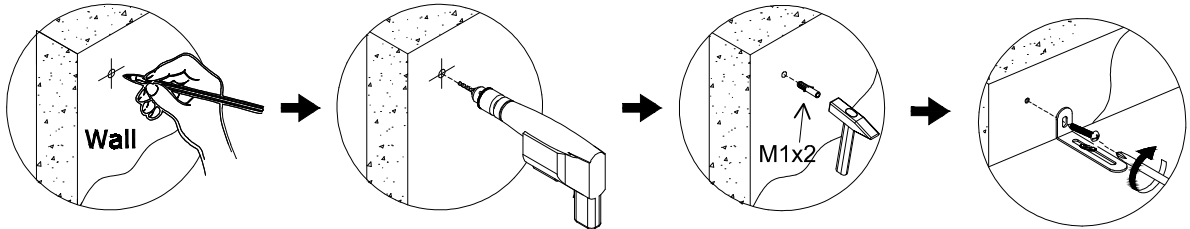

# 25

Attention: For safety and stability, we suggest you have to secure the anti-tip accessories to the wall to.

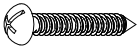



- (M1)   
M1x2
- (M2)   
M2x2
- (M3)   
M3x2
- (M4)   
M4x2

# 36

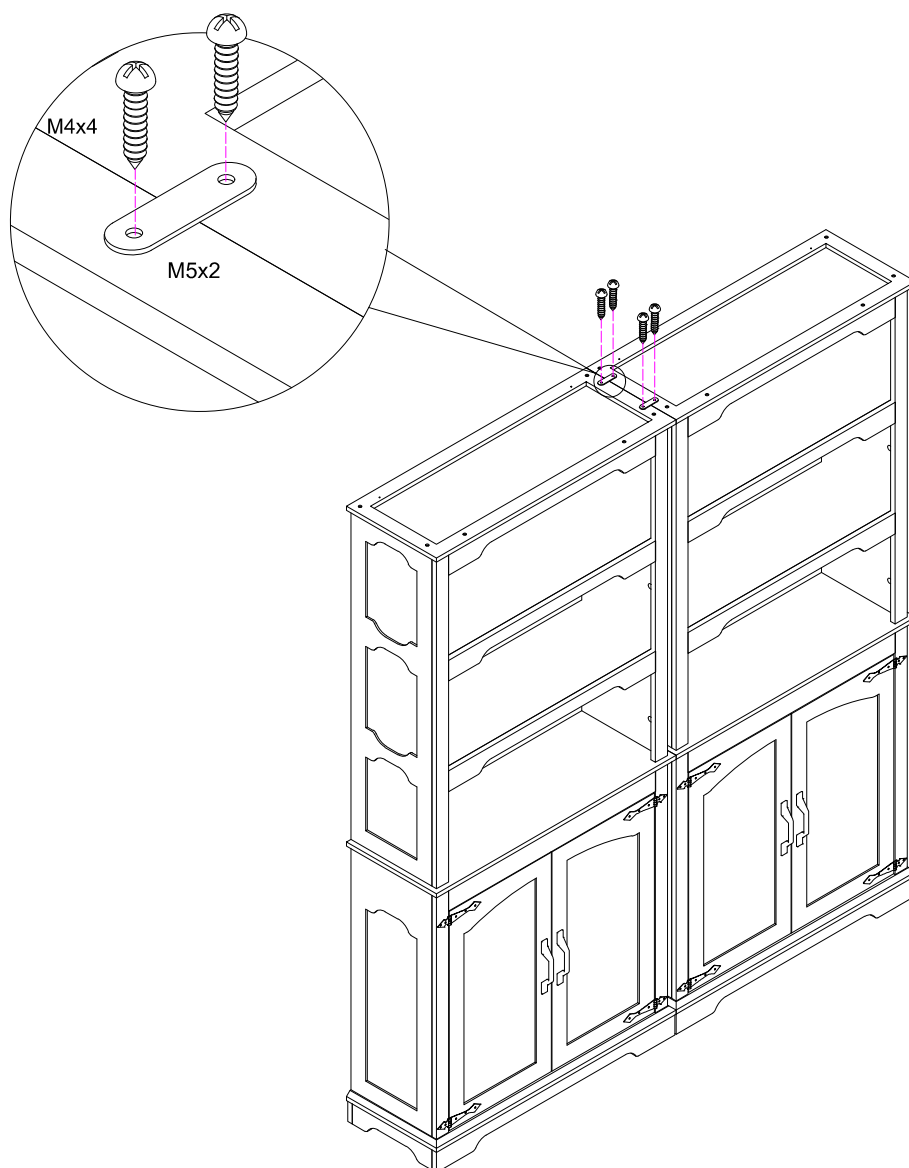
If you buy multiple bookcases and use them close together, you can choose to use the accessory M5 metal sheet to connect them closely, as shown in the figure below.



(M4) M4x4

M5x2