

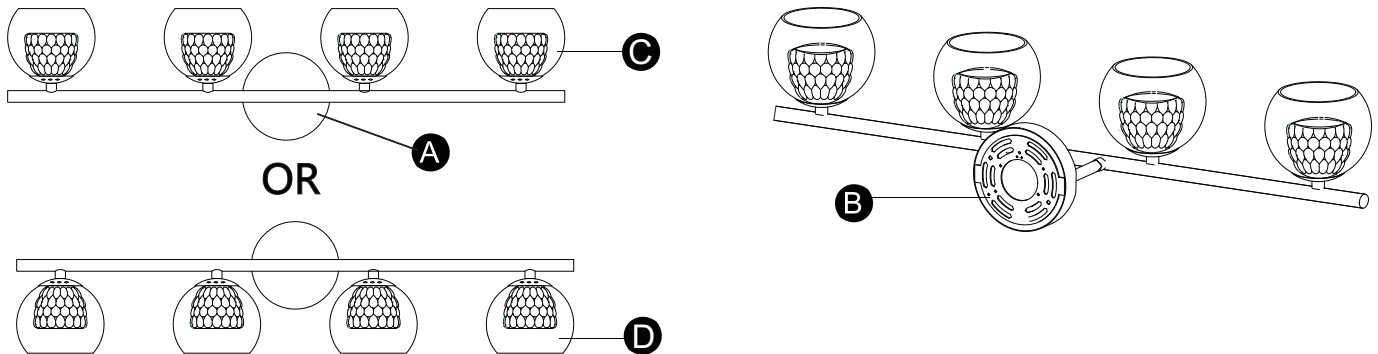







4 LIGHT VANITY LIGHT

PACKAGE CONTENTS

*This Fixture Can Be Installed Up or Down In Two Ways



HARDWARE CONTENTS Note: Hardware not shown actual size.

| | | | | | | | | |
|----|---|---------------------------|----|---|----------------------|----|---|---------------|
| AA |  | Wall Mounting Screw X2 | DD |  | Socket Ring X5 | GG |  | Tool X1 |
| BB |  | Wire Nut X3 | EE |  | Socket Ring X5 | HH |  | G9 Bulb X4 |
| CC |  | Grounding Screw X1 | FF |  | Mounting Screw X2 | | | |

SAFETY INFORMATION

Please read and understand this entire manual before attempting to assemble, operate or install the product.

WARNING

- Turn off electricity at main fuse box (or circuit breaker box) before beginning installation by removing fuse (or switching off circuit breaker).
- Be careful not to damage or cut the wire insulation (covering) during fixture installation. Do not permit wires to contact any surface having a sharp edge. To do so may damage or cut the wire insulation, which could cause serious injury or death from electric shock.

CAUTION

- All electrical connections must be in agreement with local codes, ordinances or the national electric code (NEC). Contact your municipal building department to learn about your local codes, permits and/or inspections.
- Risk of fire – most dwellings built before 1985 have supply wire rated for 140°F/60°C. Consult a qualified electrician before installation.
- Do not connect this fixture to an electrical system that does not provide a means for equipment grounding. Never use a fixture in a two-wire system that is not grounded. If you are not sure your lighting system has a grounding means, do not attempt to install this fixture. Contact a qualified, licensed electrician for information with regards to proper grounding methods as required by the local electrical code in your area.

PREPARATION

Before beginning assembly, installation or operation of product, make sure all parts are present. Compare parts with package contents list and diagram on previous page. If any part is missing or damaged, do not attempt to assemble, install or operate the product. Contact customer service for replacement parts.

Tools Required for Assembly (not included): Screwdriver, Phillips Screwdriver, Pliers, Electrical Tape, Wire Cutters, Safety Glasses, Ladder, Wire Stripper.

ASSEMBLY INSTRUCTIONS

Turn off the power at fuse or circuit box.

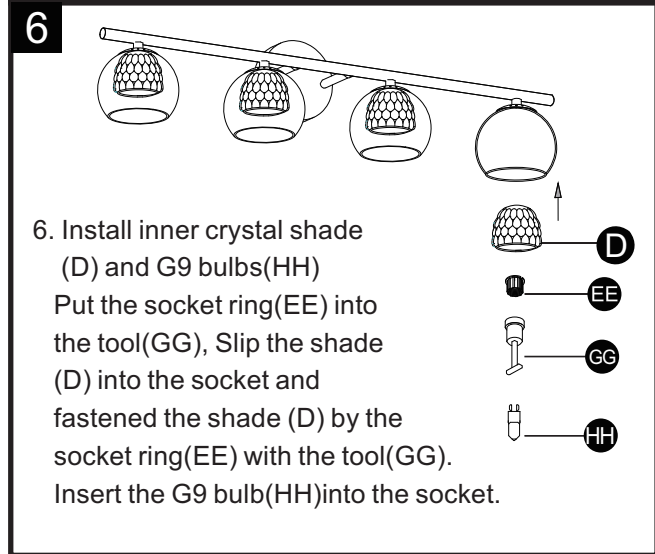
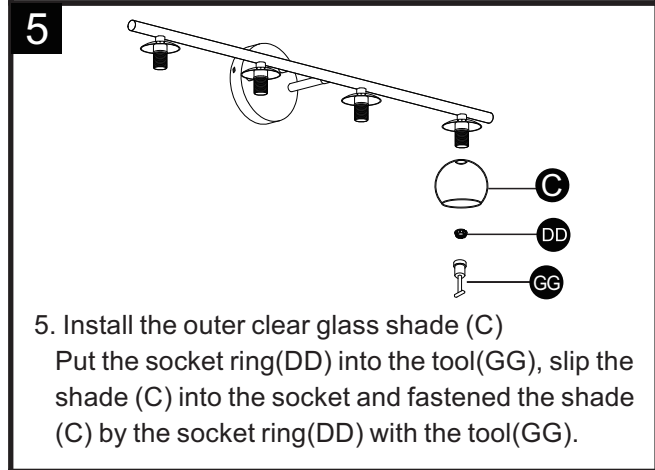
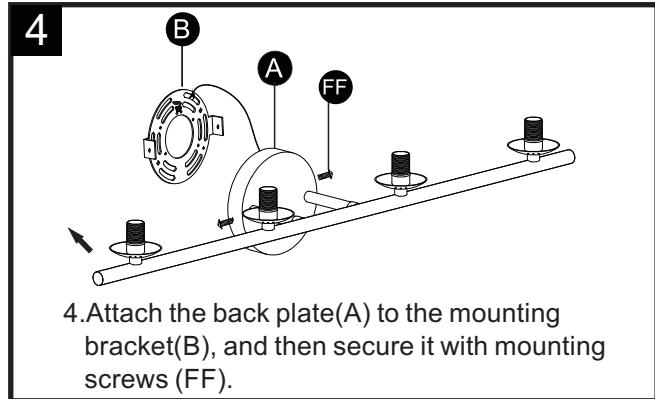
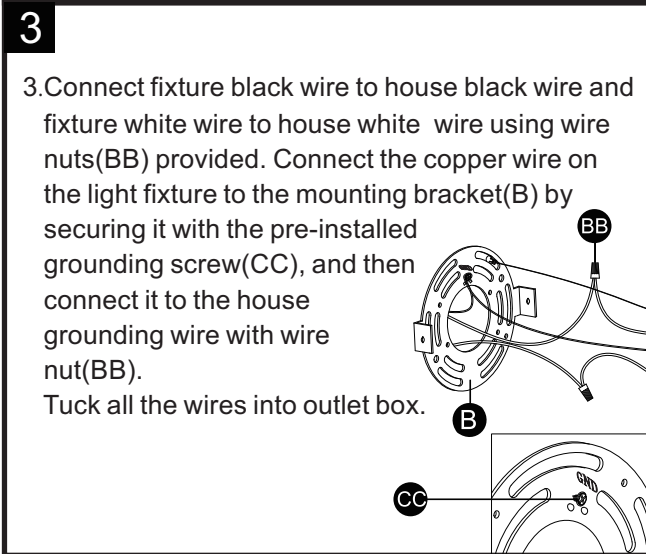
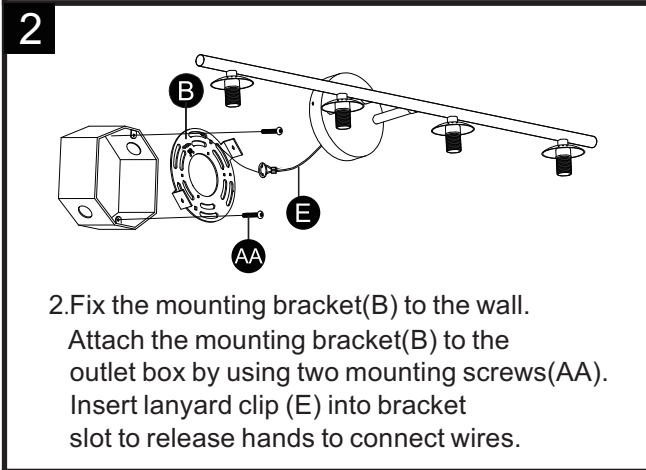
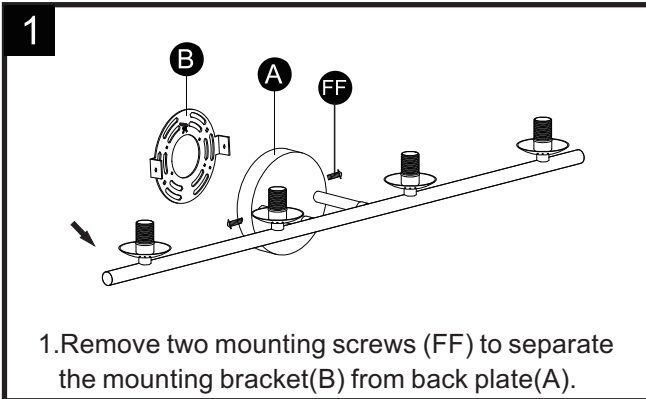

Turn on the power at fuse or circuit box.

CARE AND MAINTENANCE

- To clean, turn off and wipe with a damp, non-abrasive cloth.

TROUBLESHOOTING

- 1) **The light does not come on at all:**
 - a) Make sure the wall switch and circuit breaker are on.
 - b) Make sure the wiring is correct.
- 2) **Fuse blows or circuit trips when light is turned on.**
 - a) Check for crossed wires, ensure wiring is correct.

If unable to fix any of the above issues, please consult a certified electrician.