

INSTALLATION MANUAL

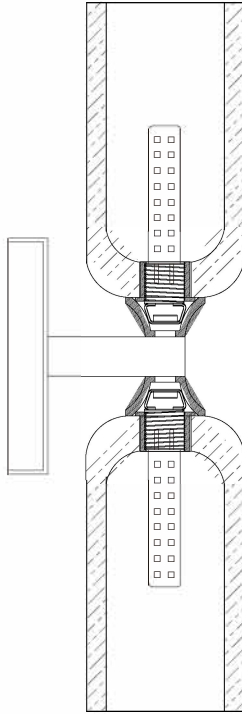









This manual only shows the installation steps for one size, and the installation methods for other sizes of products are similar.

Now, let's complete this light together.
Be patient.....

and fully utilize your artistic talent

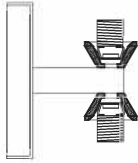
What awaits you after completion is incredible beauty!

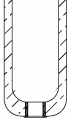
accessories list

<p>A* 4</p> 	<p>B* 1</p> 	<p>C* 4</p> 	<p>D* 3</p> 
<p>E* 1</p> 	<p>F* 2</p> 	<p>G* 2</p> 	<p>H* 2</p> 
<p>I* 1</p>	<p>J* 1</p>	<p>K* 0</p>	<p>L* 0</p>
<p>M* 0</p>	<p>N* 0</p>	<p>O* 0</p>	<p>P* 0</p>
<p>Q* 0</p>	<p>R* 0</p>	<p>S* 0</p>	<p>T* 0</p>

STEP I Unpacking

Open the box, and take out all the accessories, you will get the following items.

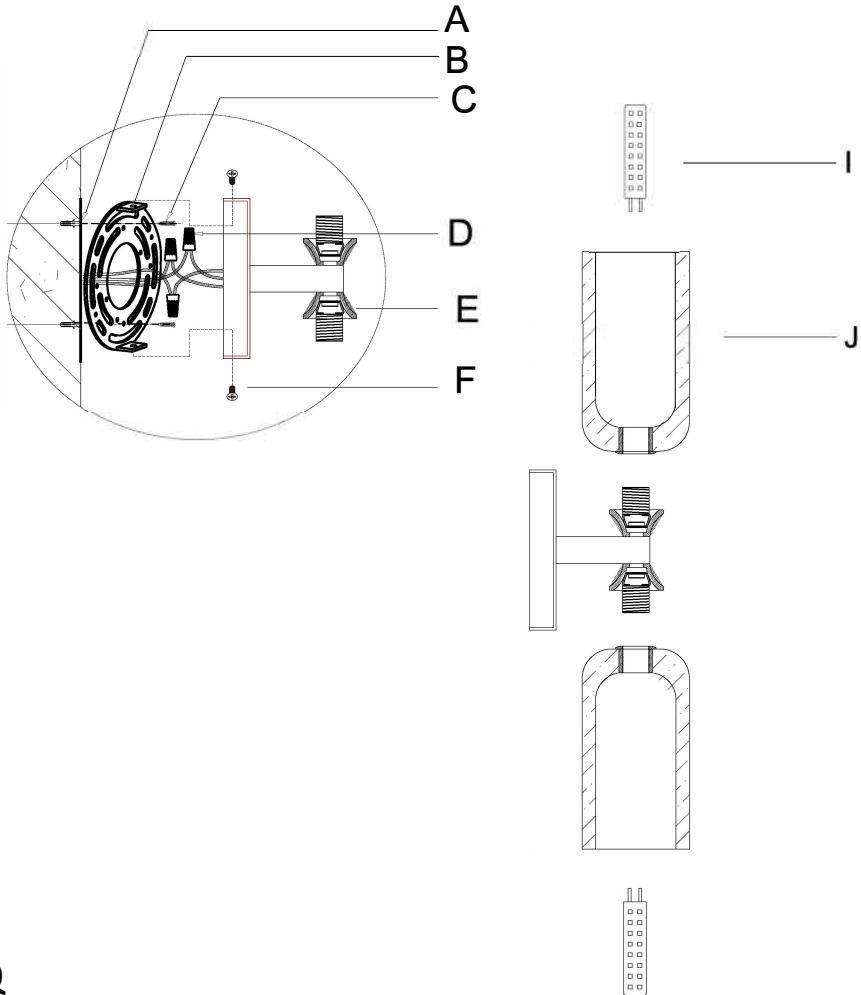

FAQ

Q:After opening the box, I found that the Spanish Marble accessory is broken?

A: Since the Spanish marble lampshade fittings are made from natural rock, they are inherently fragile, so We have taken this situation into consideration. The box has been reinforced.If there is still breakage ,contact us in time,we will send you a new Spanish marble accessory.

STEP II Branch Adjustment

Connect lamp wires and your house wires together.
Install the lamp frame on ceiling.

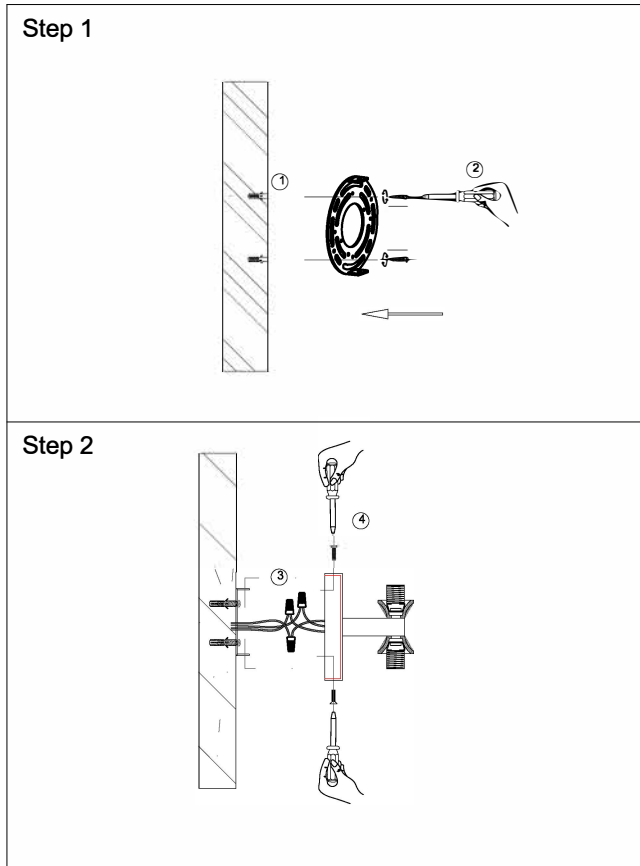

FAQ

Q: How do I differentiate between Neutral wire, Live wire and Ground wire?

A: We have distinguished markings between the N and L wires and the brass wire on the mounting bracket is the ground wire.

STEP III Wiring and Mounting

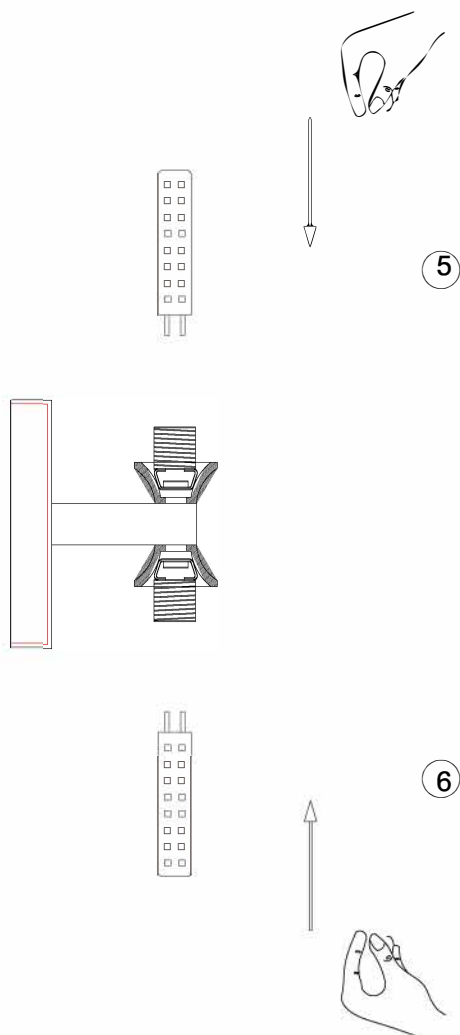

FAQ

Q: What if the bulb is not vertical when installing?

A: We can loosen the bulb to fine-tune the angle. Ensure the light bulb is vertical when being locked! So that the light bulb will not touch the inner wall of the lampshade!

STEP IV Mounting Sconce

Step 4

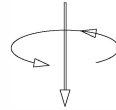
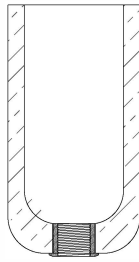

7

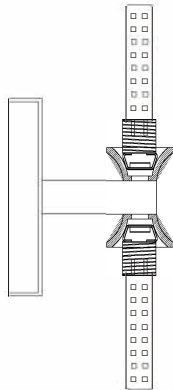

8

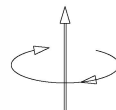
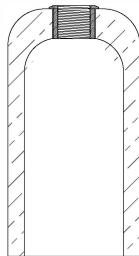

FAQ

Q:What do I need to pay attention to when I install a Spanish marble light shade?

A:Since Spanish marble is fragile, we simply place the Spanish marble gently on the matching lamp body to prevent them from falling off.

Please note:

Please check the parts list firstly, if there are any parts missing during your actual installation, contact us immediately, we will help you in time!

No matter what problems or questions you encounter during the installation or use of the wall sconce, please feel free to contact us, we will reply to you within 24 hours and quickly solve or answer for you!

When you leave a message to us online, please leave your order ID and case details. The more detailed and accurate descriptions you provide, the faster and more accurate solutions we will offer!



SAFETY INSTRUCTIONS

These instructions are provided for your safety. It is very important that you read the instructions completely before starting the installation of your fixture.

1. We recommend installation by a licensed electrician.
2. This fixture requires G9 bulbs (INCLUDED) and bulb rated wattage: Max 10W. Low wattage LED bulbs are recommended. To avoid risk of fire, do not exceed the recommended wattage.
3. If any special control devices are used with this fixture, follow the instructions carefully to assure full compliance with N.E.C. requirements. If there are any problems, contact a qualified electrical contractor.
4. Please ensure that you shut off the main electrical supply before installation, changing bulbs or cleaning light fixture.



WARNINGS

This is not a toy and the product has no play value.
Keep at least 3 ft away from cribs, bassinets, and toddler beds.
Keep out of reach of children under 3 years old.



PREPARATION

1. Please prepare the G9 bulbs in the package in advance.
2. Please keep the installation place clean and tidy to avoid missing tiny accessories.