

# Assembly Instructions

Caution : You must read this before you proceed

## Power Recliner

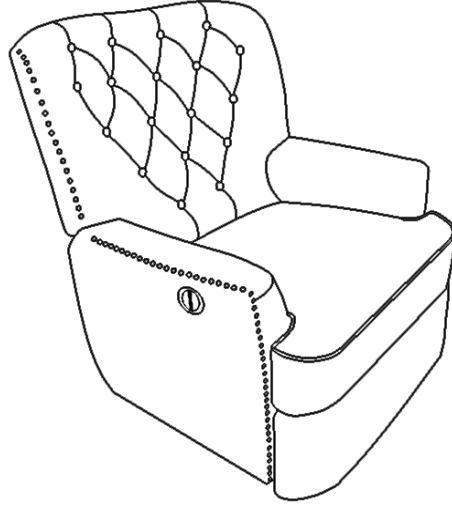

Motor Repair Service Contact: Aode +1 662 523 5120

### Parts List

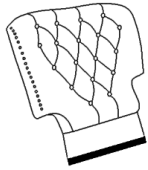
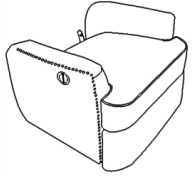
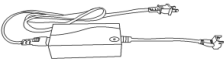
Label	Picture	Description	QTY (pc)
A		Chair Backrest	1
B		Chair Base With Footrest	1
C		Power Cord with transformer	1

## Assembly Preparation

Before Beginning Assembly:

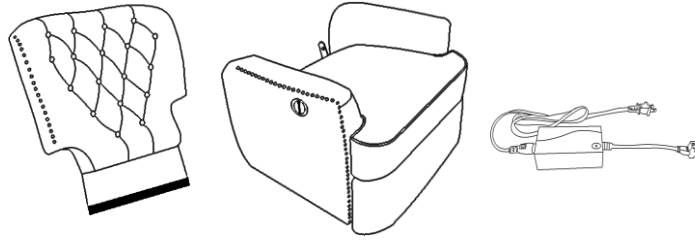

- Have 2 adults on hand for assembly-



- Do not assemble on flooring or carpet-



- Assemble on a clean non-marring surface (packing foam)-



- Save all packaging until finished-

## Assembly Steps

Parts Introduction

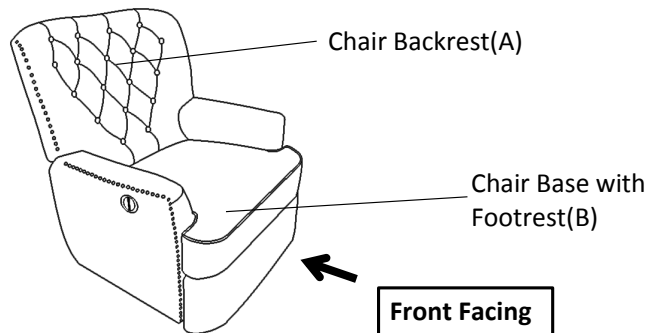

This product has multiple parts and may require up to some 30 minutes to assemble. To give you an overview of the product parts, the above picture is to help you put the various parts into perspective. Please read through the instructions below to familiarise yourself with the parts and steps before assembly.

**Step 1**

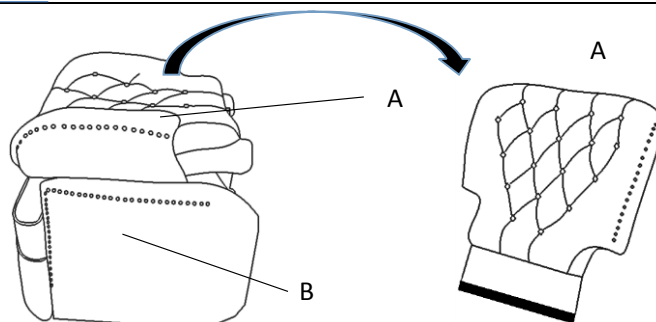

Take out the Chair Backrest(A) from the Chair Base with Footrest(B).

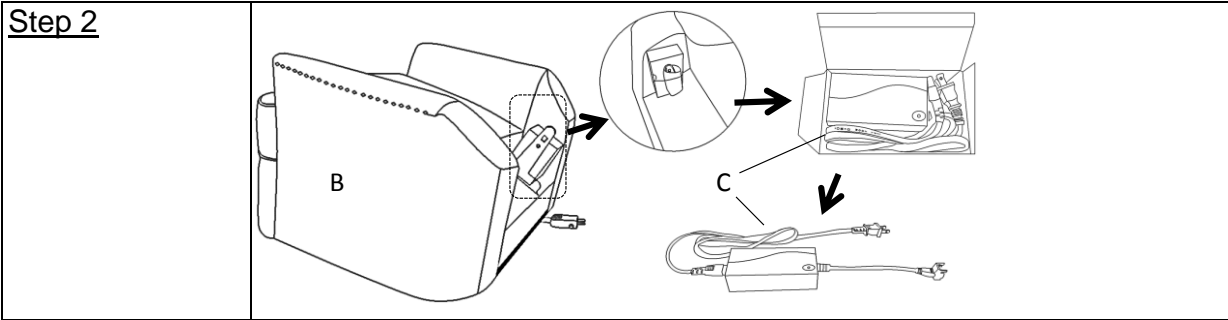

Take out the small carton box and open it to take out the Power Cord with transformer (C).

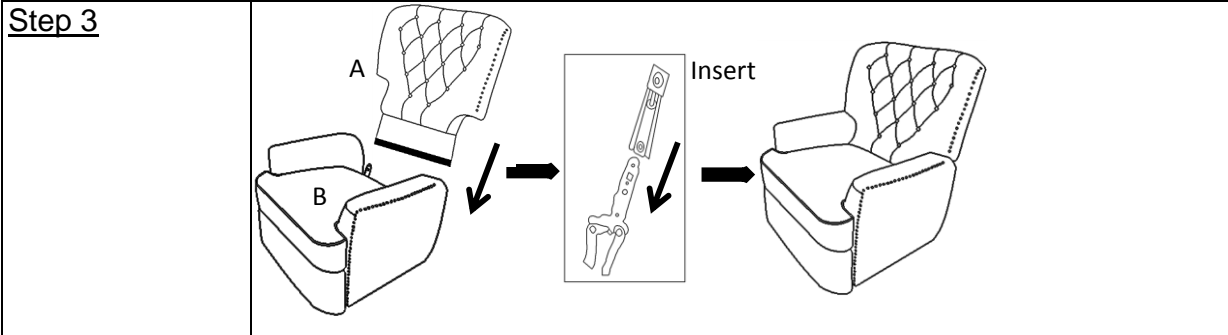

With assistance from your adult partner, hold up the fully assembled Chair Backrest(A), standing behind the Recliner Chair. Insert the small metal arms on the sides of the Chair Backrest(A) into the prefabricated slide lock gadget on the Chair Base with Footrest(B) as shown above. Firmly but gently, push the Chair Backrest(A) downwards until the Backrest(A) is fully slotted and locked into position.

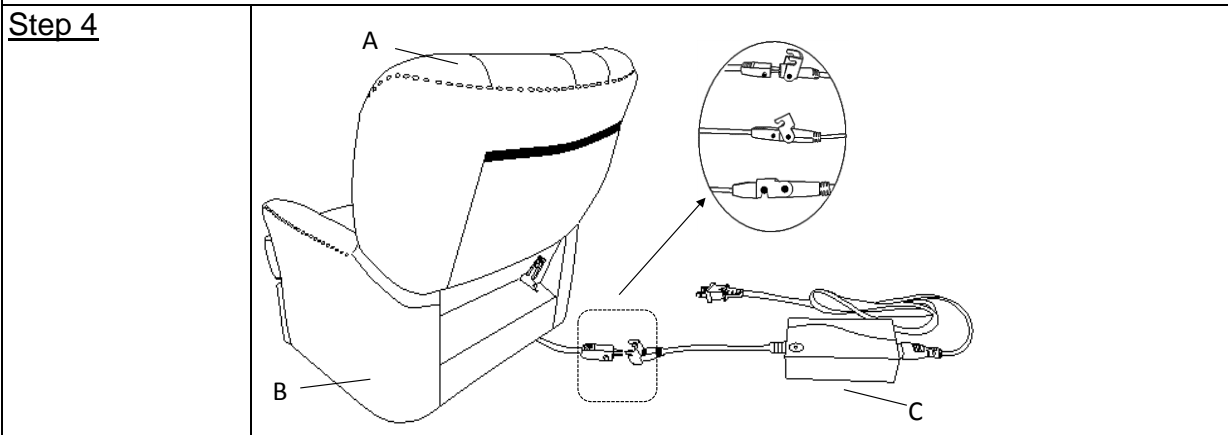

Go to find the motor connector under the bottom of the seat. Connect the joint from the motor and the Power Cord(C) , fix the draw-ingear after connected.

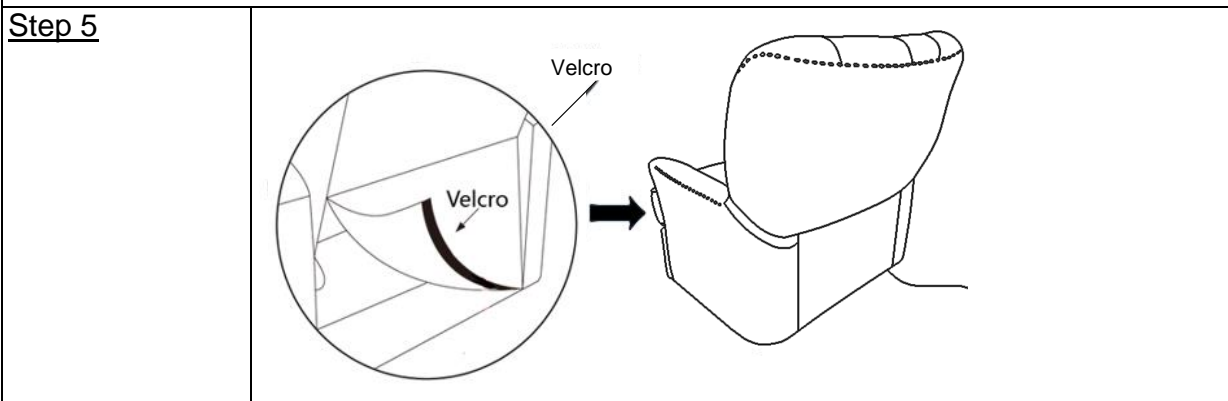

Smooth down the fabric flap on the Chair Backrest(A). Run your hands down both sides of the flap, from top to bottom, allowing the velcro tape to adhere to the flap under the seat of the Chair.

**Step 6**

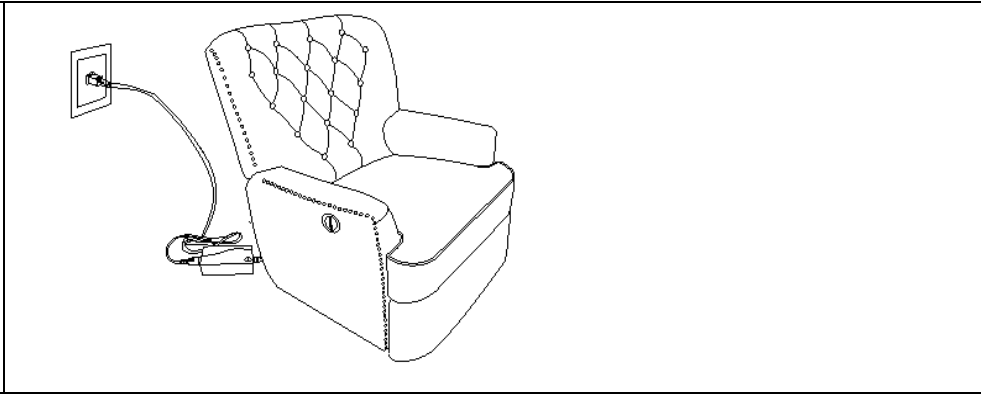

Make sure all parts are connected and securely locked into position. Plug into a socket into position on the wall or any other place. Now your Recliner Chair is ready for use.

**Step 7**

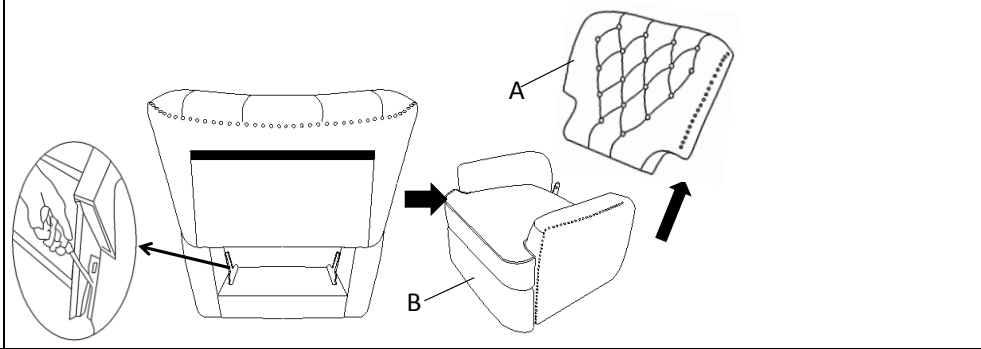

Disassembly Note:open the flap on the Chair Backrest(A),use a screwdriver(Don't use fingers) pressing outward on the metal ear on the preattached Metal Bracket on one side of the Chair Base(B),with assistance of you adult partner to keep the Chair Base(B) in place,pull out the Chair Backrest(A) upward at the same time,repeat the same step for another side.Then the Chair Backrest(A) can be taken out.

**Step 8**

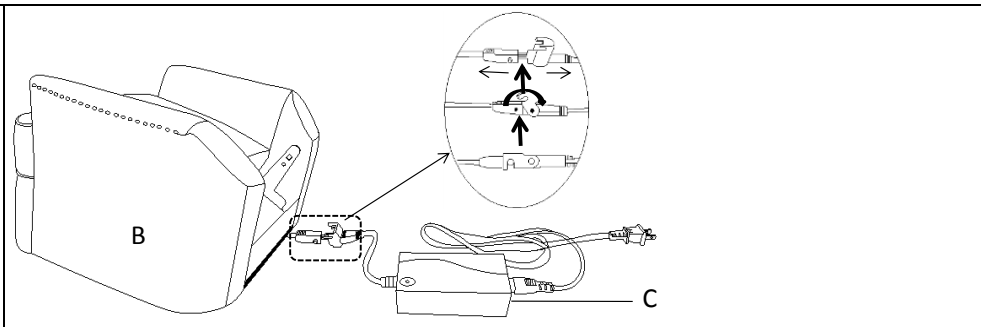

Force apart the draw-ingear , then separate the joint from the motor and Power Cord(C).

## User Instructions.

### Push Back Chair

Please read the Instruction Manual below carefully before use.

Supervise children,when in use of this Power Recliner.

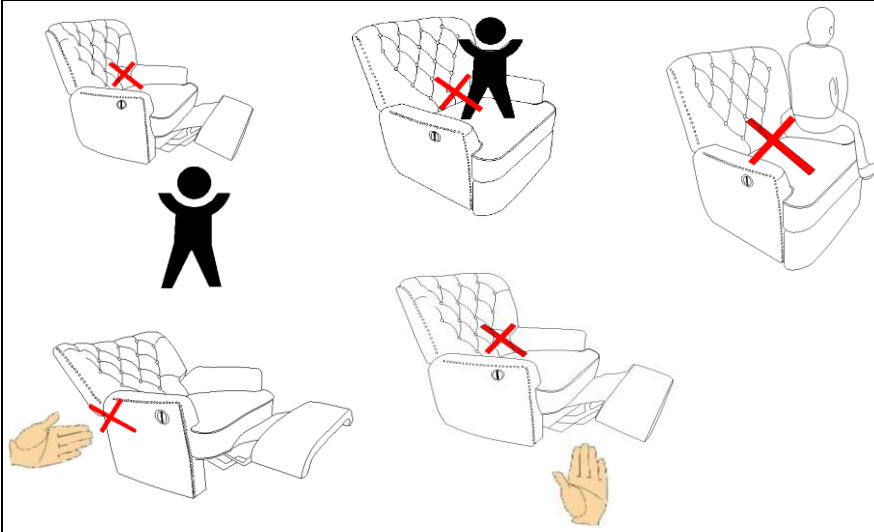

Do not allow children to play on the chair.  
Always leave the chair in an upright and closed position after use.  
Keep hands and feet clear of the footrest mechanism and any gaps.  
Just open it or close it with the button of switch  
Don't sit any armrest of chair.

To get into a open position-To press the front button of switch.

Sit into the seat.

The Chair Backrest will fall down and footrest will open when press the front button of switch,the Chair Backrest by your back.So do must put your feet on footrest well when you press the front button of switch on the outside of right armrest until into a fully reclined position.

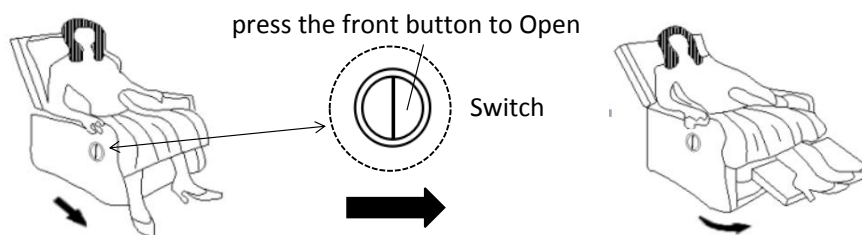





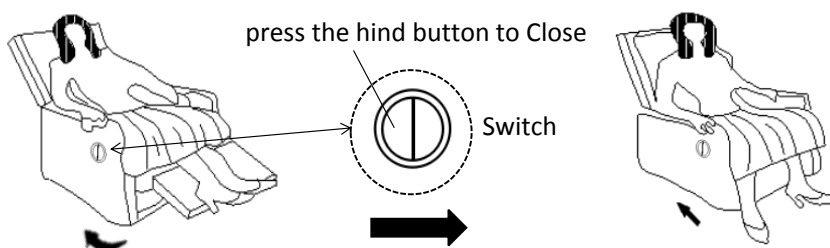















To get out of chair-move Seatback into Upright Position:To press the front button of switch.

Tilt your body weight slightly forward and upwards.  
The seat back will come up to an upright position.  
Use your finger to press the hind button of switch on the outside of right armrest.  
The Recliner Chair will close smoothly until into a fully upright position.



## Care & Maintenance

-   ● Do not put hot items directly on furniture surface
  -   ● Do not clean furniture with harsh cleansers or polish.
  -   ● Do not place furniture under direct sunlight.
  -   ● Do not place furniture near heating or cooling vents.
  -   ● Do not write on furniture without a padded barrier to protect the surface.
  -   ● Do not place furniture outside . For indoor use only .
  -   ● Not for commercial use. For residential use only .
  -   ● Stains may be removed with mild soap solution and damp cloth.
  -   ● Children should not climb or jump on the furniture.
- 
-   ● Dust and pick-up spills using a clean, non-colored, lint-free cloth .

### What is Proposition 65?

Proposition 65 is a California law that requires warning labels on products that may contain one of more than 800-plus chemicals or ingredients that the California Office of Environmental Health Hazard Assessment (OEHHA) has deemed to cause cancer or other reproductive toxicity. Chemicals and elements on this list include wood dust, brass, and other everyday substances, which can be found in very common household items, such as: lamps, tableware, jewelry, crystal glasses, electric cords, beauty products, automobiles, and furniture.

### Why Did I Find a Proposition 65 Warning on My Home Goods Product?

We include Proposition 65 warnings on all of our products because there is always a chance that one of the 800-plus common chemicals and ingredients listed under this law could potentially be on our furniture or packing materials. We risk large fines under this law, if we don't include this warning.

### Should I worry?

We realize you may be worried finding this warning on our products, but we want to reassure you that the hazardous exposure limits for any of these chemicals have never been found on furniture products that we've shipped to our customers. Additionally, this warning label is very common and can be found on almost every piece of furniture sold in the state of California.

### Just How Common Are Proposition 65 Warnings?

Proposition 65 warnings have become so common in California that it is hard to take a trip to a local bank, grocery store, or restaurant without finding at least one warning. In fact, even the Disney Land Resort has a Proposition 65 warning:

