

ASSEMBLY INSTRUCTIONS

Friendly Reminder

- 1.This sofa is packed in two boxes, please ensure both boxes have arrived before beginning assembly.
- 2.Before starting, review the instructions carefully and confirm that all parts are included.
- 3.Keep the vacuum-sealed cushions unopened until the sofa frame is fully assembled.
- 4.Due to vacuum packing, cushions may have wrinkles. To help them regain their original shape, give each cushion a few firm slaps and allow up to 72 hours for any wrinkles to disappear.

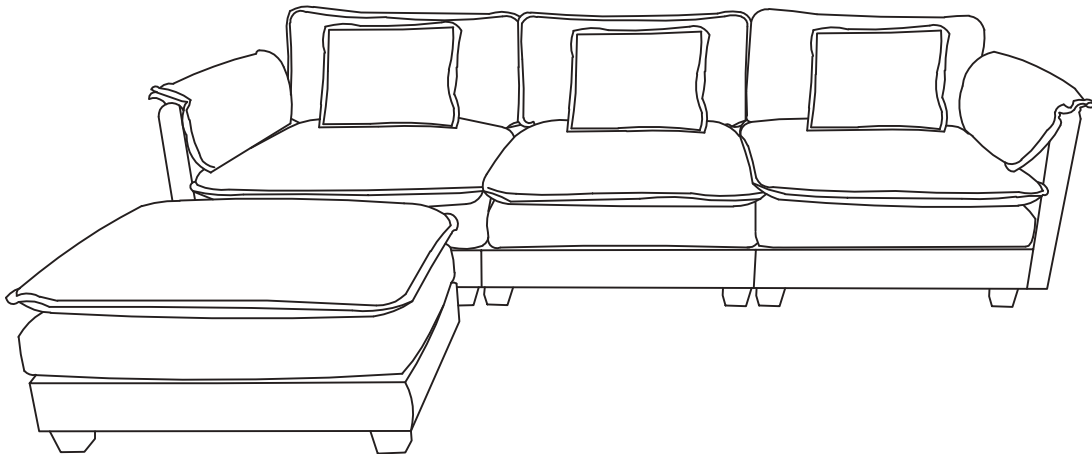







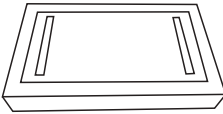

Return & Warranty Policy

- 1.We are dedicated to delivering high-quality products and exceptional service to ensure your satisfaction. If you need replacements or assistance, please don't hesitate to reach out to us.
- 2.If your item arrives damaged or defective, kindly take multiple photos as evidence to support replacement or refund requests.
- 3.Please do not return the item to the store. For any issues with this product, contact the seller directly for support.

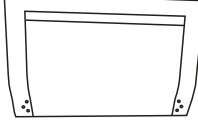

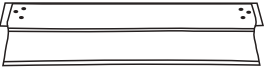



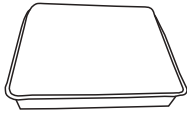

ASSEMBLY INSTRUCTION

BOX A PART LIST

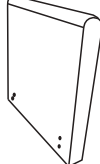





NO	DESCRIPTION	SKETCH	QTY
A	Left iron frame		3
B	Right iron frame		3
C	Ottoman frame		1
D	Ottoman cushion		1
E	Back frame		3
F	Back cushion		3
G	Seat board		3
N	Wooden Slats		6

ASSEMBLY INSTRUCTION

BOX B PART LIST







NO	DESCRIPTION	SKETCH	QTY
H	Seat cushion		3
I	Left armrest		1
J	Right armrest		1
K	Left armrest pillow		1
L	Right armrest pillow		1
M	Pillow		3
N	Wooden Slats		9
O	Leg		16

ASSEMBLY INSTRUCTION

NO	DESCRIPTION	SKETCH	QTY
1	Gasket		16
2	Washer		52
3	Screws M8X20mm		18
4	Screws M8X35mm		26
5	Screws M8X60mm		4
6	Butterfly nut		4
7	Wrench		1



ASSEMBLY INSTRUCTION

All parts and hardwares.

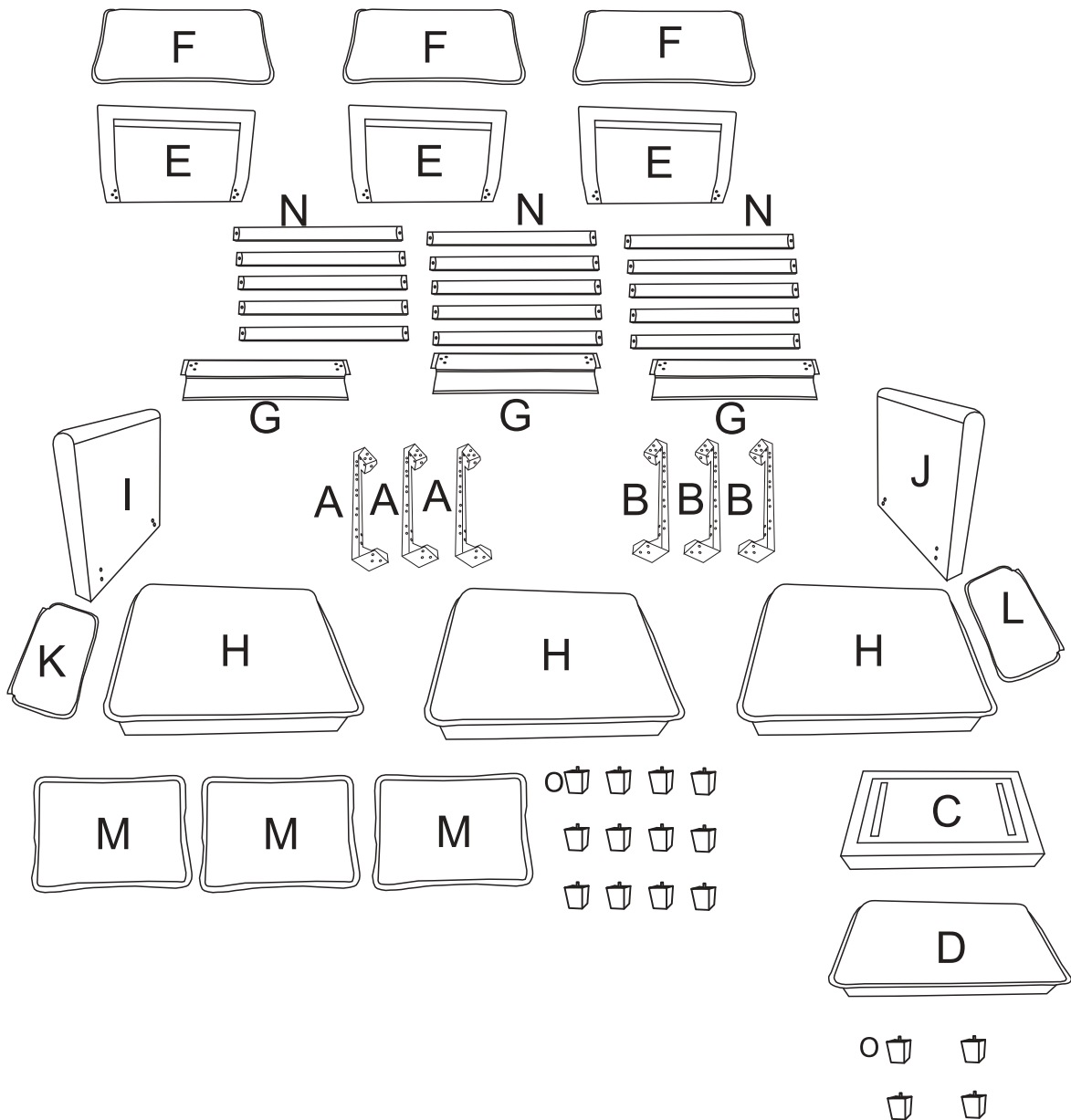
1	Gasket		16
2	Washer		52
3	Screws M8X20mm		18
4	Screws M8X35mm		26
5	Screws M8X60mm		4
6	Butterfly nut		4
7	Wrench		1



Step 1: Assemble the Sofa Frame



2		18PCS
3	 M8X20mm	18PCS

① Place parts A, G, and B on the floor, ensuring parts A and B are positioned in the correct direction. Secure the parts together using the screws #3 and washers #2.

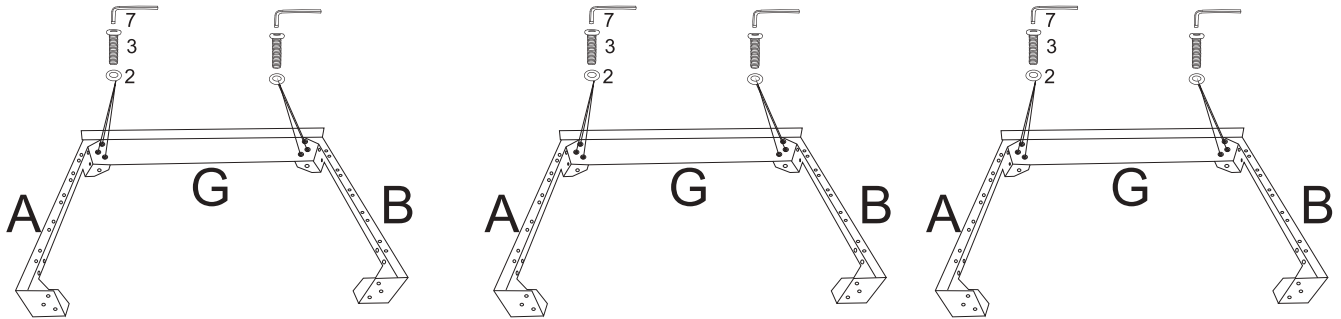
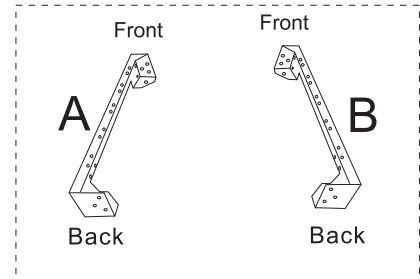
② Tighten the screws to 50% in this step.



Step 2: Assemble the Sofa Backrest

2		18PCS
4	 M8X35mm	18PCS

① Lift the cover cloth, then attach the backrest by inserting the screws from the back. Secure using the screws #4 and washers #2.

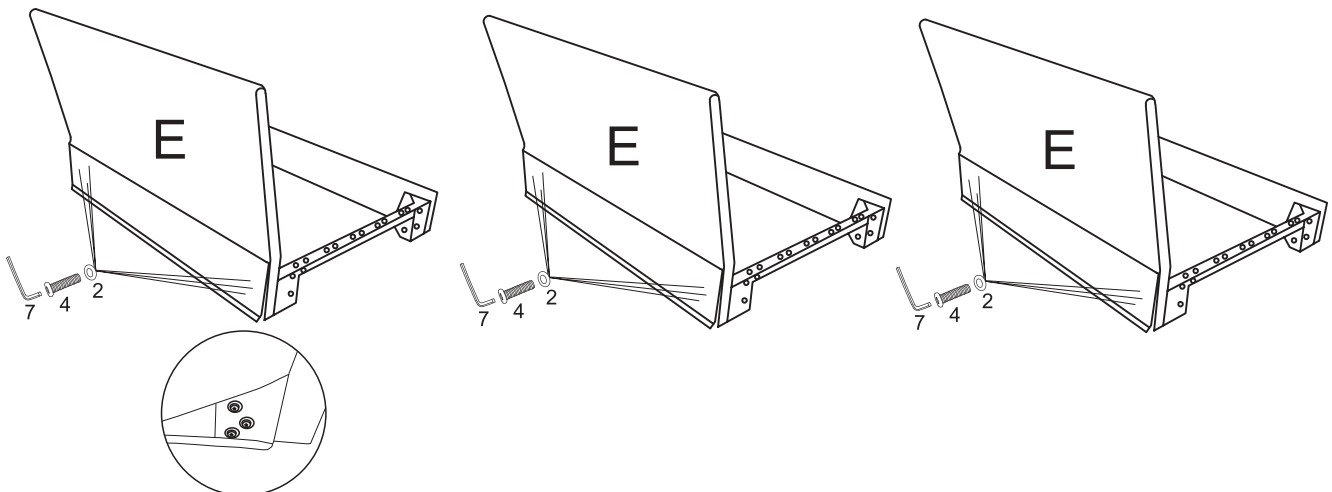

② Tighten the screws to 50% in this step.



Step 3: Assemble the Armrests

① Align the screw holes on the armrests and secure them by installing the screws #4, #5 and washers #2.

② Tighten the screws to 50% in this step.

2		8PCS
5	 M8X60mm	4PCS
4	 M8X35mm	4PCS

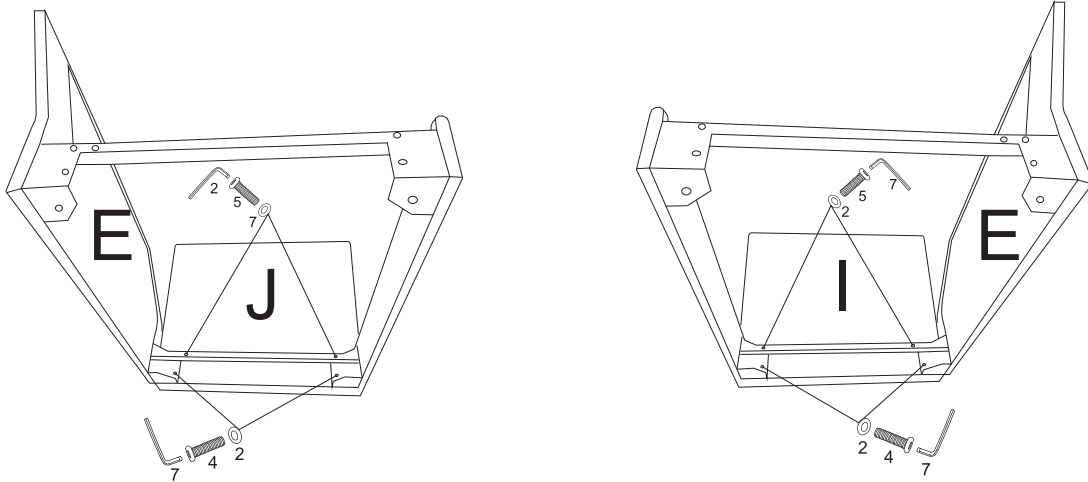

Step 4: Assemble the wooden slats.

Arrange the slats in order and press them into the corresponding holes.

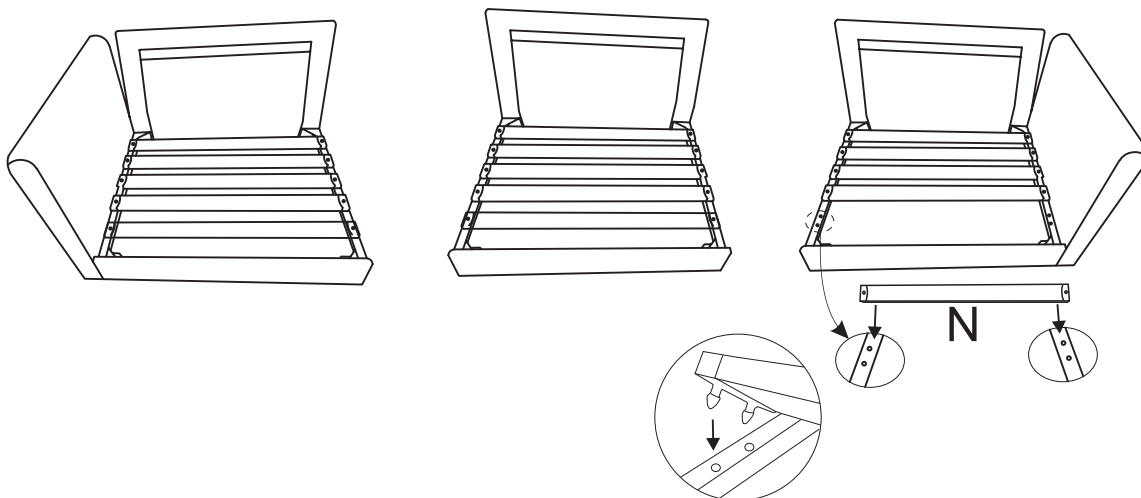

N		15PCS
---	---	-------



Press into the hole

Step 5: Connect the frames of the sofa

Place the sofa frame on its side, use the screws #4, washers #2 and nuts #6 to attach the seat frames together securely.

2		8PCS
6		4PCS
4	 M8X35mm	4PCS

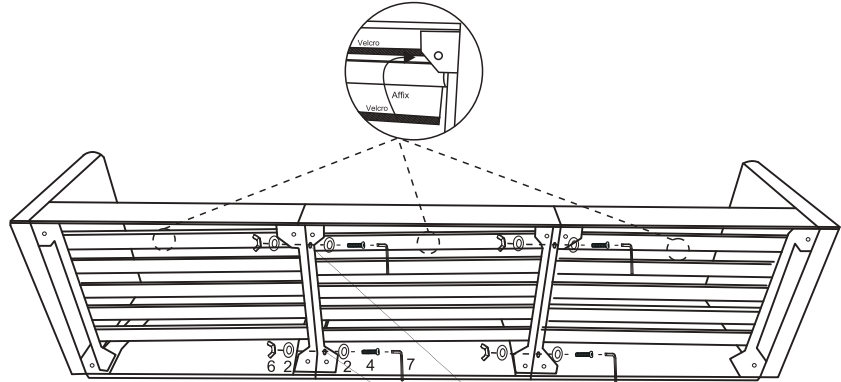

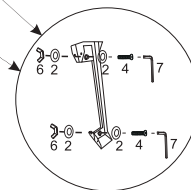

Attention:

Tighten all screws to 100% in this step.



Step 6: Assemble the legs of the sofa and the ottoman

Install the legs to the frames along with the gaskets

O		16PCS
1		16PCS

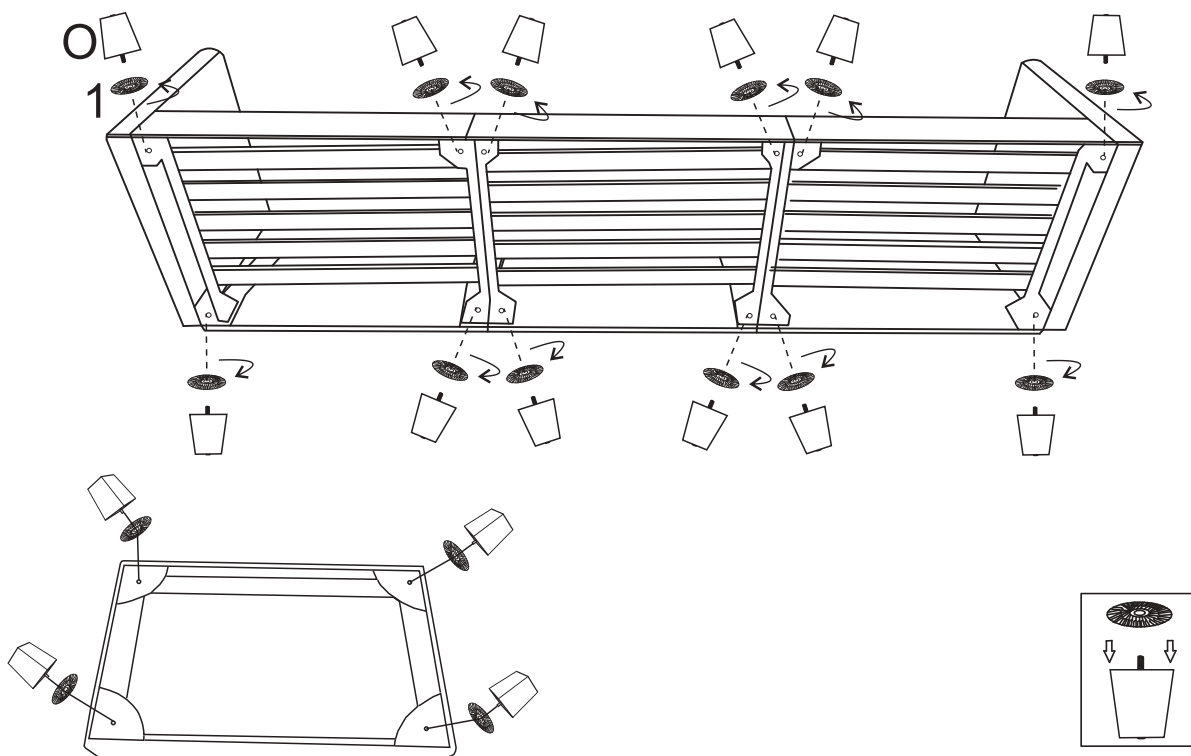

Step 7: Recover the vacuum-sealed cushions

Carefully cut and open the vacuum-sealed bags, pull the cushions out of the bags, and gently pat them to evenly fluff, shake or roll them to help restore their original shape.

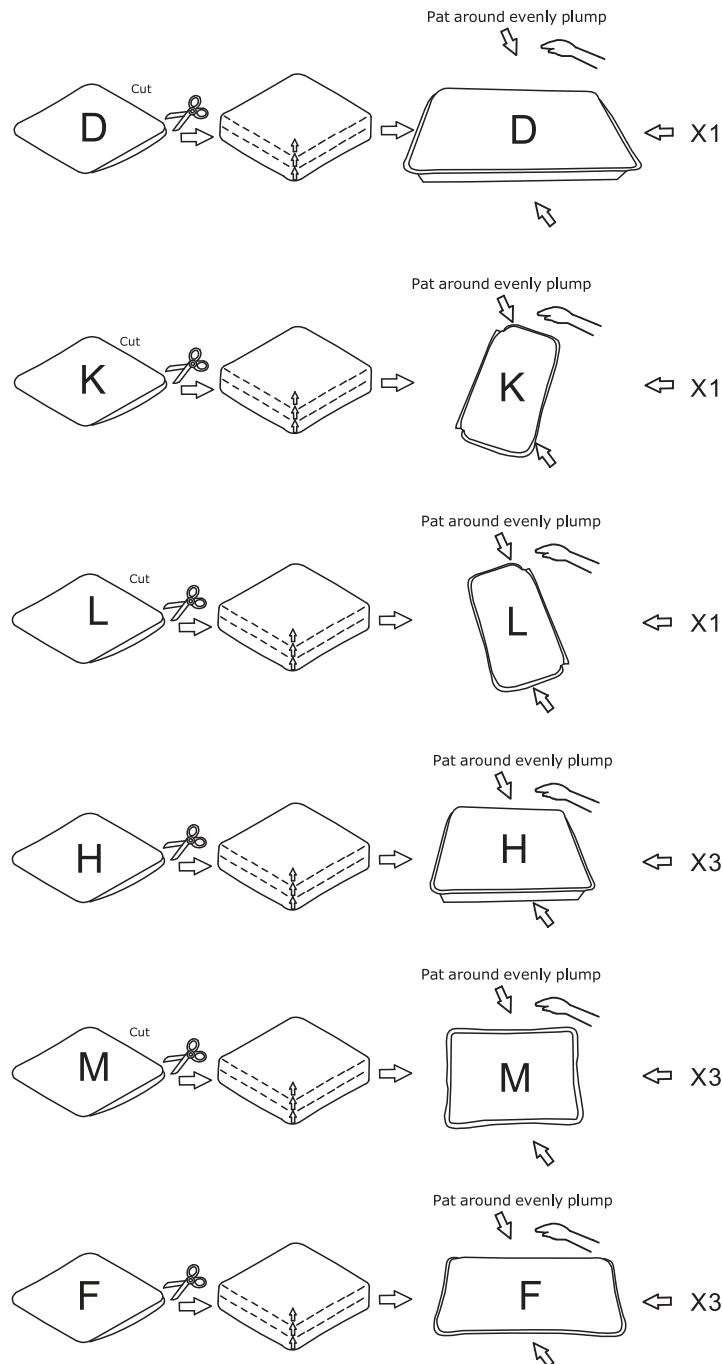

Tips for Assembly and Safety:

1. Assemble the Frame First: Do not open the compressed packages until the sofa frame is fully assembled.
2. Allow Cushions to Expand: Compressed back cushions and pillows need up to 72 hours to fully expand for optimal comfort.
3. Keep Children Safe: Keep children away from plastic bags or small parts to avoid potential hazards.

Step 8: Assemble the cushions

Place the pillows and cushions referring to the instructions

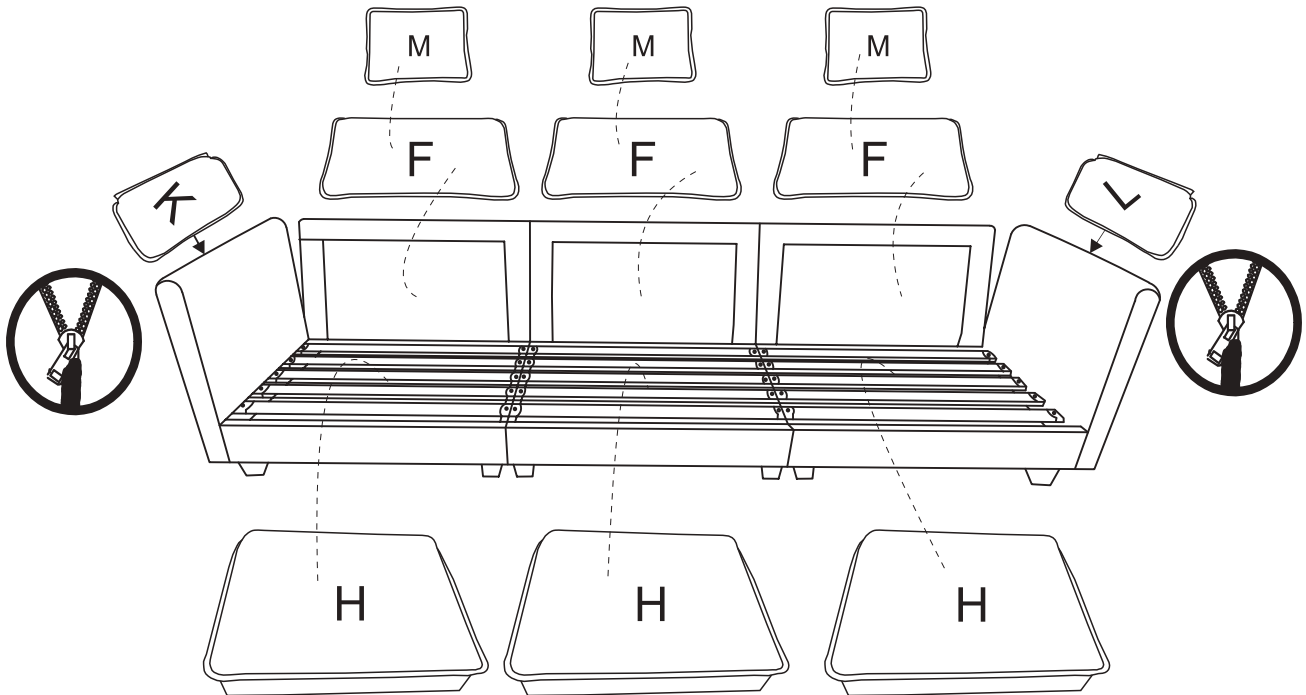

Step 9: Assemble the ottoman

Place the ottoman cushion on the ottoman base

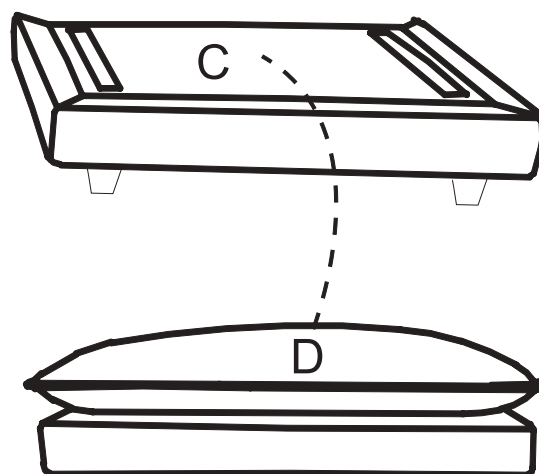

COMPLETE
Enjoy it!

