

Assembly Instructions



Assembly Instructions

INSTALLATION GUIDE

ONE PERSON ASSEMBLY: 15 MINUTES (APPROXIMATE)
TOOLS REQUIRED: ALLEN WRENCH (PROVIDED)

BEFORE ASSEMBLY

1. Remove all packaging materials, staples and packing straps from the carton.
2. Confirm with Parts Checklist in Page 3.

ATTENTION

1. Leave sufficient room for assembly.
2. Do not assemble on the ground that may hurt the product.
3. Do not over-tighten any fittings as it may cause damage.
4. **DO NOT USE POWER TOOLS TO ASSEMBLE THIS PRODUCT.**
5. Do not sit or stand on it before the assembly is complete.

DAILY MAINTENANCE

1. Recommended for indoor use only.
2. Wipe with a soft, dry cloth. Keep away from abrasives and household cleaners.
3. Check all the fittings periodically and re-tighten if necessary. Do not use the product if any part is damaged or broken.

Office Desk Chair Warranty Policy

The office desk chairs are warranted from the date of purchase due to material and workmanship factors. Details as follows:

1 YEAR on all unmovable metal parts;

1 YEAR on upholstered PU leather and foam;

1 YEAR on component parts including control mechanism, gas cylinder, wood, plastic parts, base and casters.

To make a warranty claim, please contact us with model number, purchase proof, problem descriptions as well as pictures that shows the problem clearly.

Problem verified, we will:







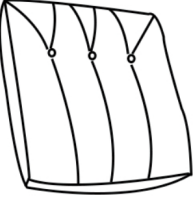

a) Send replacement parts.

b) Send a new product if necessary, customer need to return the original item to our warehouse. Return freight will be undertaken by us.

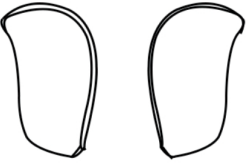
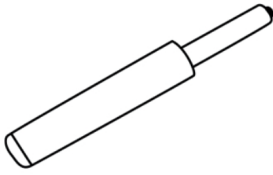
RETURN POLICY

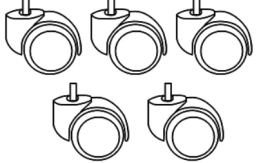
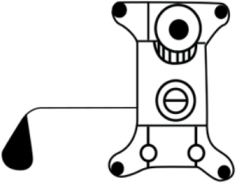
30 Days Free Return Policy after receiving the product is available. We offer prepaid return labels and undertake the return freight.

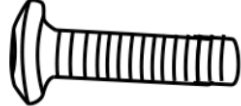
PARTS CHECK LIST

 <p>Ax1</p>	 <p>Bx1</p>	 <p>Cx2</p>	 <p>Dx1</p>	 <p>Ex1</p>
 <p>Fx1</p>	 <p>Gx5</p>	 <p>Hx1</p>	 <p>Ix4(6*20mm)</p>	 <p>Jx10(6*25mm)</p>  <p>Kx14</p>

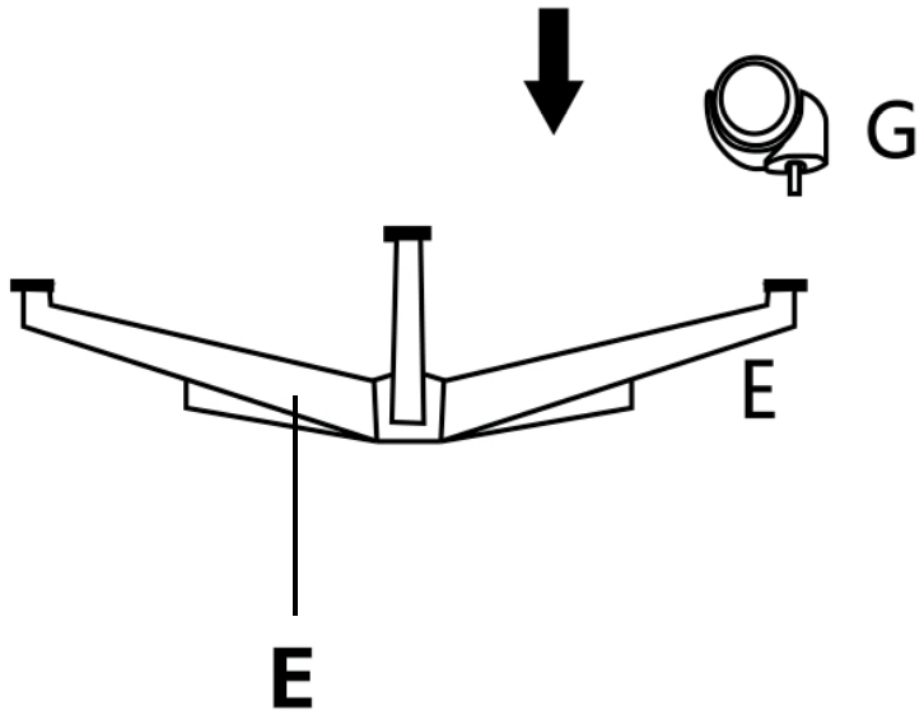

Step 1: Insert the casters **G** into the five star base **E** with force.

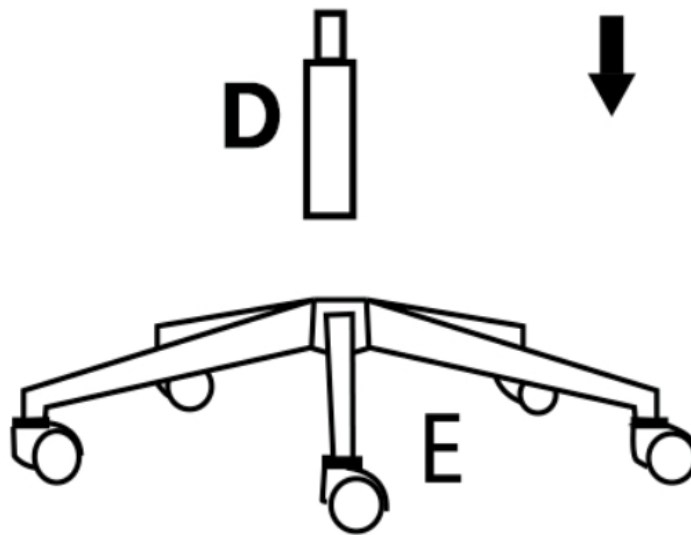

Step 2: Insert the gas lift **D** into the center of the base.
Remove the small black gas lift cover before taking the next step.

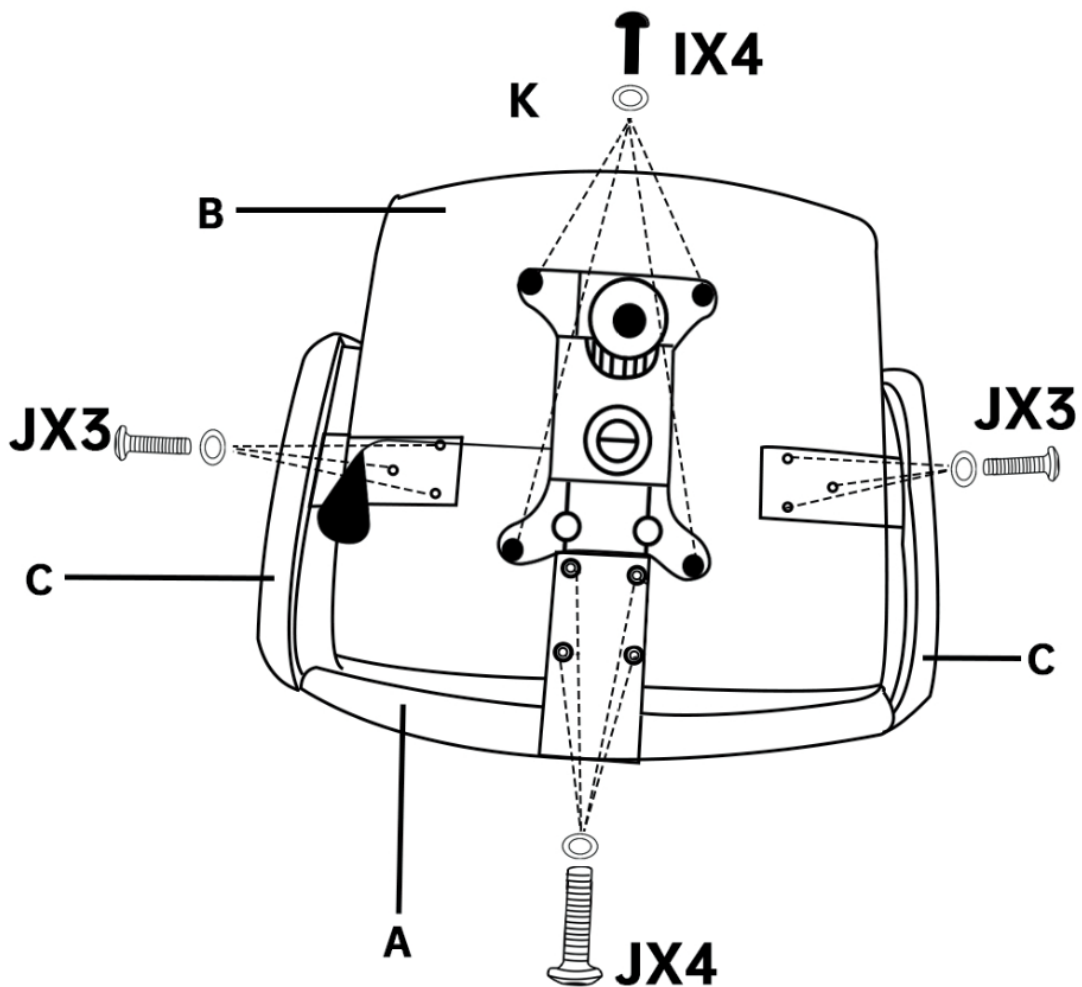

Step 3: Attach the back **A** to the Seat **B** with Screws **Jx4**.
 Attach the tilt mechanism **H** to the Seat **B** with Screws **Ix4**.
 Attach the 2 armrests **Cx2** to the Seat **B** with Screws **Jx6**.



Step 4: Attach the assembled seat to the assembled base by aligning the hole in the tilt mechanism to the top of the gas lift. Push down firmly to secure. Now, enjoy your new chair!