

# ASSEMBLY INSTRUCTIONS

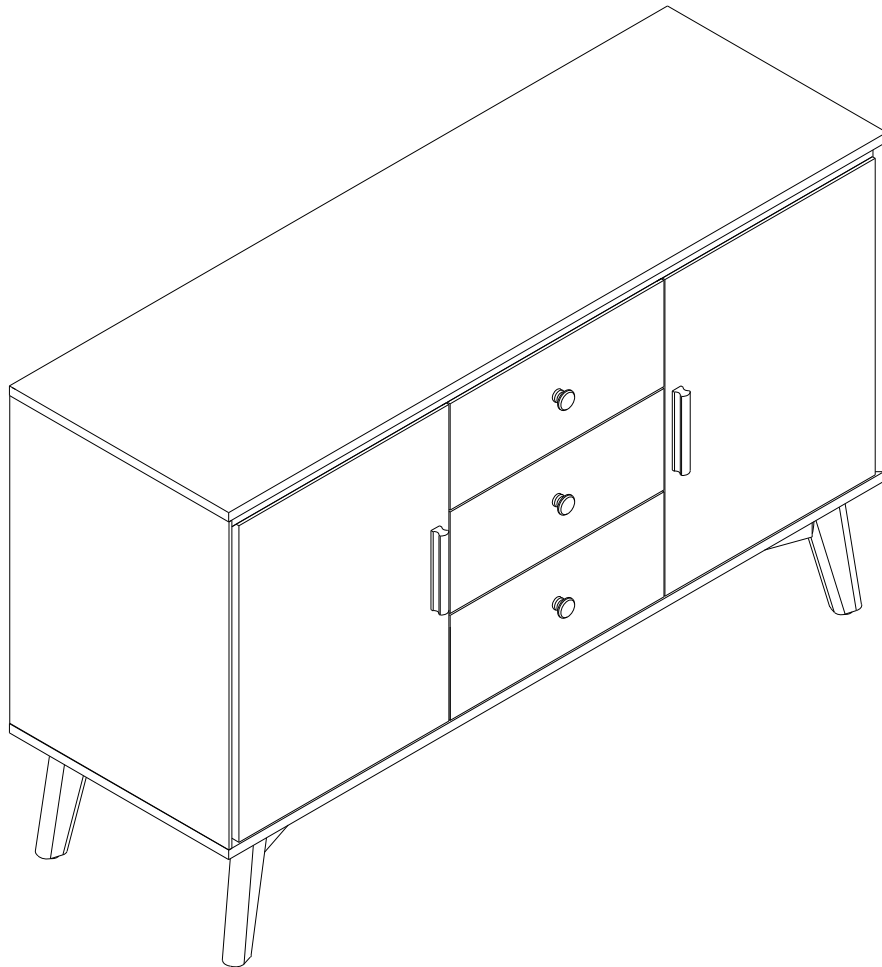

## Notice:

1. Follow the installation instructions. Please confirm all accessories are preset before installation.
2. Do not fully tighten the screws during initial assembly. Fully tighten screws only once all pieces which are correctly assembled.
3. If you encounter any problems during installation, please contact our customer service.
4. Please unbox the item from the side with an open-label and put a carpet on the floor to avoid scratching it.

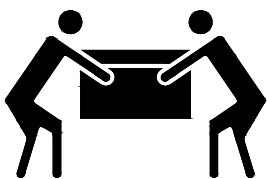

Recommended installers:2

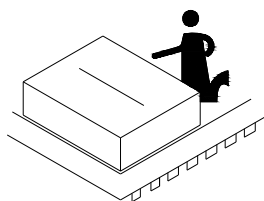

Put a carpet on the floor  
before unpacking

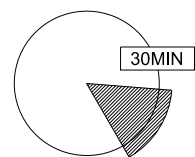

Estimate installation time:  
30minutes

# ASSEMBLY INSTRUCTIONS

## PART LIST

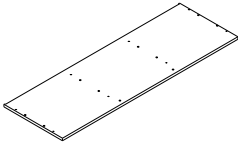
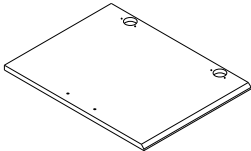
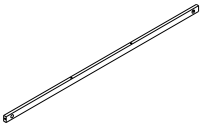
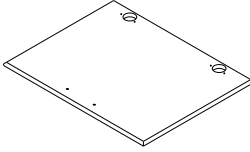
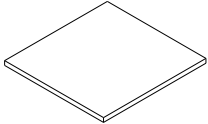
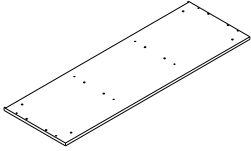
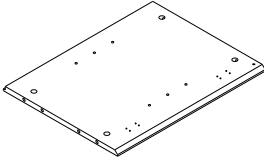
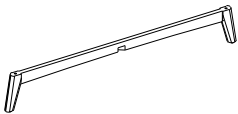
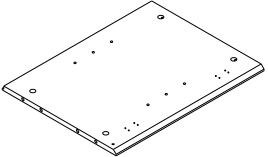
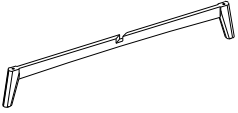
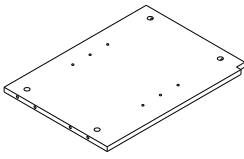
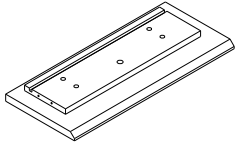
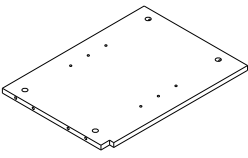
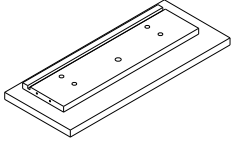
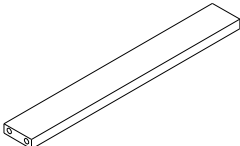
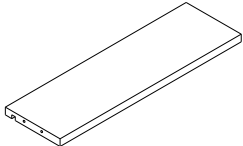
Item no.	Reference Image	Qty	Item no.	Reference Image	Qty
(A)		X1	(I)		X1
(B)		X1	(J)		X1
(C)		X2	(K)		X1
(D)		X1	(L)		X1
(E)		X1	(M)		X1
(F)		X1	(N)		X1
(G)		X1	(O)		X2
(H)		X2	(P)		X3





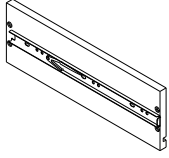
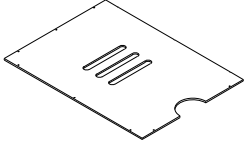
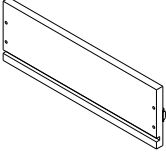
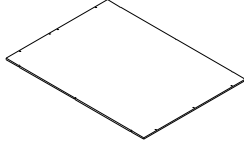
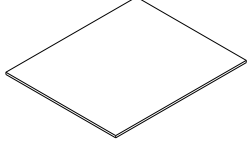
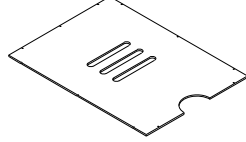

# ASSEMBLY INSTRUCTIONS

## PART LIST

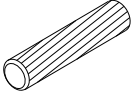
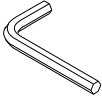
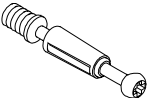
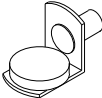
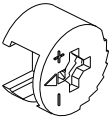
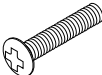
Item no.	Reference Image	Qty	Item no.	Reference Image	Qty
Q		X3	T		X1
R		X3	U		X1
S		X3	V		X1

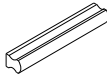
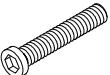
# ASSEMBLY INSTRUCTIONS

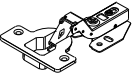
## HARDWARE LIST

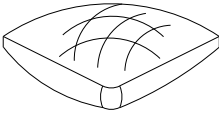
Item no.	Reference Image	Qty	Item no.	Reference Image	Qty
1	 Ø8*30mm	X22+2	8		X1
2		X22+2	9		X8
3		X22+2	10		X7
4	 Ø6.5*Ø3*15mm	X26+2	11		X2
5	 Ø1/4*1-3/4"	X4	12		X3
6		X4	13	 Ø7*Ø4*35mm	X24+2
7	 Ø6.5*Ø3*14mm	X24+2	14		X1

# ASSEMBLY INSTRUCTIONS

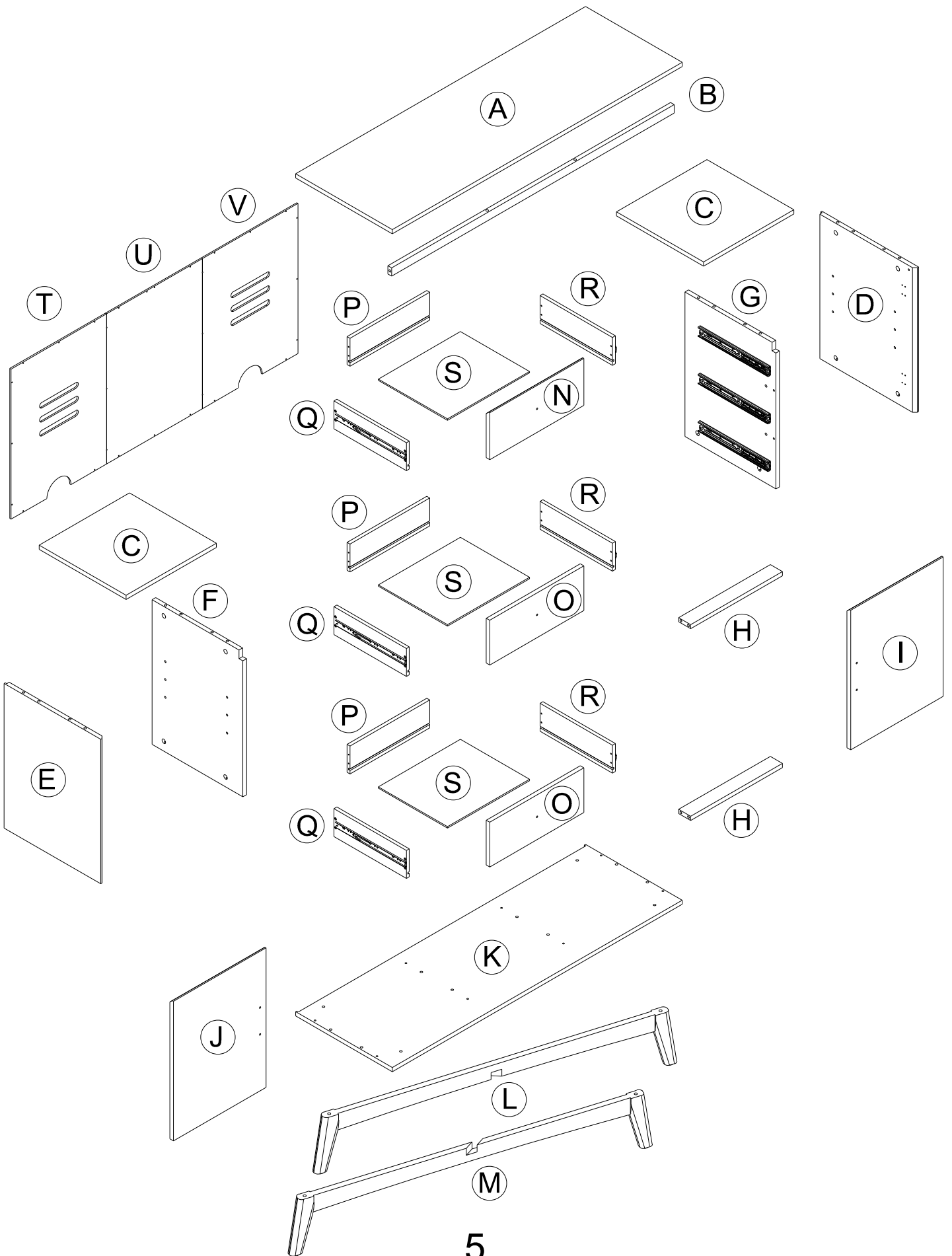

# ASSEMBLY INSTRUCTIONS

1

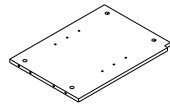

F 1pc

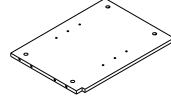

G 1pc

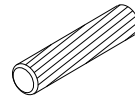

1 4pcs

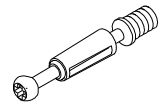

2 4pcs

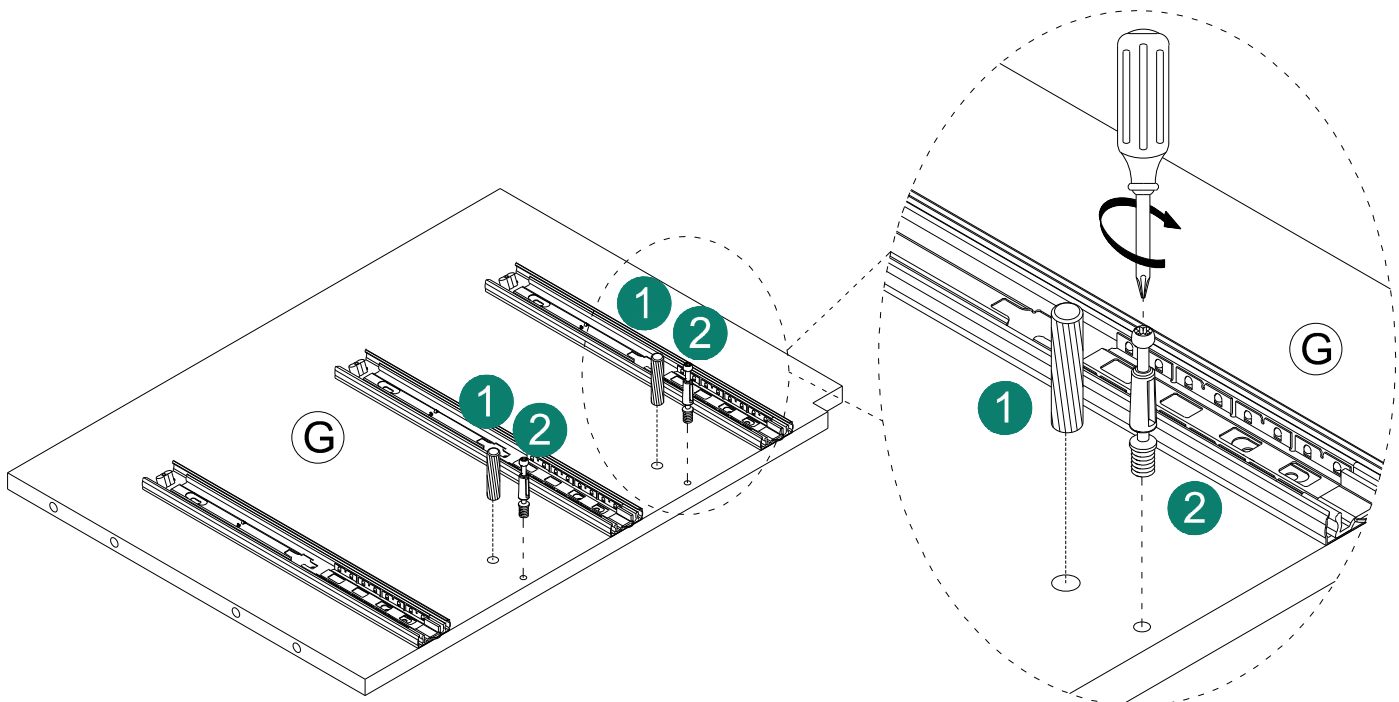
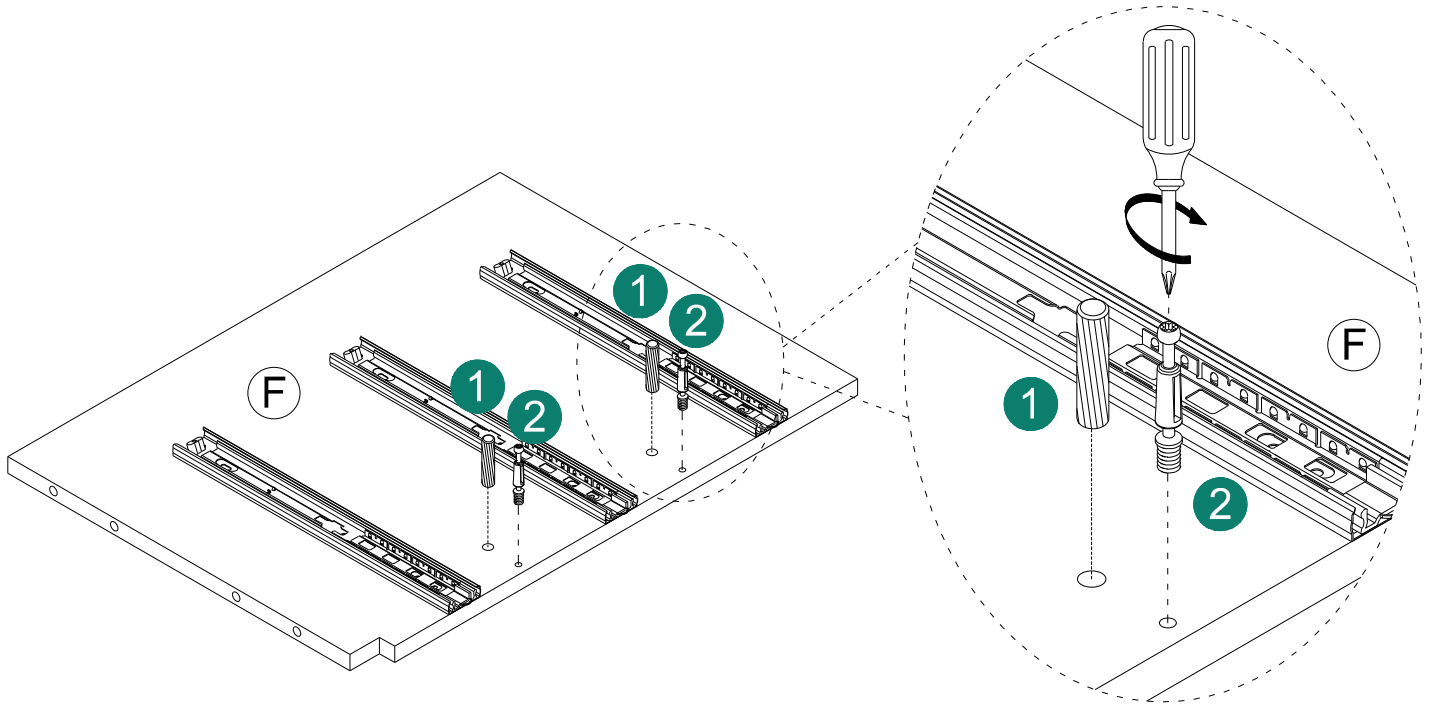

# ASSEMBLY INSTRUCTIONS

2

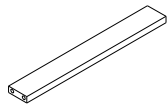

(H) 2pc

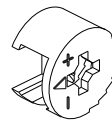

(3) 4pcs

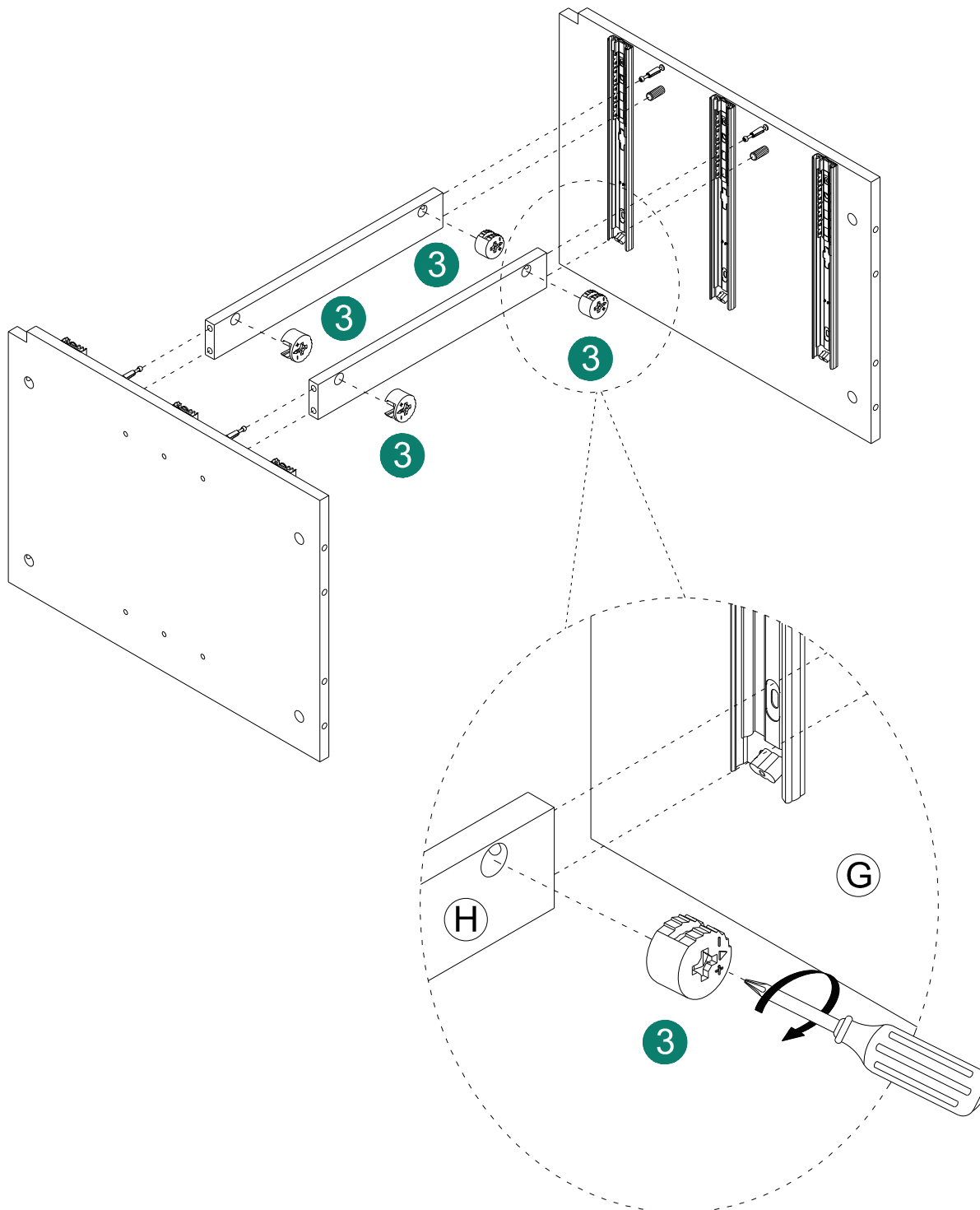

# ASSEMBLY INSTRUCTIONS

3

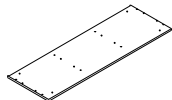

(K) 1pc



(L) 1pc

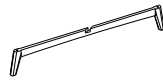

(M) 1pc

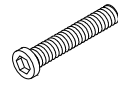

(5) 4pcs

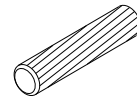

(1) 8pcs

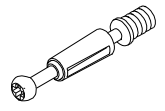

(2) 8pcs

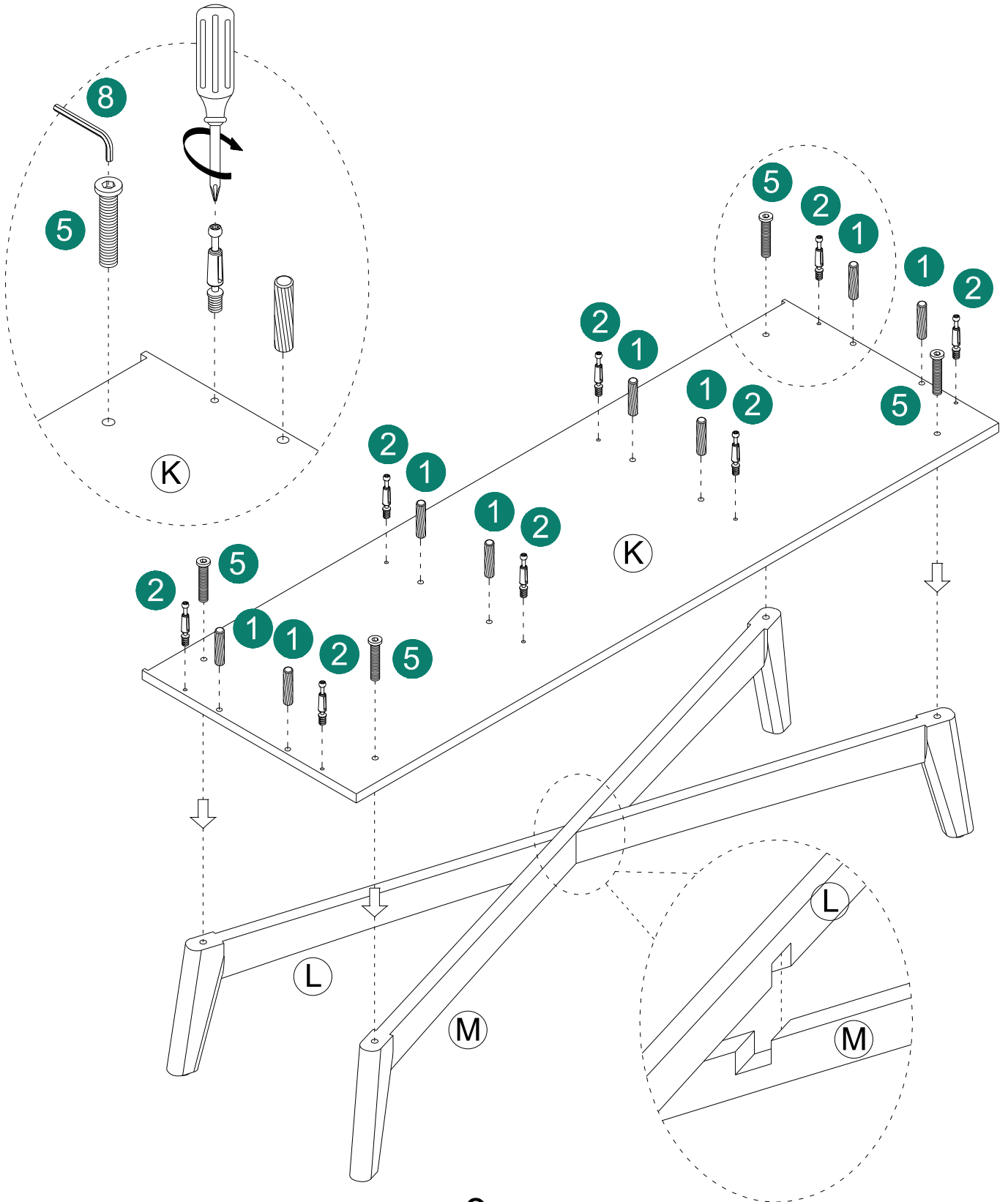

# ASSEMBLY INSTRUCTIONS

4

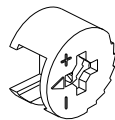

3 4pcs

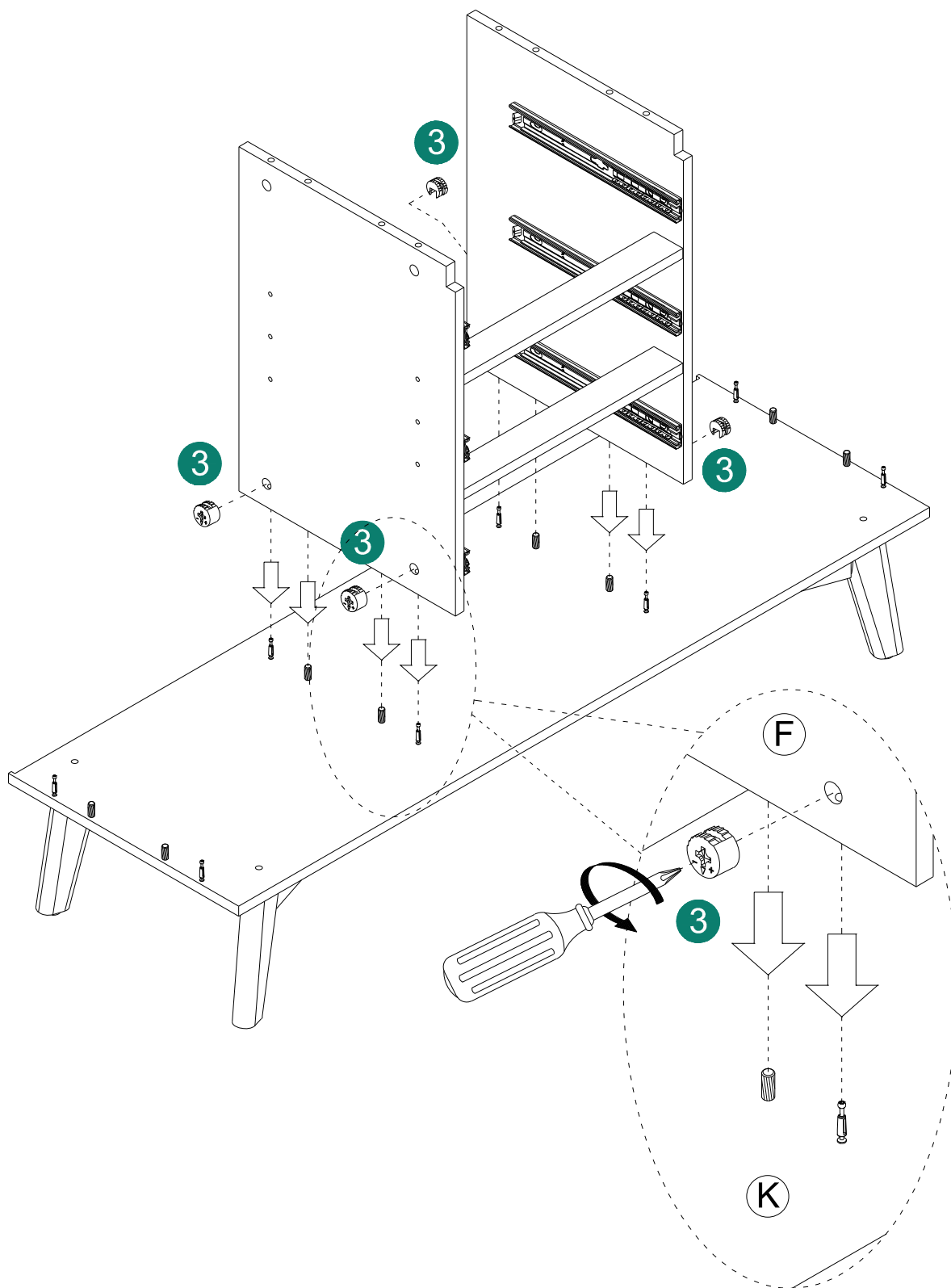

# ASSEMBLY INSTRUCTIONS

5

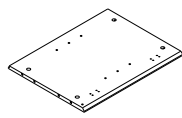

(E) 1pc

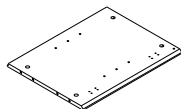

(D) 1pc

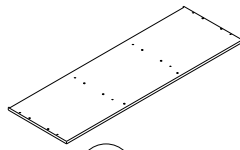

(A) 1pc

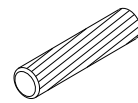

(1) 8pcs

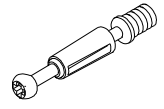

(2) 8pcs

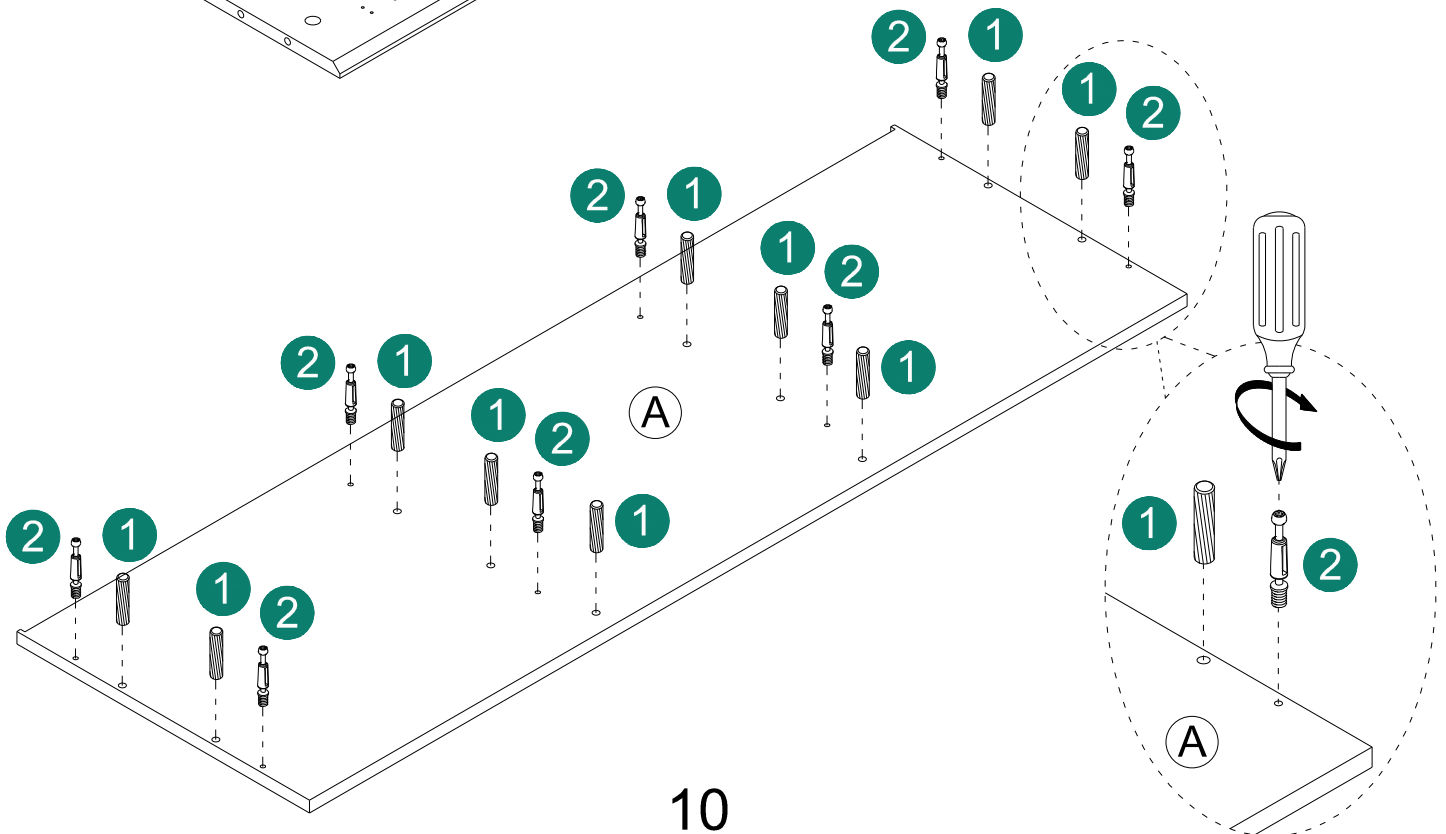
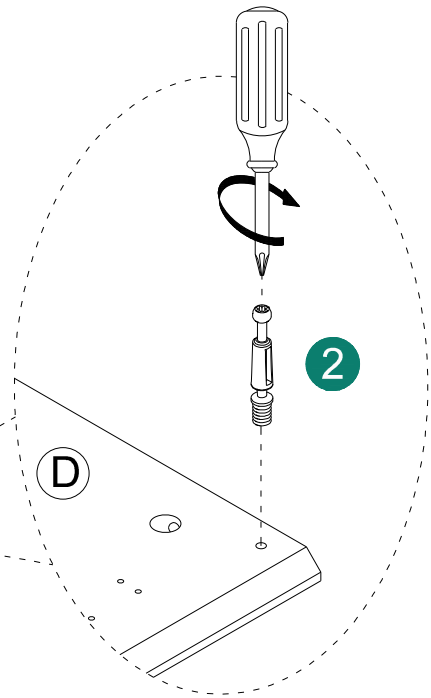
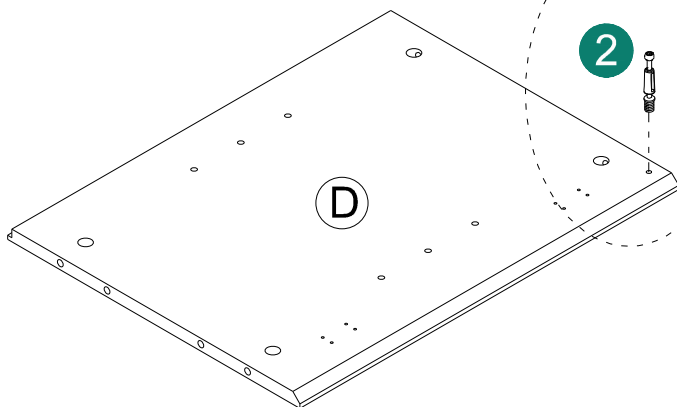
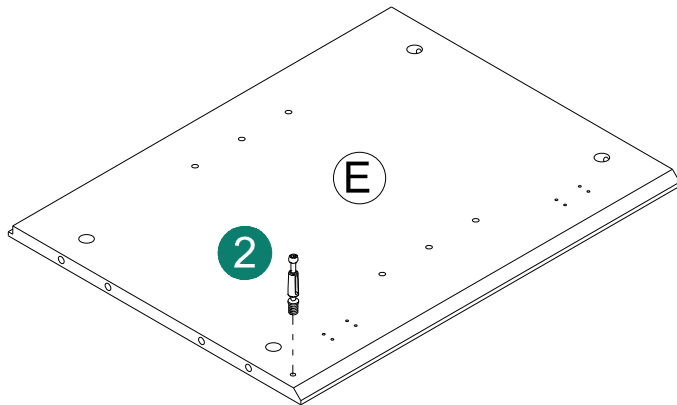

# ASSEMBLY INSTRUCTIONS

6

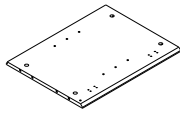

(E) 1pc

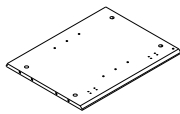

(D) 1pc

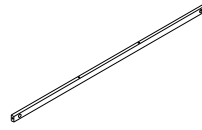

(B) 1pc

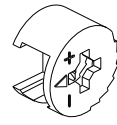

(3) 2pcs

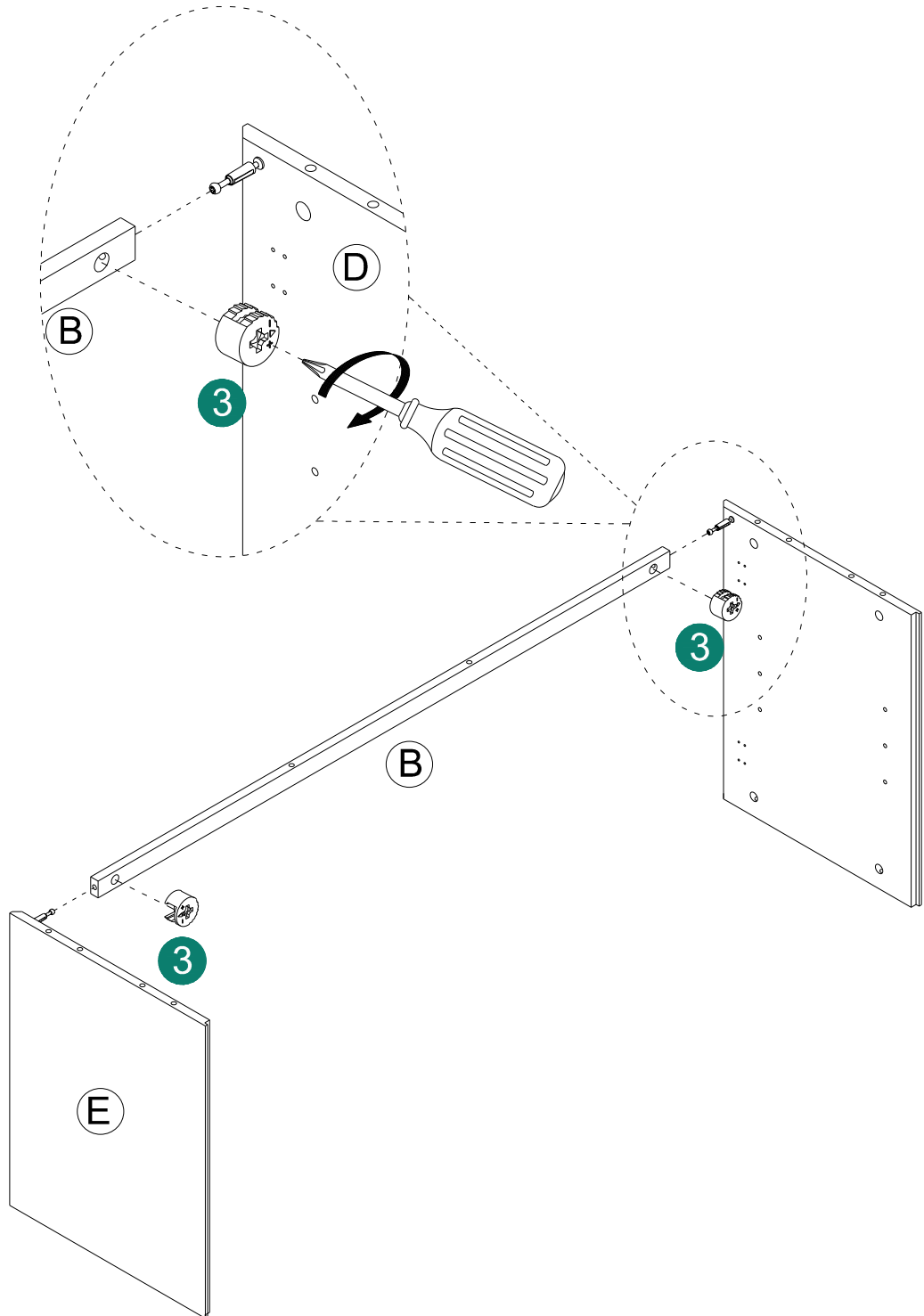

# ASSEMBLY INSTRUCTIONS

7

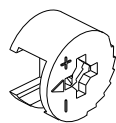

3 4pcs

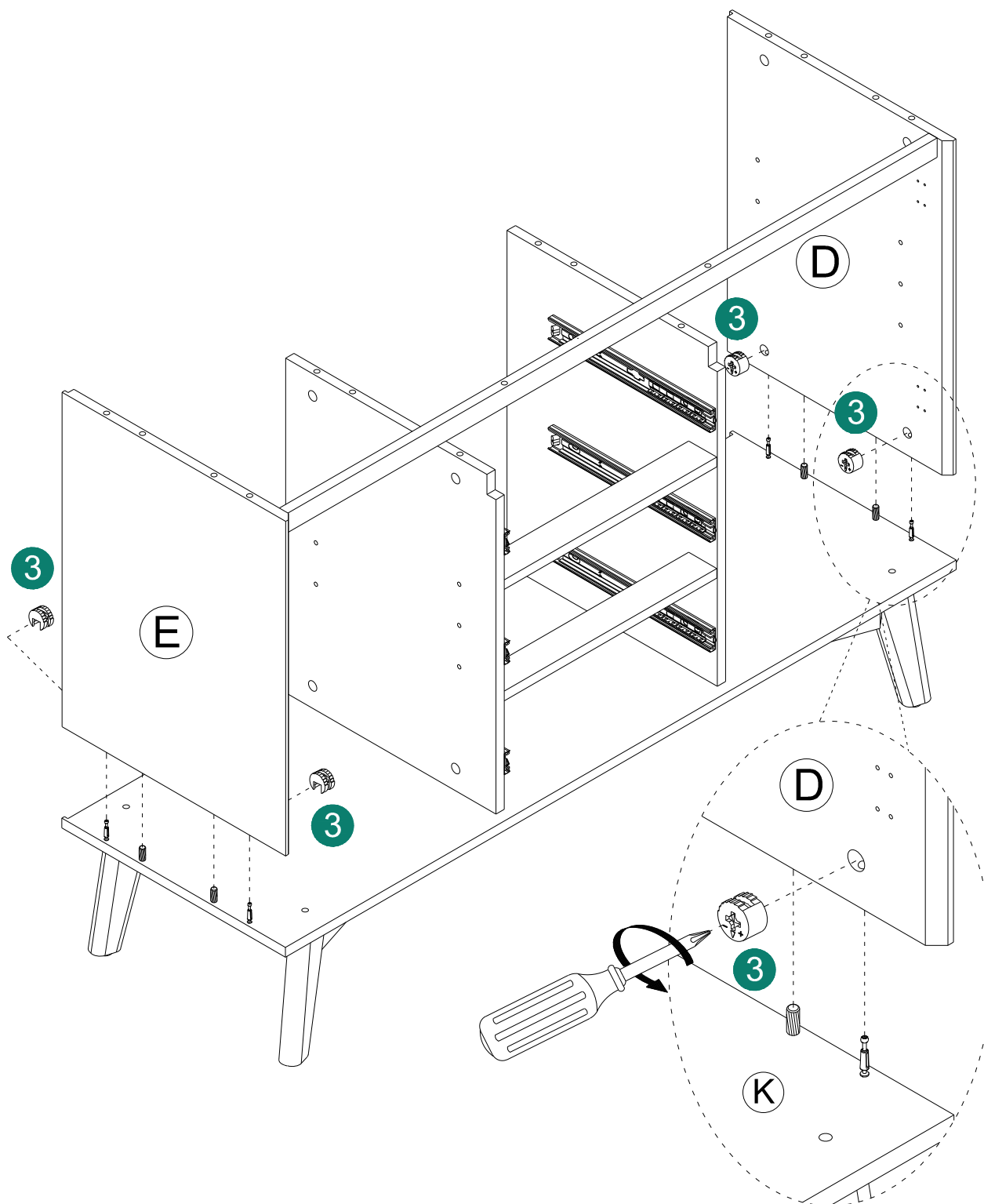

# ASSEMBLY INSTRUCTIONS

8

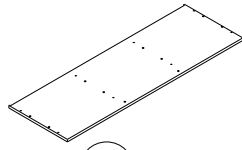

A 1pc

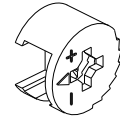

3 8pcs

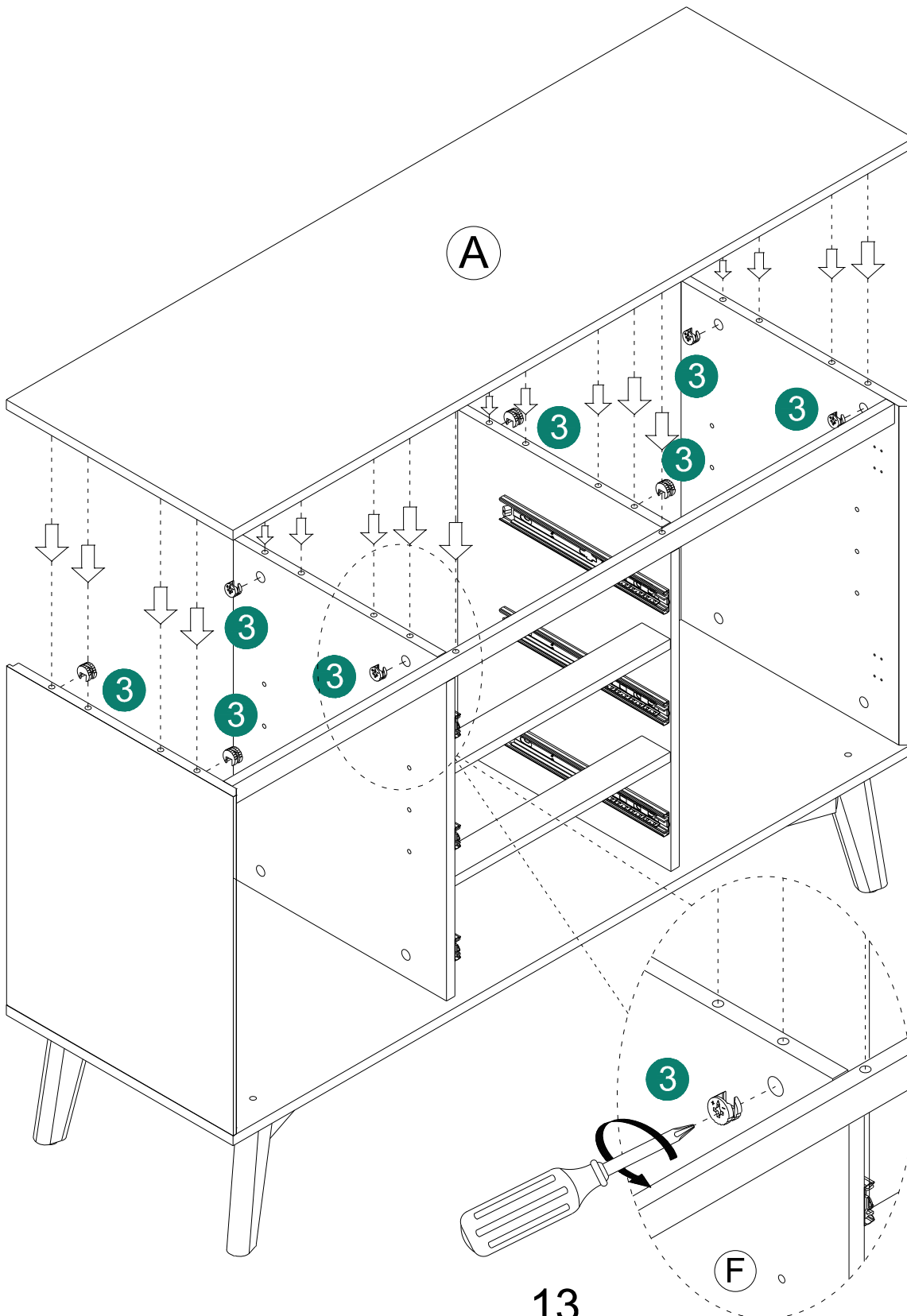

# ASSEMBLY INSTRUCTIONS

9

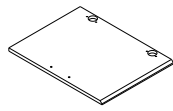

I 1pc

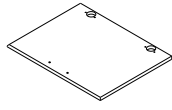

J 1pc



7 8pcs



6 4pcs

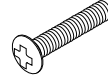

10 4pcs



11 2pcs

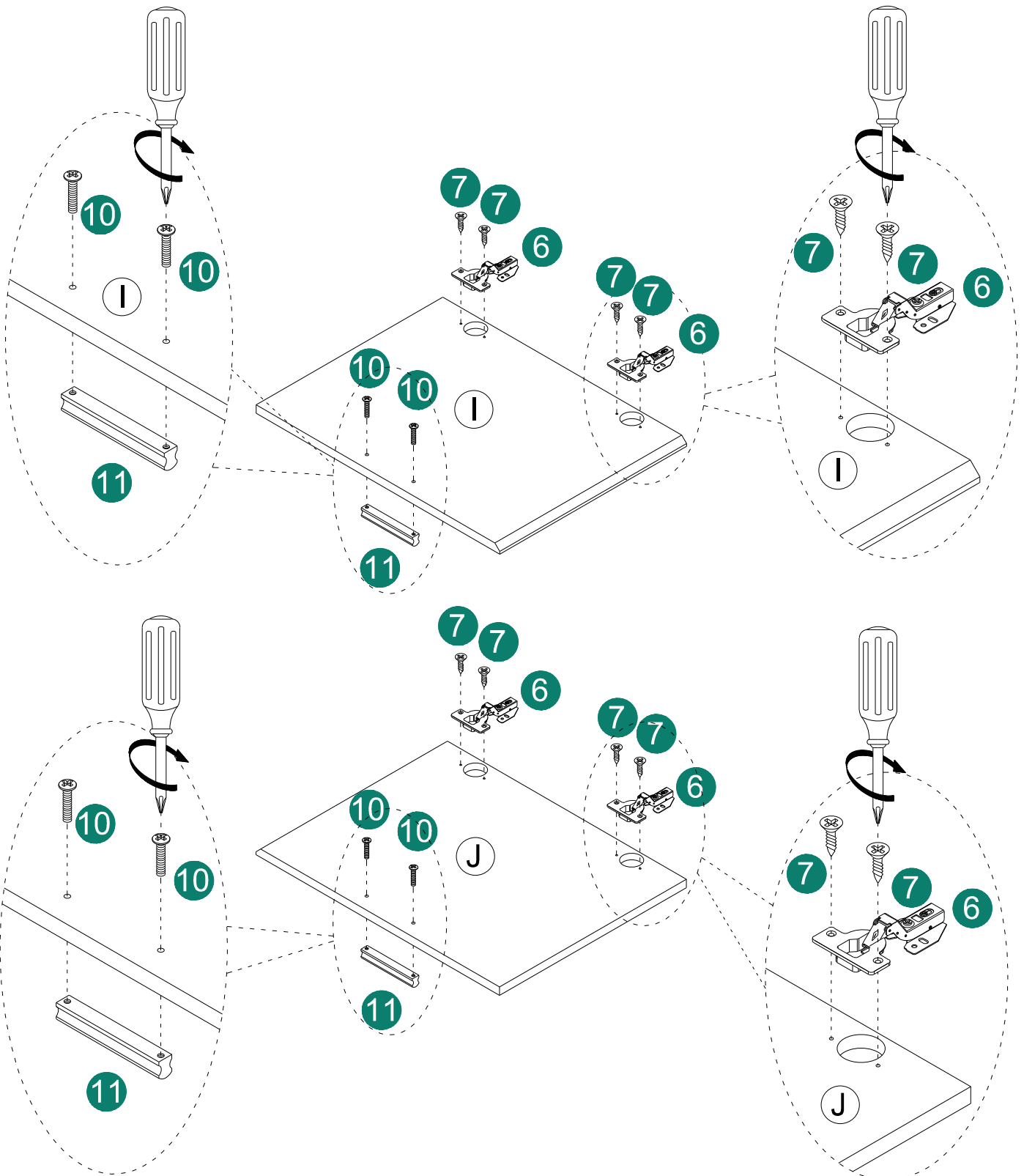

# ASSEMBLY INSTRUCTIONS

10

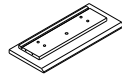

(N) 1pc

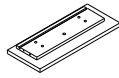

(O) 1pc



(Q) 3pc



(R) 3pc

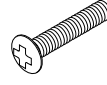

(10) 3pcs



(13) 12pcs



(12) 3pcs

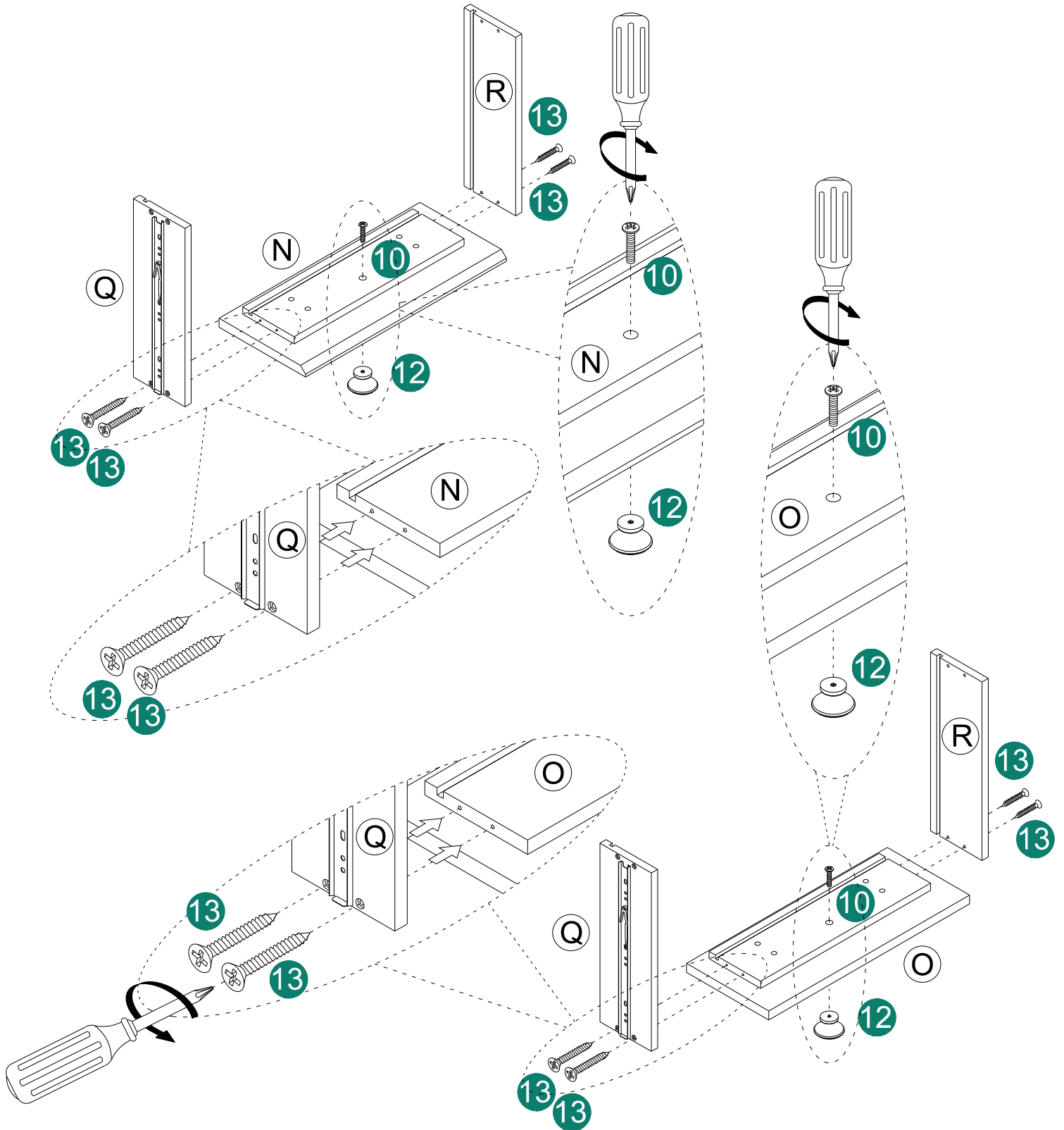

# ASSEMBLY INSTRUCTIONS

11

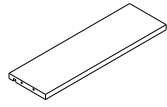

P 3pc

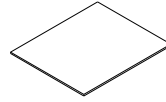

S 3pc



13 12pcs

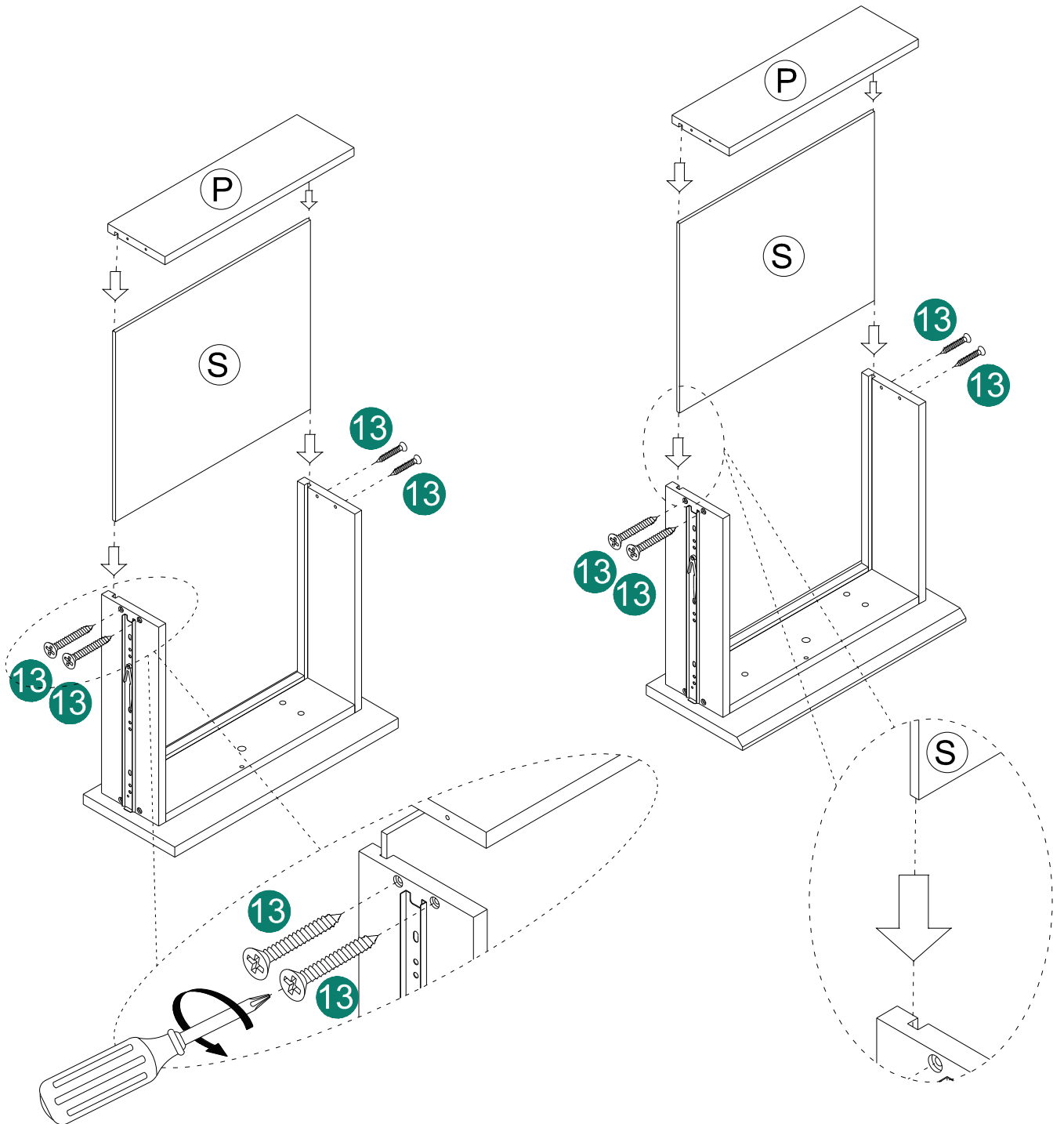

# ASSEMBLY INSTRUCTIONS

12



⑦ 16pcs

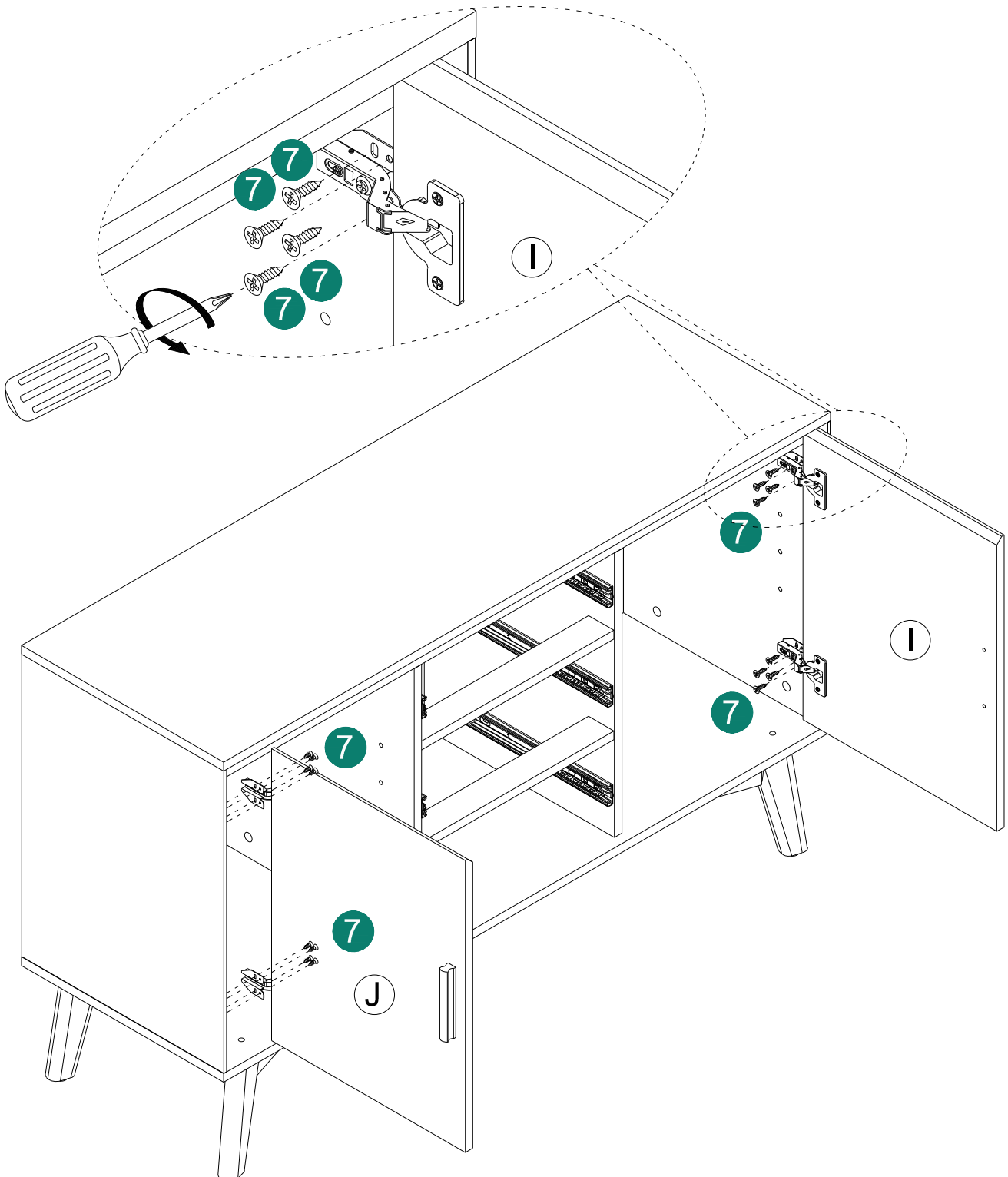

# ASSEMBLY INSTRUCTIONS

13

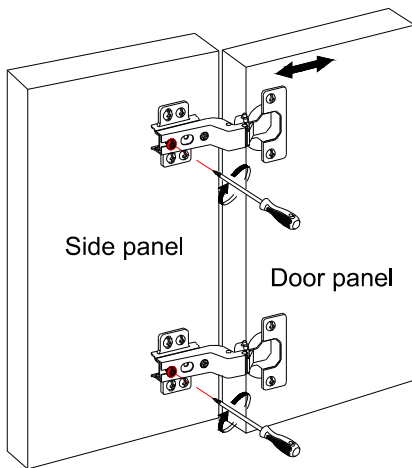

①

## Front-to-Back Direction Adjustment:

Rotate the screws on the door hinges shown in the image. The door panel can be moved front-back.

Adjustment range: 4mm

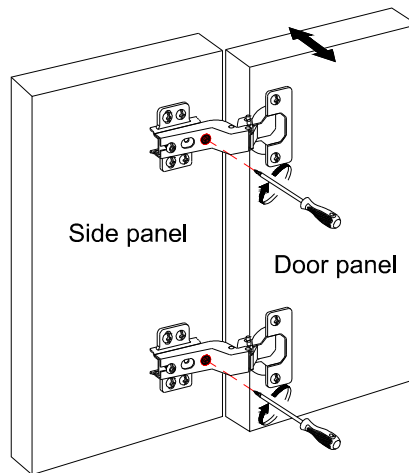

②

## Left-Right Direction Adjustment:

Rotate the screws on the door hinges shown in the image. The door panel can be moved left-right.

Adjustment range: 3mm

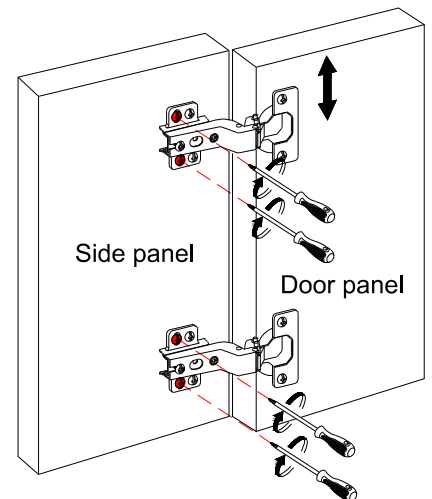

③

## Up-Down Direction Adjustment:

Rotate the screws on the door hinges shown in the image. The door panel can be moved up-down.

Adjustment range: 4mm

# ASSEMBLY INSTRUCTIONS

14

## Common Door Panel Issues:

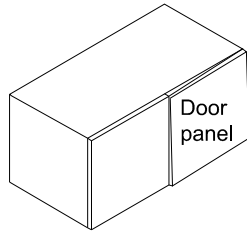

Door panel is not straight

Adjust the door hinges

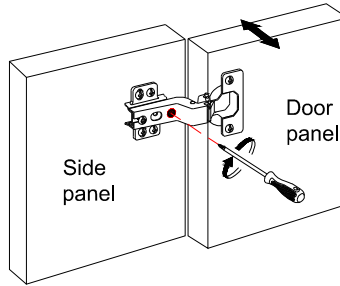

Finished

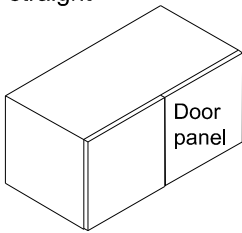
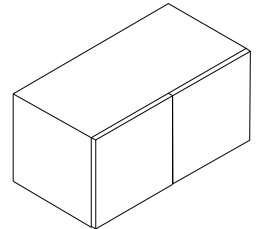
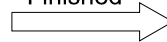

The gap between door panels is too large

Adjust the door hinges

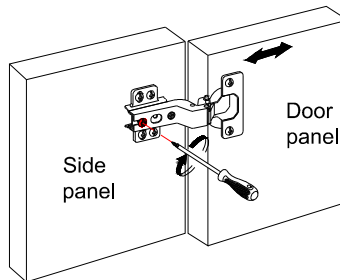
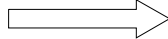

Finished

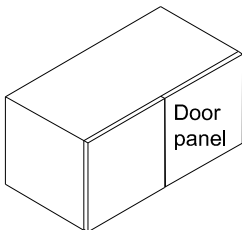
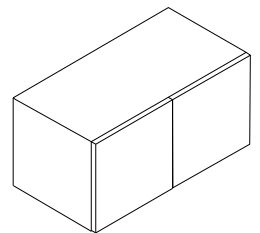
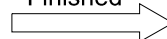

The door panels are not coplanar

Adjust the door hinges

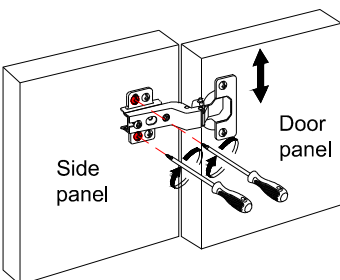
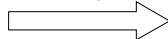

Finished

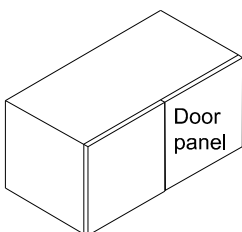
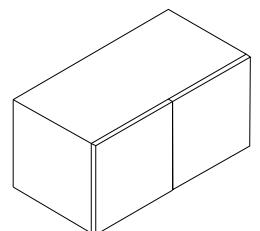
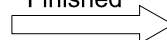

The two door panels are not at the same height

Adjust the door hinges

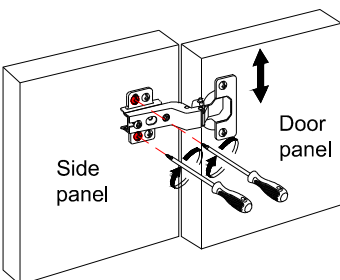
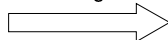

Finished

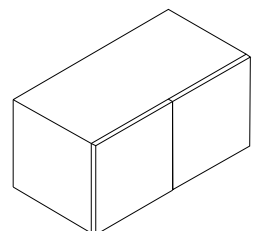
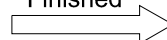

# ASSEMBLY INSTRUCTIONS

15

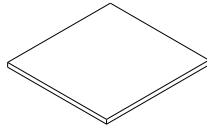

C 2pc



9 8pcs

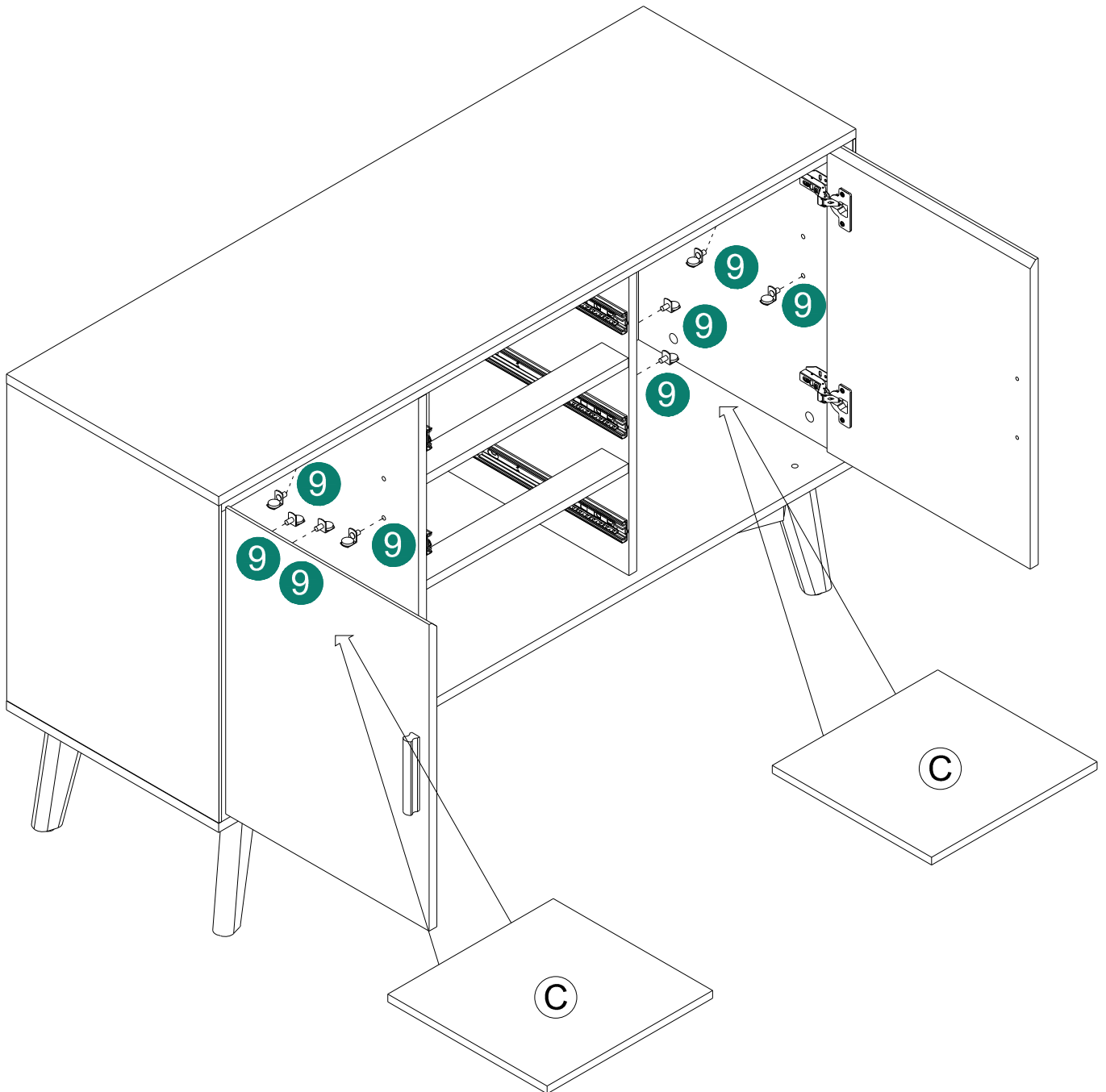

# ASSEMBLY INSTRUCTIONS

16

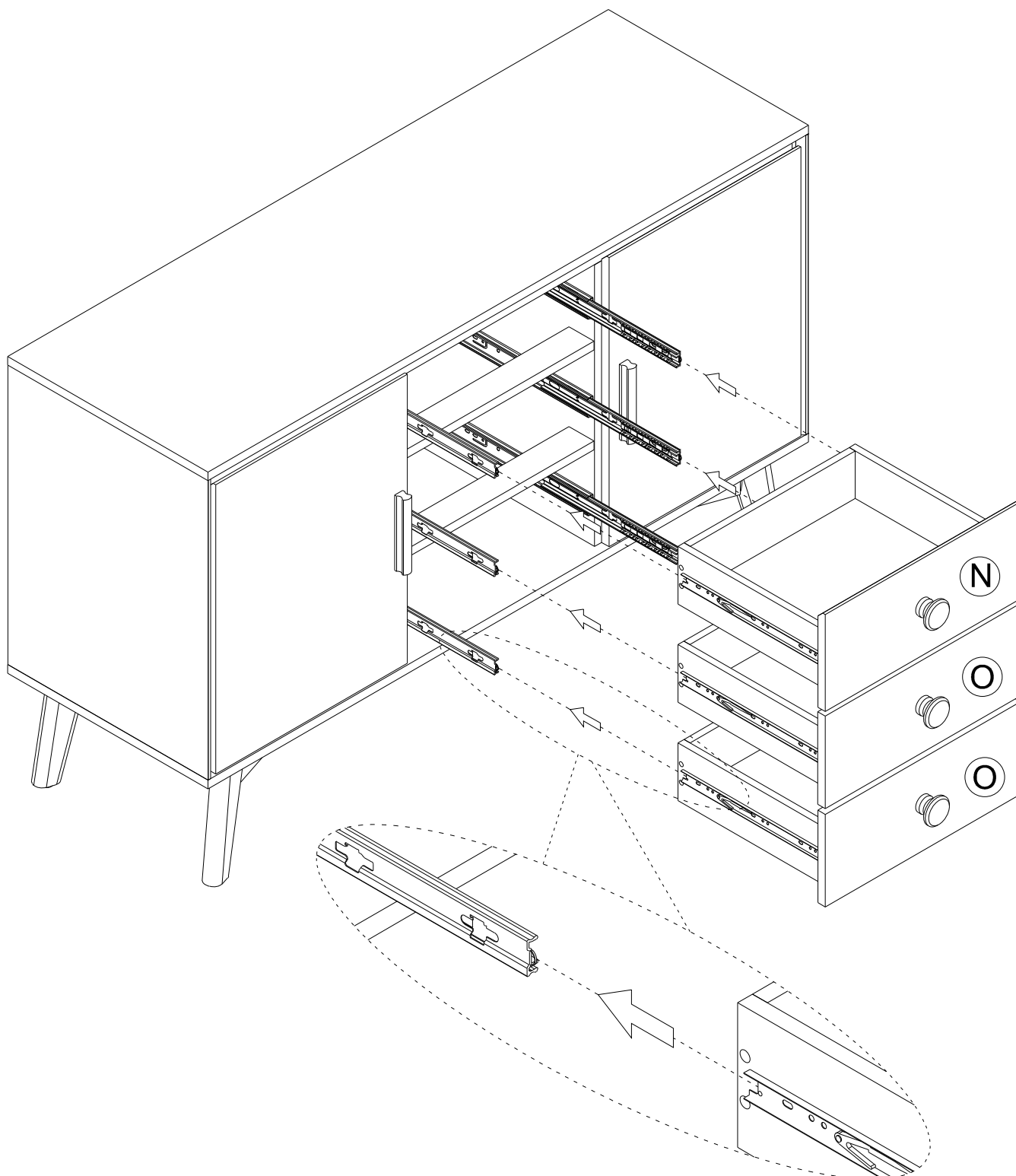

# ASSEMBLY INSTRUCTIONS

17

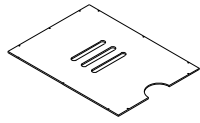

T 1pc

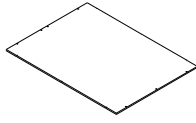

U 1pc

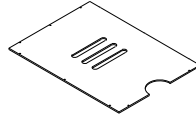

V 1pc



4 26pcs

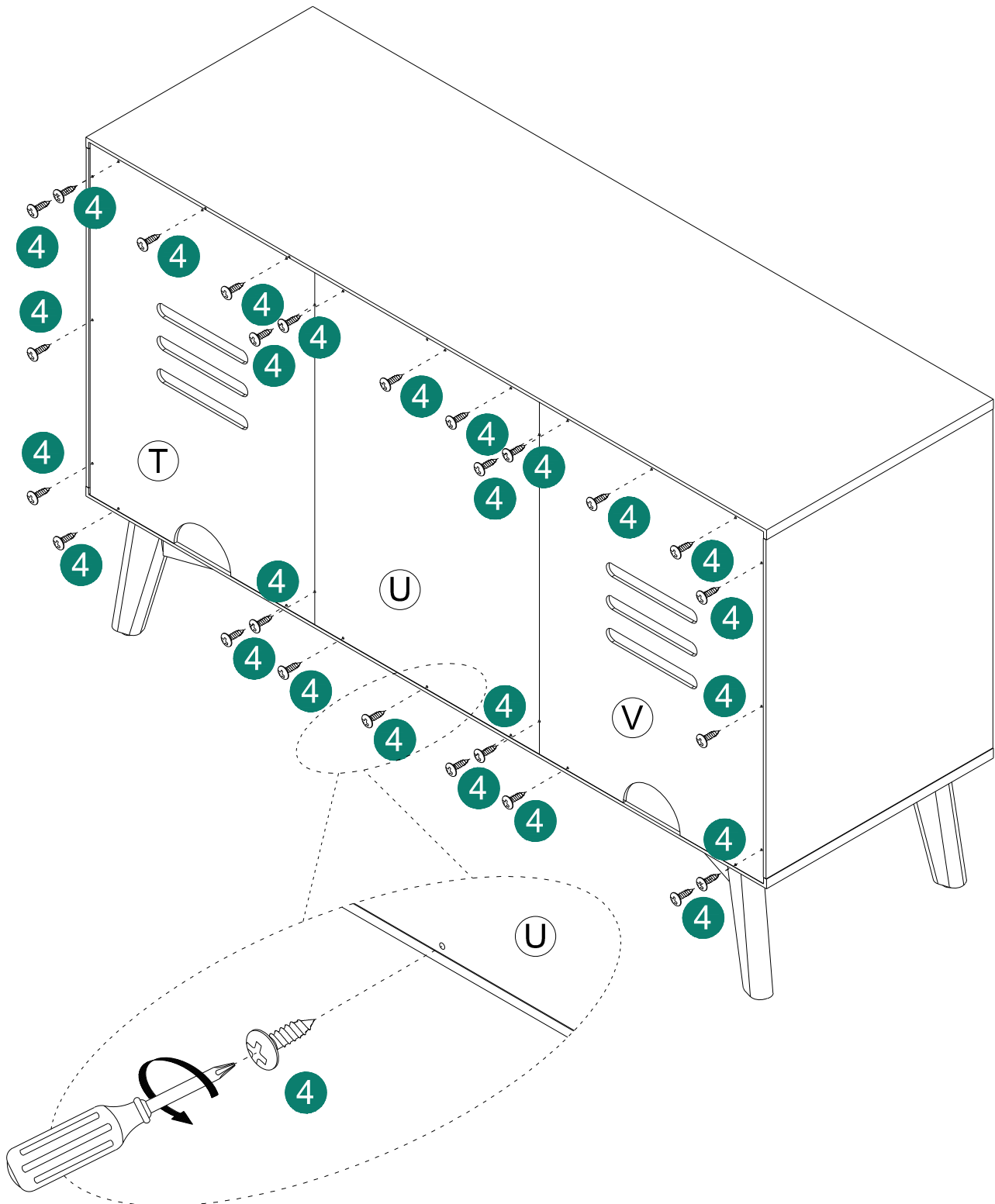

# ASSEMBLY INSTRUCTIONS

18

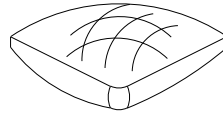

14 1set

A

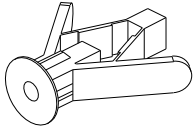

1pcs

B

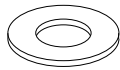

2pcs

C

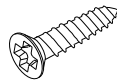

Ø8\*3/4"

1pcs

D

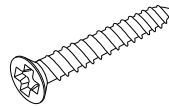

Ø8\*1-1/2"

1pcs

E

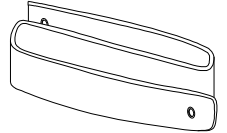

1pcs

WALL

