

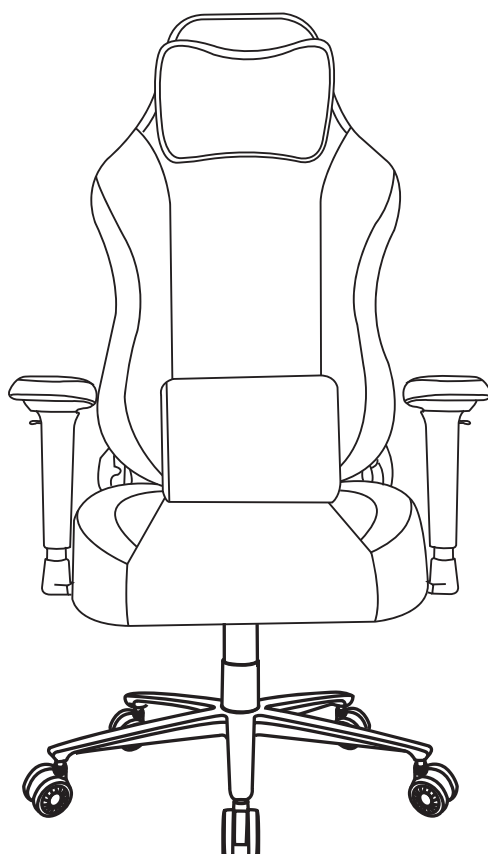









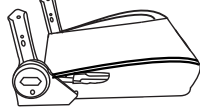

**MAGNETIC GAMING CHAIR**  
**ASSEMBLY INSTRUCTIONS**

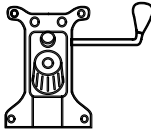

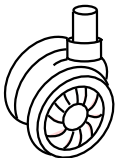
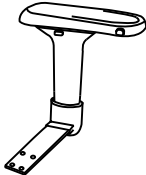

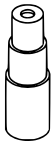
Do a quick inventory of all the parts and hardware listed below.



We will replace the part free of charge, while **the customer is responsible for shipping costs plus any International local taxes or duties.**

MAIN PARTS LIST					
<b>A</b> x1	<b>Backrest</b> 	<b>B</b> x1  <div style="background-color: #cccccc; padding: 2px; font-size: 8px;">* Please see below for important note about the brackets.</div>	<b>C</b> x1 	<b>D</b> x1 <b>Mechanism</b> 	<b>E</b> x1 <b>Lift cylinder</b> 
<b>F</b> x5 <b>Caster</b> 	<b>G-L</b> x1 <b>Left armrest, multi-function</b>  <div style="display: inline-block; vertical-align: middle; margin-left: 10px;">       (Front)  <div style="background-color: #cccccc; padding: 2px; font-size: 8px;">Sitting on the chair, not looking at it</div> </div>		<b>G-R</b> x1 <b>Right armrest, multi-function</b>  <div style="display: inline-block; vertical-align: middle; margin-left: 10px;">       (Front)  <div style="background-color: #cccccc; padding: 2px; font-size: 8px;">Sitting on the chair, not looking at it</div> </div>		
<b>H</b> x1 <b>Lift cover, Set of 3 cones</b> 	<b>I-L</b> x1 <b>Left cover for seat bracket</b> (Front) ← 	<b>I-R</b> x1 <b>Right cover for seat bracket</b>  (Front)	<b>J-L</b> x1 <b>Lumbar pillow</b> 	<b>J-N</b> x1 <b>Magnetic Neck pillow</b> 	
* The left metal bracket on the seat is loose, while the right is stiff and can only move until the chair is assembled.					

### HARDWARE LIST

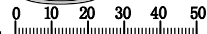
Part #	QTY	SIZE/Description	Item
M	16	M8x25 Captive washer + o'ring screw	 
N	2	Ø8, Ø25 Felt gasket	 

### INCLUDED TOOLS

1	M6 Allen Wrench	
---	-----------------	---

**BEFORE YOU START THE ASSEMBLY, PLEASE READ THE FOLLOWING TIPS AND WARNINGS.**

- Do not discard this manual or any of the packaging material until the unit is completely assembled.
- Please read the assembly instructions thoroughly and follow step by step.



- Make sure you understand which hardware will be used on each step. Using the wrong size of screw, bolt or pin might strip the threads or cause damage to the part in which it is being used.

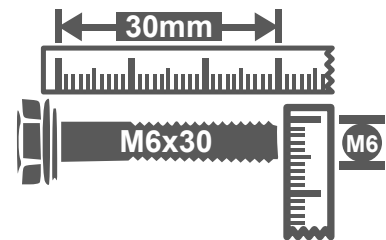
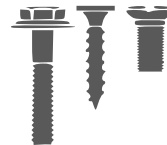

- To avoid misalignments, always leave the screws loosely and do not tighten them until all the pieces are positioned correctly.

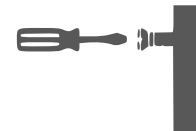

- Do not overtighten or force the screws as they might break, strip, damage the threads of the holes, or get stuck inside the parts.

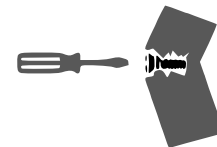

- If the hole seems to small for the screw, make sure you are using the correct size of screw and/or that you are installing it in the correct hole.



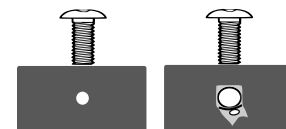

- Sometimes the fabric or material might cover partially or entirely the screw hole, making the hole appear to be too small or not visible at all.



**ASSEMBLY STEPS**

**STEP 1**

**Hardware**

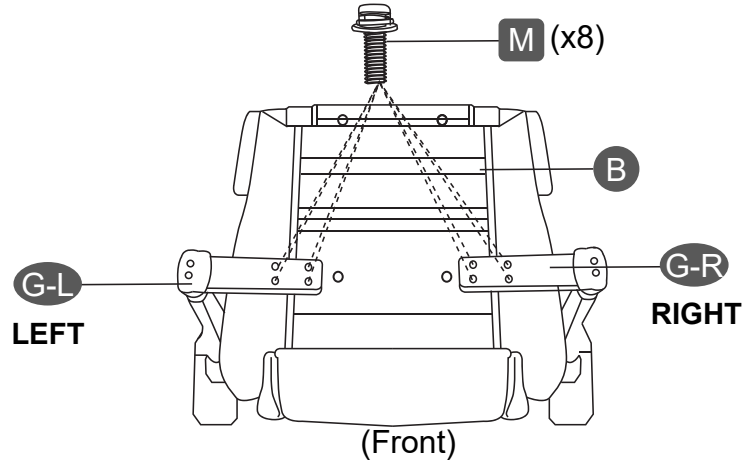

<b>M</b>		8 Pcs
<b>M6</b>		

Turn over the seat **B** and assemble the armrests **G-L**, **G-R** in their respective sides with screws **M**. Please note that the armrest side (left or right) is you sitting on the chair, not looking at it.



**STEP 2**

**Hardware**

<b>M</b>		4 Pcs
<b>N</b>		2 Pcs
<b>M6</b>		

First place the felt gaskets **N** over the 2 holes on the middle of the seat frame **B**, then assemble the mechanism **D** with screws **M**, making sure the tension knob faces towards the front.

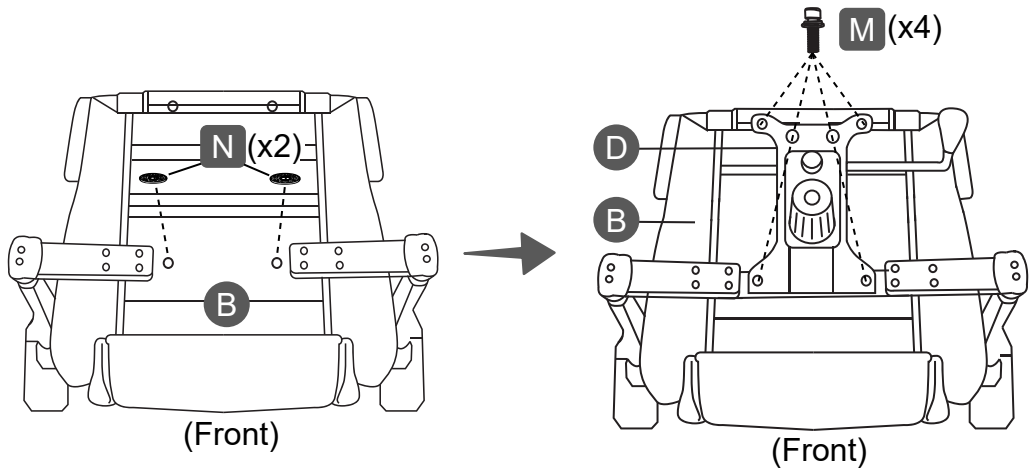

**STEP 3**

Insert the casters **F** into each leg of the base **C** using pressure, then place the lift cylinder **E** in the middle of the base and cover it with **H**.

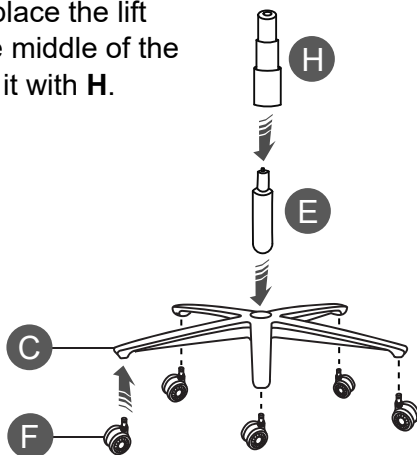

**STEP 4**

Join the base parts to the seat making sure the tip of the lift **E** enters correctly into the hole of the mechanism **D**.

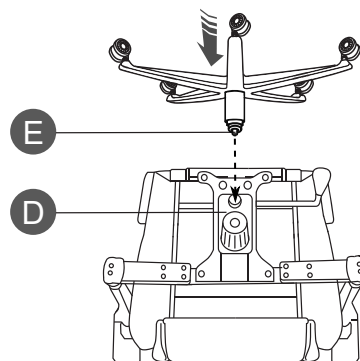

**STEP 5**

**Hardware**

**M**  4 Pcs

**M6** 

Assemble the backrest **A** to the metal brackets on the seat **B** with screws **M**, but leave them all loose to avoid misalignments, and once they are in their respective places, proceed to tighten them.

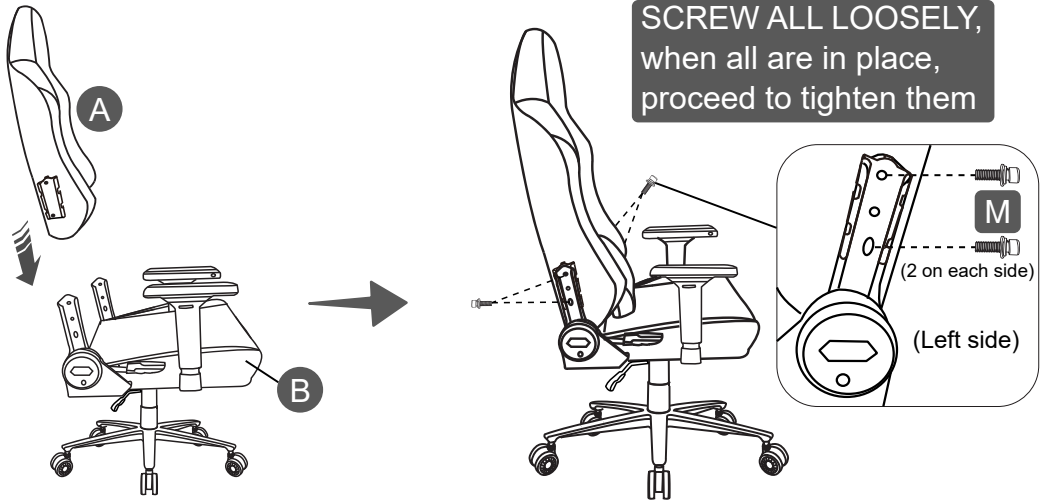

**STEP 6**

Attach the covers **I-L** and **I-R** to the metal brackets on their respective sides by aligning first the tabs on **I** with the slots on the brackets, then slide **I** down.

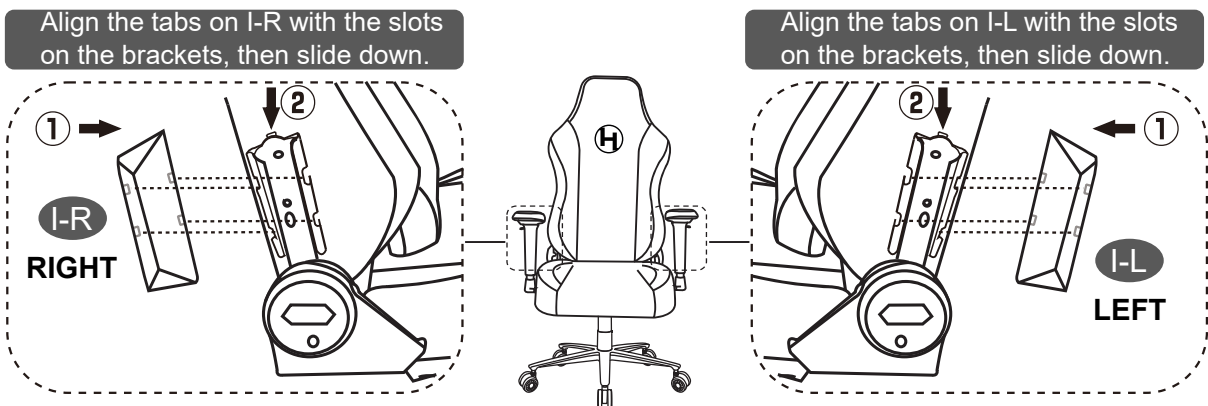

**STEP 7**

Attach the magnetic head pillow **J-N** to the backrest **A** and the lumbar pillow **J-L**. Please note that the lumbar pillow is not magnetic nor has traps or other fastening device.

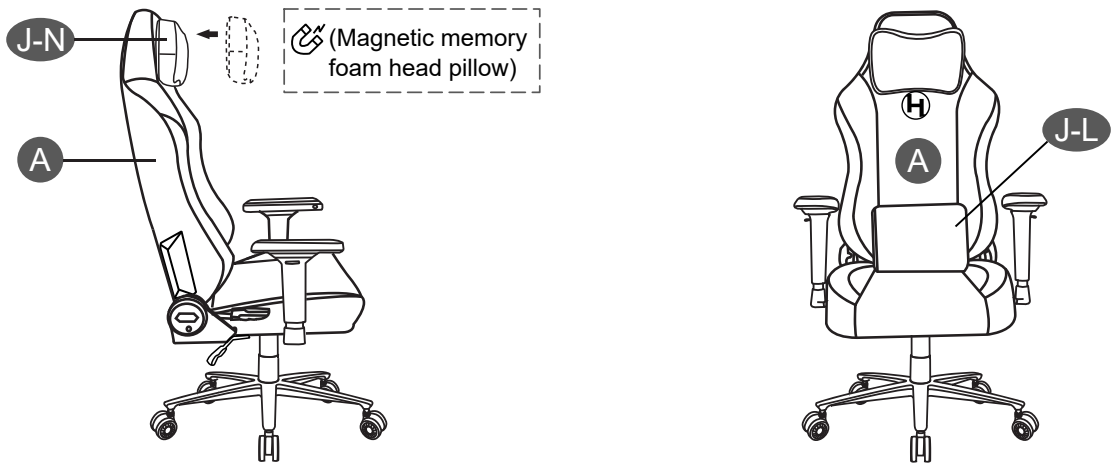

### CHAIR'S FUNCTIONS

- ① To raise or lower the chair's height, pull UP the lever that is under the seat on the right side. The chair goes down while sitting on it, or up if you lift your body.
- ② The chair also tilts by pulling OUT the same lever to unlock, but please note that unlike regular chairs, gaming chairs have their balance centered farther back, so the chair feels harder to tilt.
- ③ The mechanism under the seat has a tension knob at the front that you can turn to apply more or less tension to the tilting function, but please refer to the notes in point 2 about the tilting.
- ④ To recline the backrest to a specific angle, pull UP the short lever located on the right side of the seat, recline and then release the lever to lock into the desired position.
- ⚠ **WARNING:** For your safety, the tilt's function ② should be in the LOCKED (IN) position prior to use the backrest reclining function ④.
- ⑤ To adjust the armrest height, press the button that is on the outside of the armrest and release it once the desired height is reached.
- ⑥ The armpads can pivot and slide sideways and front-back by pressing the inside buttons.

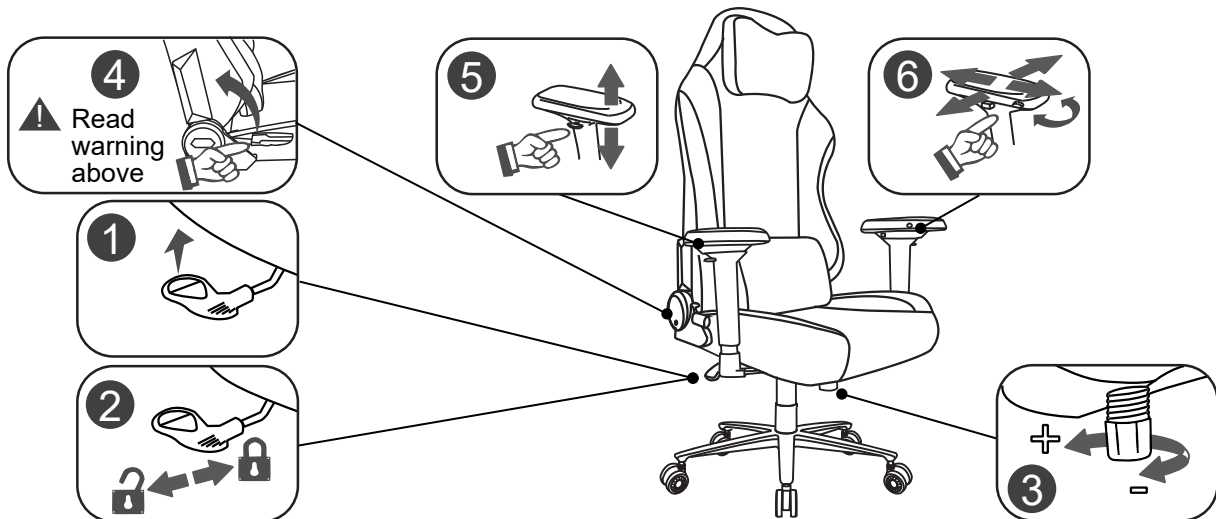

### WARNINGS

- Do not exceed the indicated weight limit.
- Do not stand up on the chair or use it as ladder.
- Only one person at a time can sit on the chair.
- Do not use the chair if parts are bent, damaged, or if screws are loose or missing.
- **NEVER** try to get up from the chair from a reclined position.
- If small children are sitting on the chair, keep close observation on them.
- Do not allow small children to play with the chair.
- Not paying attention to these warnings could result in injuries.

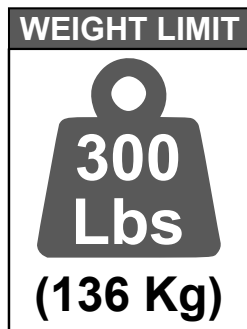

### CARE AND MAINTENANCE

- To clean the chair it is recommended to use a soft cloth lightly damped in a solution of smooth soap and water, then dry with a clean towel.
- Do not use solvents or abrasive materials to clean any part of the chair.
- Before using a cleaning agent, test on a small hidden area of the chair, like underneath the seat.
- Do not expose the product to direct sunlight or to extreme environmental conditions.
- Inspect the chair completely every 4 months and make sure that all screws are tighten. Do not use if parts are bent, damaged, or if screws are loose or missing.

## WARRANTY



**Gaming Chair:  
2-YEAR WARRANTY**



**Gaming Chair Internal Metal Frame\*:  
LIFETIME WARRANTY**

Has warranted the products to the original purchaser who acquired a new product or its authorized re-sellers of the product against defects in material or workmanship.

This warranty is expressly limited to the repair or replacement (at its option) of defective product components or materials as a result of a defect in materials or workmanship. This warranty is limited to merchandise purchased. No assembly labor is included. The word "defects" as used in this warranty, is defined as imperfections that impair the utility of the product.

This warranty applies under conditions of normal use, but does not apply to defects that result from intentional damage, wear & tear, negligence, unreasonable use or exposure.

Internal metal frame\*: Refers to the internal metal steel structure of the seat and back only.

Liability for consequential damages is excluded to the extent exclusion is permitted by law. This warranty gives you specific legal rights, and you may have other rights that vary.

Does not warrant: a) natural variations in character marks b) changes in surface finishes due to aging or exposure to light c) marks, scars, or wrinkles occurring naturally in leather d) failure resulting from normal wear and tear e) the matching of colors, grains, or textures of natural materials f) the colorfastness or the matching of textiles, including an exact match to cuttings or to swatch cards g) damage, marking, or staining of veneer surfaces due to contact with rubber or similar compounds, damage from sharp objects or imprinting from writing instruments, or prolonged exposure to direct sunlight h) we do not warrant products that are exposed to extreme environmental conditions or that have been subject to improper storage.

We shall not be liable for loss of time, inconvenience, commercial loss, or incidental or consequential damages.

Any modification to the original product voids the warranty. We do not warrant the performance of the product when used in combination with other than original products.

This product has been designed for and is intended for office, home-office and gaming use only. This warranty is Original Purchaser's sole remedy for product defects, and this warranty does not extend to any product, or damage to any product, caused by or attributed to abuse or misuse, products used for commercial or rental purposes, use modifications of, or attachments to the product, and products or parts not used, maintained, or extended here under is in lieu of any and all other warranties, express or implied, including without limitations any implied warranty or merchant ability or of fitness for a particular purpose.

Please provide pictures of the damage or defect. We determine that a replacement will remedy the situation, and in order to determine the extent or the cause of the defect, purchaser may be requested to send the part in question at purchaser's expense. Once we receive the part, we will examine it and determine whether the claim is valid (or not), and then proceed to send the replacement. We will ship the replacement at our expense.

Replacement Parts :We will replace the part free of charge, while the customer is responsible for shipping costs plus any International local taxes or duties.