

PARTS LIST / LISTE DES PIÈCES / LISTA DE PIEZAS
 DESCRIPTION / DESCRIPCIÓN : CONER CURIO / CUIRO EN COIN / VITRINA DE ESQUINA

▲ WARNING

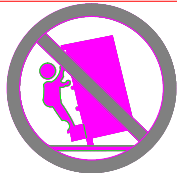

Serious or fatal crushing injuries can occur from furniture tip-over. To help prevent tip-over:

- install tipover restraint provided.
- Place heaviest items in the lowest drawers.
- Do not set TV's or other heavy objects on top of this product unless the product is specifically designed to accommodate them.
- Never allow children to climb or hang on drawers, doors, or shelves.
- Never open more than one drawers at a time (OR)
- Do not defeat or remove the drawers interlock system.

Use of tip-over restraints may only reduce, but not eliminate, the risk of tip-over. this is a permanent label. Do not remove!

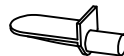
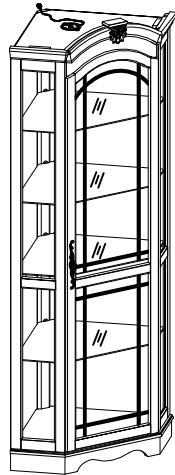
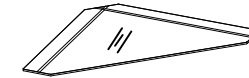
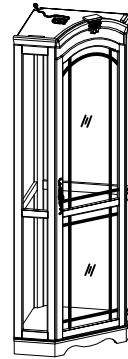

C

- x8 Common Shelf Support Flat*
- x8 Supports Pour Tablette
- x8 Soporte De Las Repisas

A

- x1 Corner Curio
- x1 Curio en coin
- x1 Vitrina de esquina



D

- x4 Common Shelf Support Slot*
- x4 Supports Pour Tablette
- x4 Soporte De Las Repisas

B

- x4 Glass shelf*
- x4 Étagère en verre
- x4 Estante de vidrio

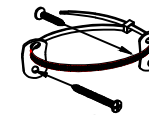

E

- x1 Furniture Tipping Restraint
- x1 Systeme antibasculement
- x1 Control para evitar vulcos

* Replaceable Part

ASSEMBLY INSTRUCTIONS / NOTICE DE MONTAGE / INSTRUCCIONES DE MONTAJE
DESCRIPTION / DESCRIPCIÓN : CONER CURIO / CUIRO EN COIN / VITRINA DE ESQUINA

▲ WARNING

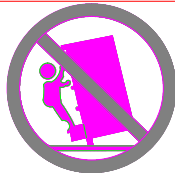

Serious or fatal crushing injuries can occur from furniture tip-over. To help prevent tip-over:

- install tipover restraint provided.
- Place heaviest items in the lowest drawers.
- Do not set TV's or other heavy objects on top of this product unless the product is specifically designed to accommodate them.
- Never allow children to climb or hang on drawers, doors, or shelves.
- Never open more than one drawers at a time (OR)
- Do not defeat or remove the drawers interlock system.

Use of tip-over restraints may only reduce, but not eliminate, the risk of tip-over. this is a permanent label. Do not remove!

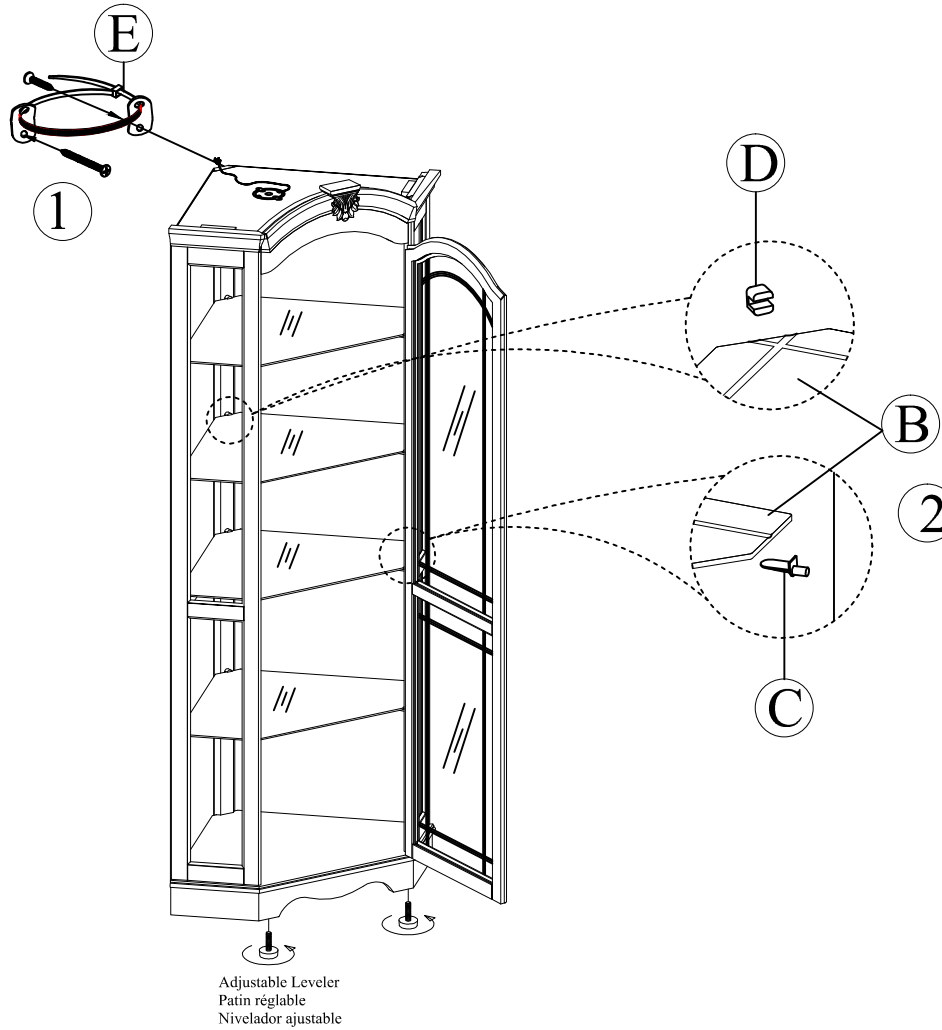
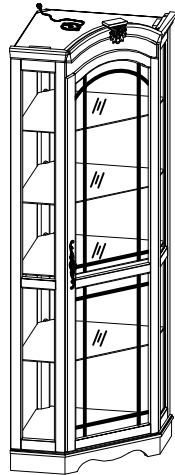

REPLACEABLE PART / PARTIE REMPLACABLE / PARTE REEMPLAZABLE
 DESCRIPTION / DESCRIPCIÓN : CONER CURIO / CUIRO EN COIN / VITRINA DE ESQUINA

▲ WARNING

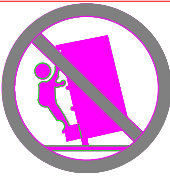

Serious or fatal crushing injuries can occur from furniture tip-over. To help prevent tip-over:

- install tipover restraint provided.
- Place heaviest items in the lowest drawers.
- Do not set TV's or other heavy objects on top of this product unless the product is specifically designed to accommodate them.
- Never allow children to climb or hang on drawers, doors, or shelves.
- Never open more than one drawers at a time (OR)
- Do not defeat or remove the drawers interlock system.

Use of tip-over restraints may only reduce, but not eliminate, the risk of tip-over. this is a permanent label. Do not remove!



x1
 Pull key and back plate*
 Tirer et Plaque
 Tira y Placa

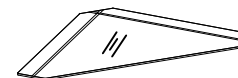

x4
 Glass shelf*
 Étagère en verre
 Estante de vidrio



x3
 Door catch*
 Catch de aimant
 Captura de imán

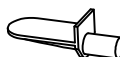
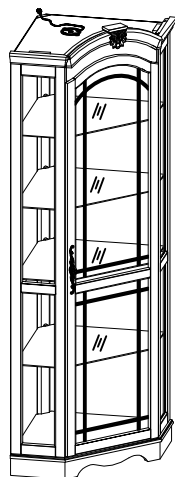

x8
 Common Shelf Support Flat*
 Supports Pour Tablette
 Soporte De Las Repisas



x4
 Common Shelf Support Slot*
 Supports Pour Tablette
 Soporte De Las Repisas

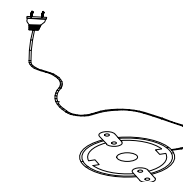

x1
 Light fixture w/roll switch*
 lumière et interrupteur
 luz y interruptor

* Replaceable Part