

ASSEMBLY IDENTIFICATION

PLEASE READ BEFORE ASSEMBLING!

Tip #1: Make sure you've taken all the pieces and hardware out of its packaging before discarding the box.

Tip #2: Using page 2 and/or page 3 of instruction manual make sure all pieces and hardware are accounted for.

Tip #3: Read manual before assembling, it helps!

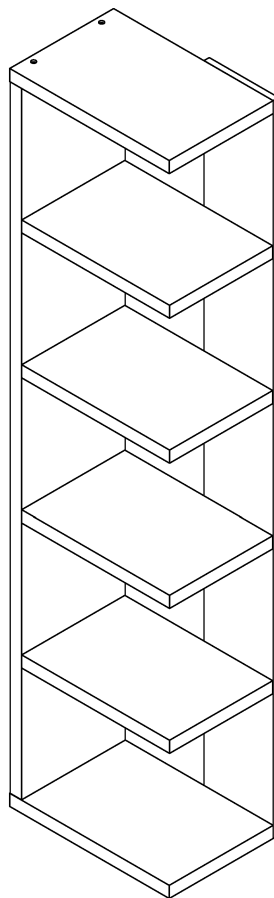



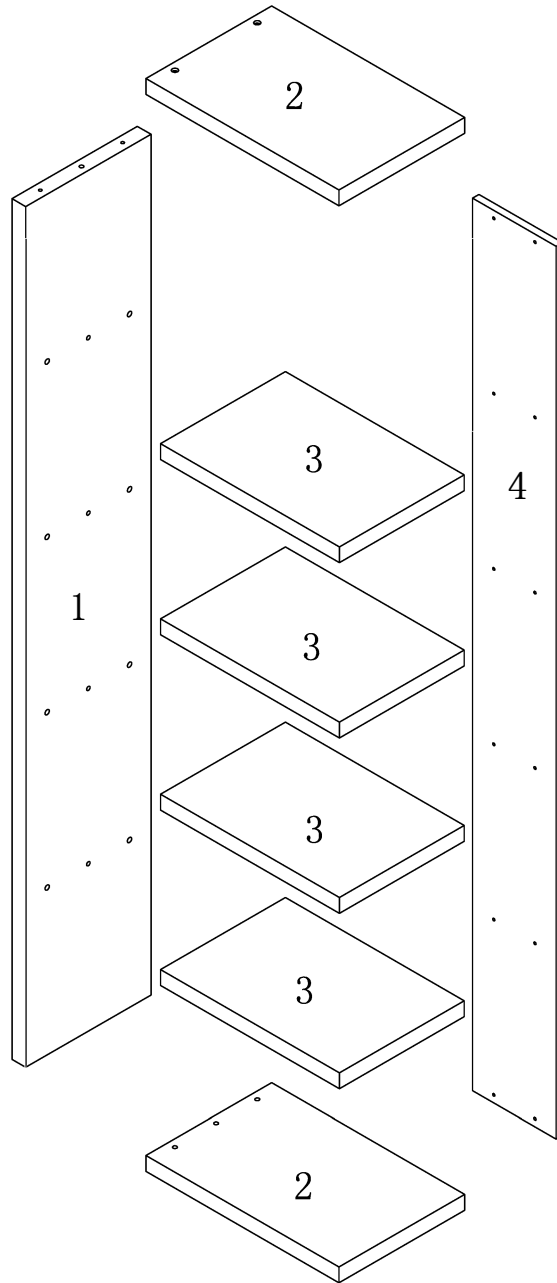

PARTS IDENTIFICATION

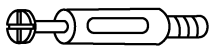

- | | |
|-----|------|
| (1) | 1pc |
| (2) | 2pcs |
| (3) | 4pcs |
| (4) | 1pc |

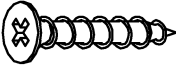
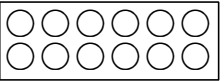
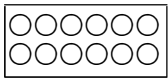
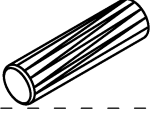
HARDWARE IDENTIFICATION

A		$\phi 7 \times 58$	4pcs
B		L29	8pcs
C		$\phi 15$	8pcs
D		$\phi 4 \times 30$	12pcs
E		$\phi 18$	12pcs
F		$\phi 13$	12pcs
G		$\phi 8 \times 25$	6pcs
H		It's used for stick the stopper to the connecting hole firmly	1pc

ASSEMBLY INSTRUCTION

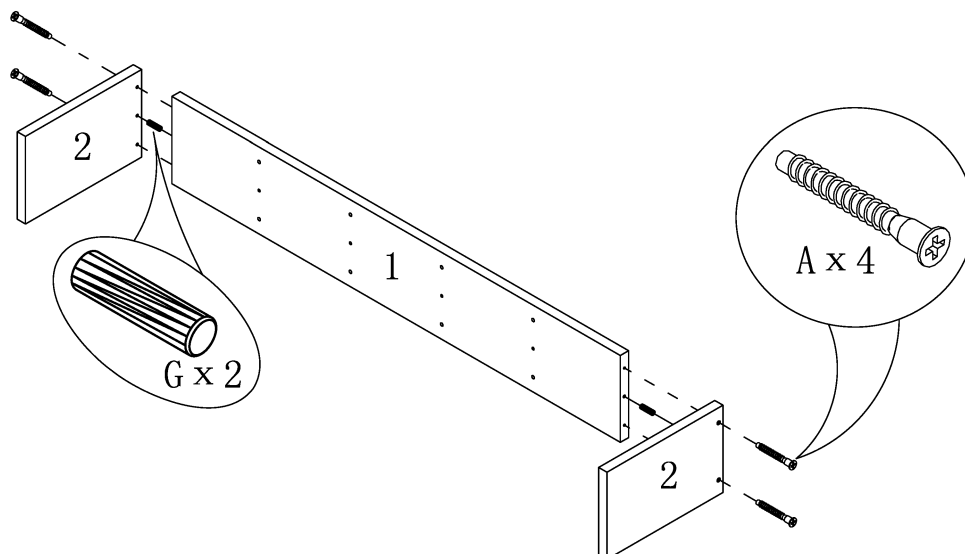

STEP1

PAGE:3 OF 5

ASSEMBLY INSTRUCTION

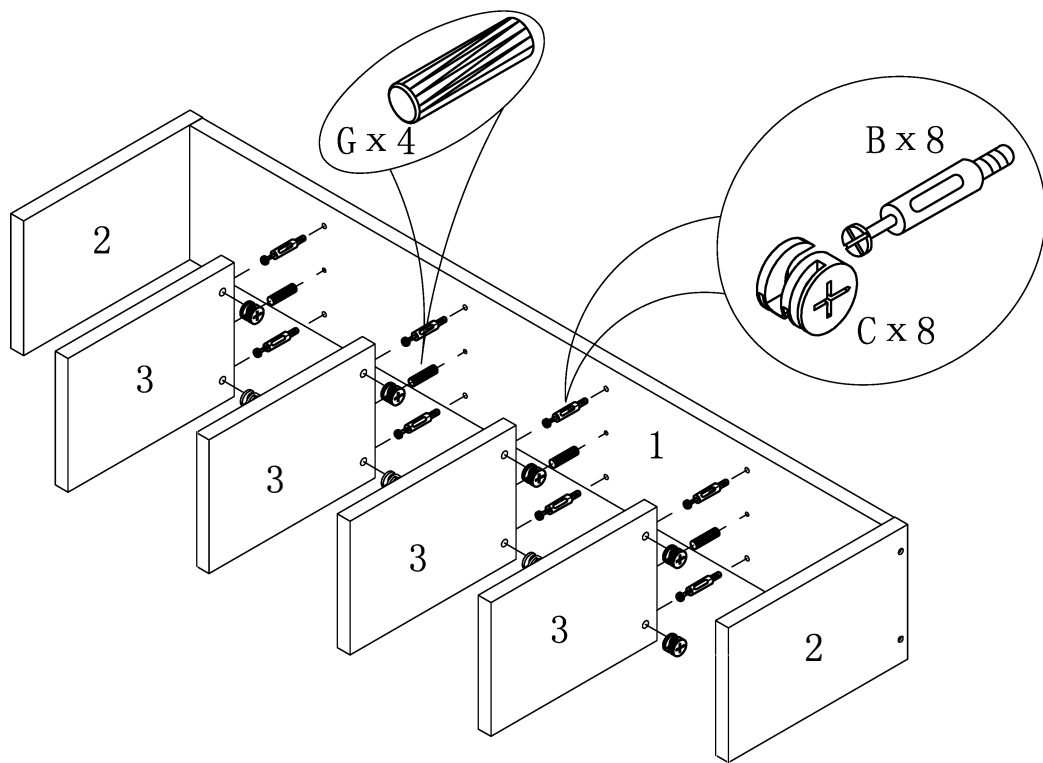

STEP2

STEP3

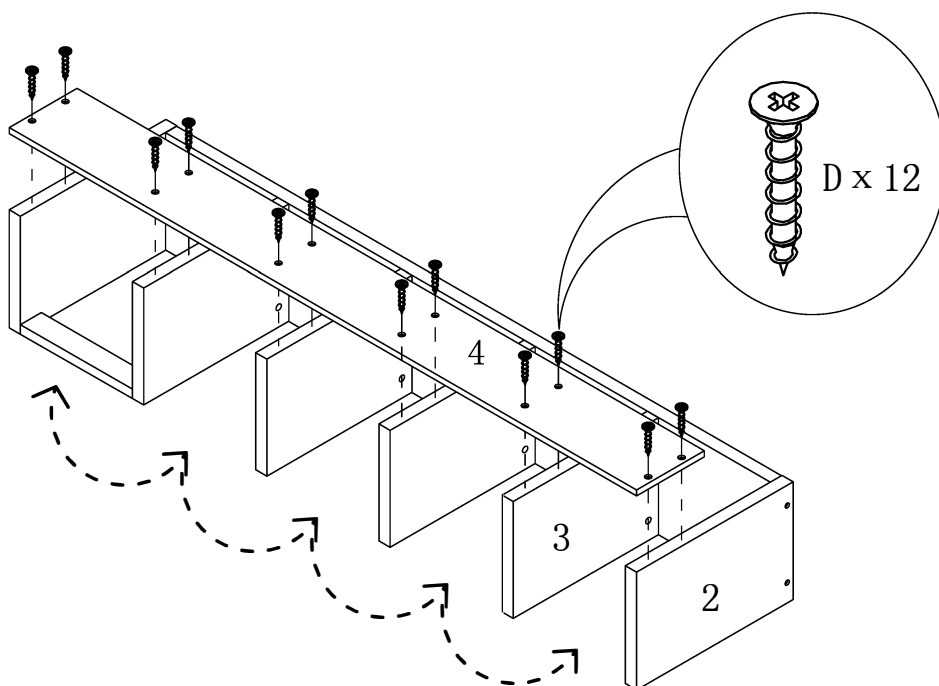

ASSEMBLY INSTRUCTION

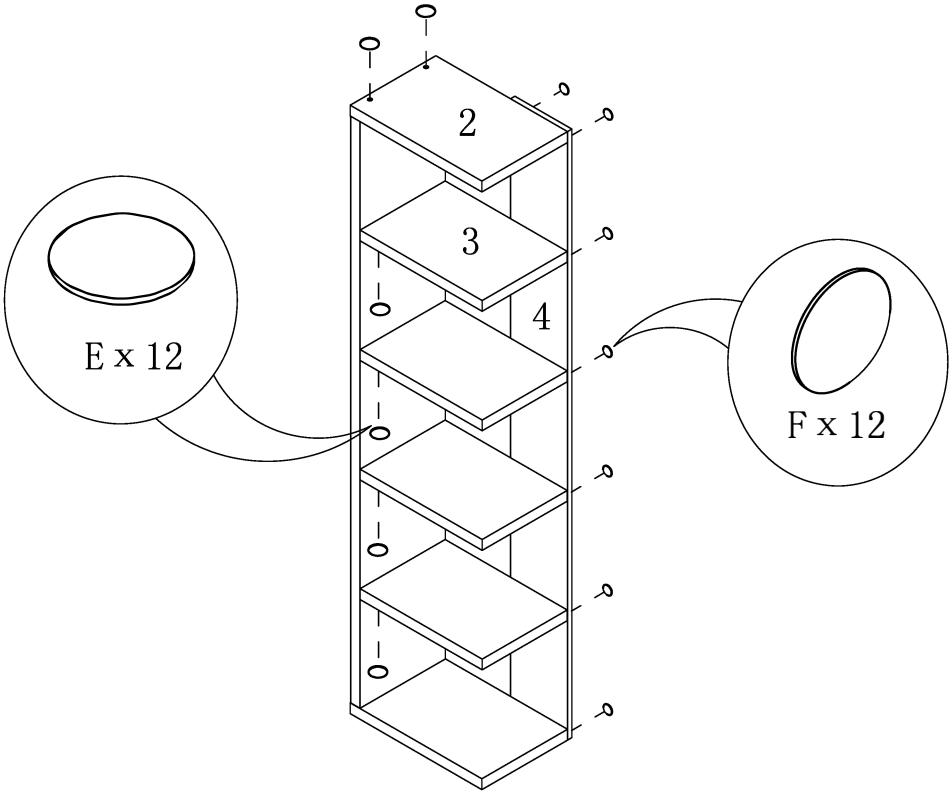

STEP4

STEP5

