











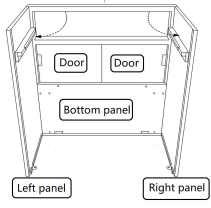
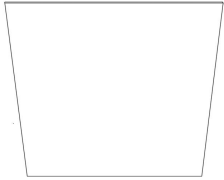



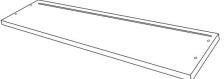
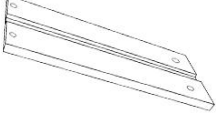
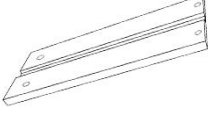
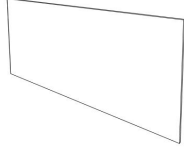

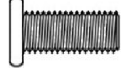

Assembly Instruction

⚠ WARNING:

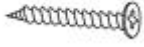
- Read all instructions carefully and completely before assembly and use.
- Retain for future reference.
- DO NOT use power tools.
- DO NOT over-tighten hardware.
- Periodically check all hardware and re-tighten as necessary.
- DO NOT use product if any component becomes damaged.
- For residential (non-commercial) use only.
- DO NOT sit or stand on product. Use only for intended purpose.
- DO NOT exceed 80lbs for the tabletop and 30lbs for the shelf, and 10 lbs for the drawer, evenly distributed.

Parts List

Check all parts before assembly

<p>A. <u>Boby</u></p>  <p>*1</p>	<p>B. <u>Back panel</u></p>  <p>*1</p>	<p>C. <u>Tabletop</u></p>  <p>*1</p>	<p>D. <u>Shelf</u></p>  <p>*1</p>
<p>E. <u>Leg</u></p>  <p>*2</p>	<p>F. <u>Drawer front</u></p>  <p>*1</p>	<p>G. <u>Drawer left panel</u></p>  <p>*1</p>	<p>H. <u>Drawer right panel</u></p>  <p>*1</p>
<p>I. <u>Drawer bottom</u></p>  <p>*1</p>	<p>J. <u>Drawer back panel</u></p>  <p>*1</p>	<p>H1. <u>Hex bolt(6x25mm)</u></p>  <p>*4 (+1 extra)</p>	<p>H2. <u>Washer</u></p>  <p>*4 (+1 extra)</p>
<p>H3. <u>Hex bolt(6x30mm)</u></p>  <p>*14 (+2 extra)</p>	<p>H4. <u>Screw(short)</u></p>  <p>*1 (+1 extra)</p>	<p>H5. <u>Bolt</u></p>  <p>*4 (+1 extra)</p>	<p>H6. <u>Screw</u></p>  <p>*4(+1 extra)</p>
<p>H7. <u>Screw(Long)</u></p>  <p>*4 (+1 extra)</p>	<p>H8. <u>Foot pad</u></p>  <p>*4</p>	<p>H9. <u>Shelf pin</u></p>  <p>*4</p>	<p>H10. <u>Allen Key</u></p>  <p>*1</p>
<p>H11. <u>Spanner</u></p>  <p>*1</p>	<p>H12. <u>Drawer stop</u></p>  <p>*2</p>		

Step 1: Unfold the left panel and right panel and bottom panel from Body (A) as below.

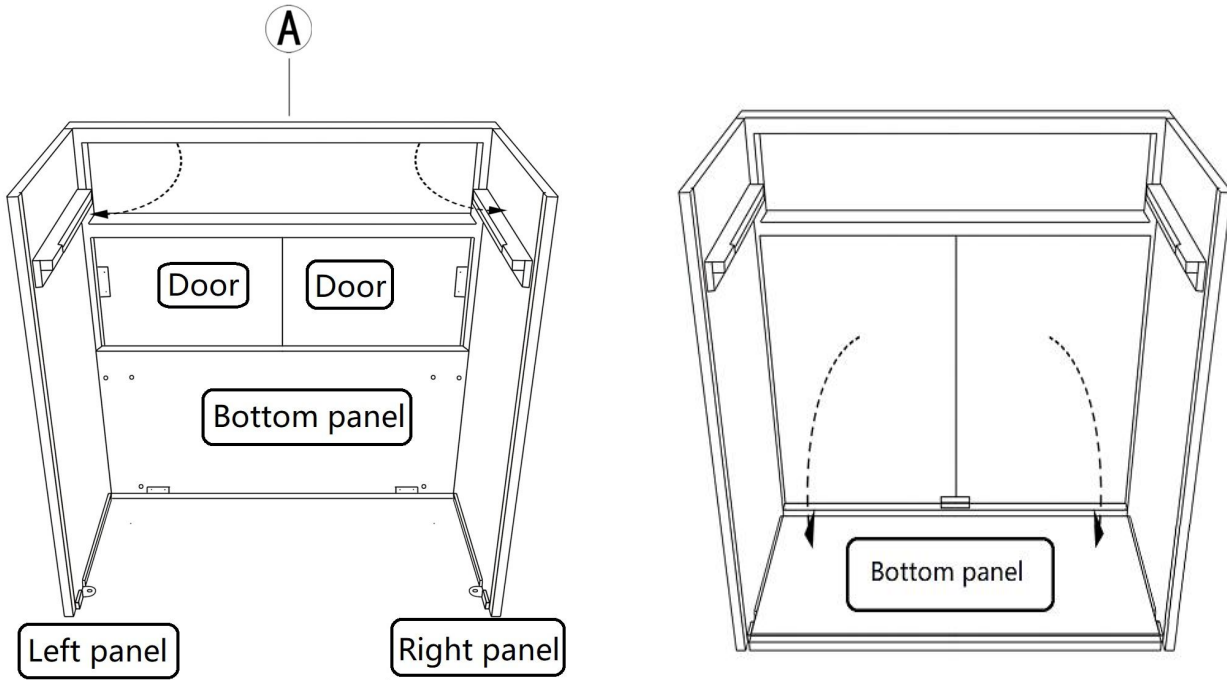

Step 2: Insert Back panel (B) as shown in picture below. Ensure the Back panel (B) with the groove on Left&Right panel (A).

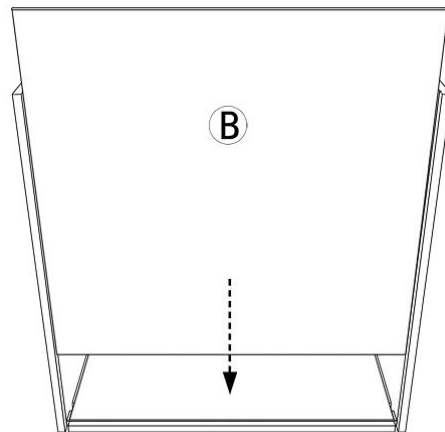

Step 3: Attach the Tabletop (C) to the Body (A) with Hex bolts (H1) and Washers (H2) by Allen key (H10) as shown in picture below. Do not fully tighten the Bolts.

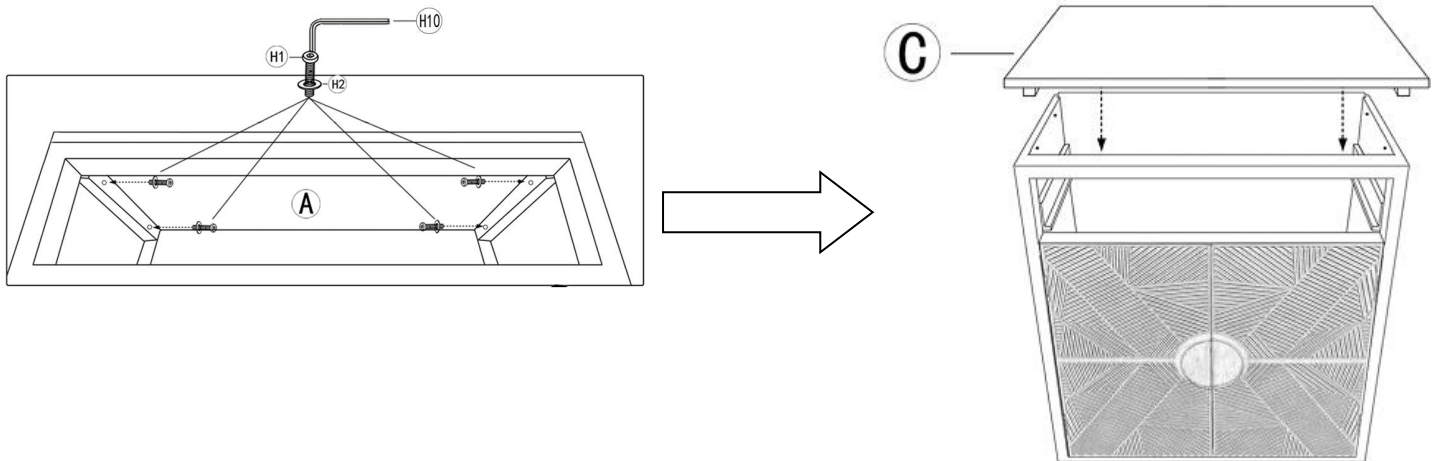

Step 4: Screw the Hex bolts (H3) into the Bottom Panel of the Body (A) By Allen Key (H10).

Attach the Legs (E) to the Bottom Panel of the Body (A) with Hex bolts (H3) By Allen Key (H10). And insert the Foot pads (H8) to the Leg (E). **Fully tighten all Bolts from Step 1 to 4.**

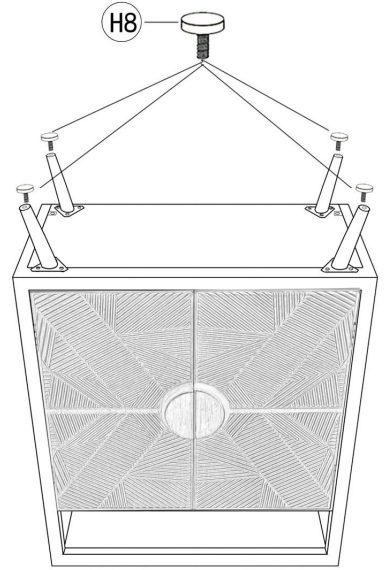
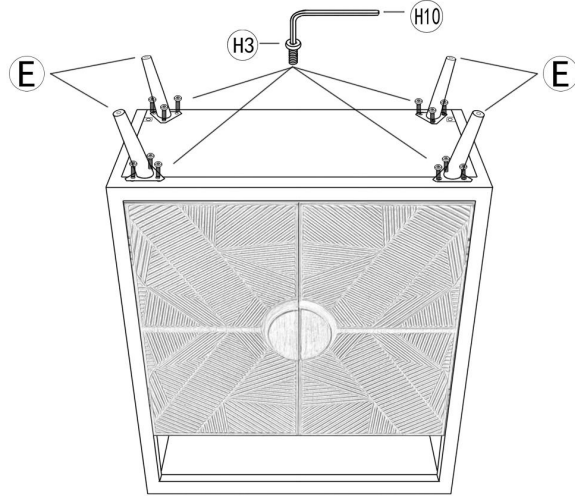
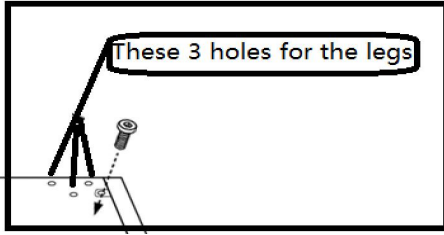

Step 5: Place the Drawer front (F) on soft surface to protect the finish.

1. Attached the Drawer left&right panel (G&H) on the Drawer front (F) with Bolt (H5)&screw(H6) by Spanner (H11) as below shown.

2. Insert the Drawer bottom panel (I) to the left&right panel (G&H) as shown.

3. Attached the Drawer Back Panel (J) with Screw (H7) by Spanner (H11) as below.

4. Attached the Drawer stop (H12) on the Drawer back panel(J) with Screw(H4) by Spanner (H11) as below.

Place the Drawer into the Body (A) as below.

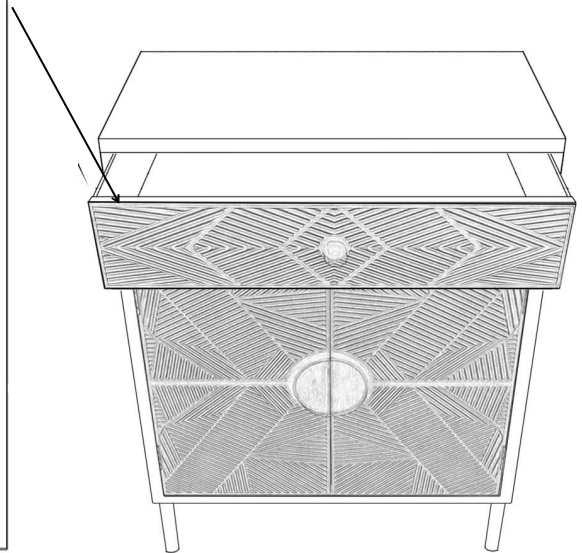
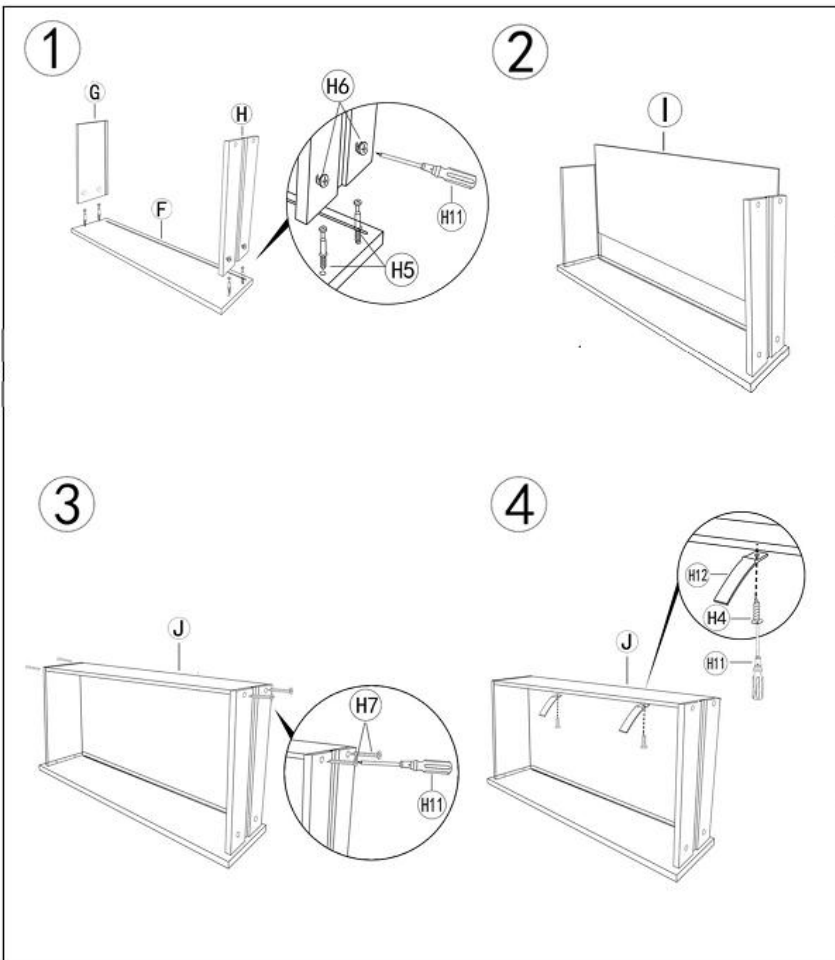

Step 6: Open the doors, Insert the metal pins (H9) on left&Right panel as below left photo shows.

Place the Shelf (D) inside as shown in picture below.

Please note there is having 4 more extra holes on the Left&Right panel, so you can adjust the height of the shelf if needed.

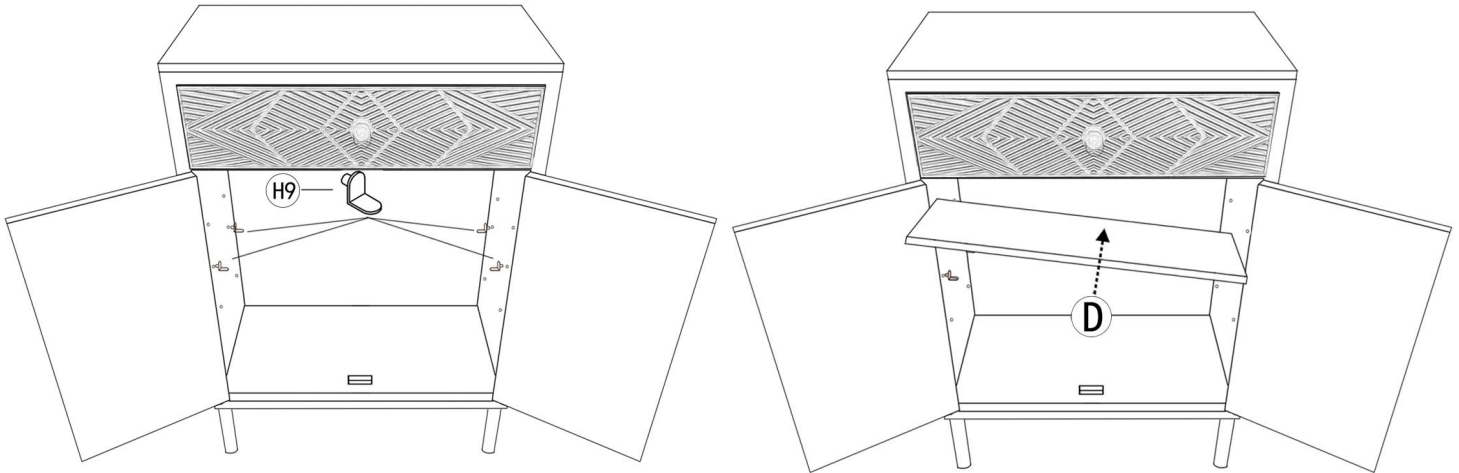

Fully tighten all bolts. Assembly finished.

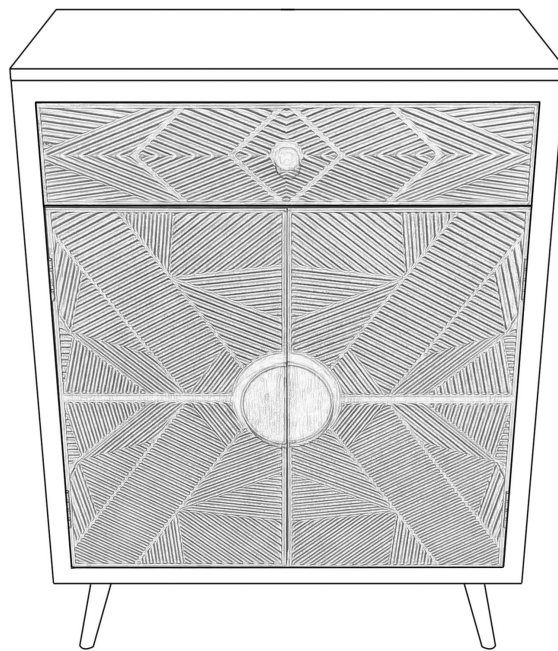

Notice:

If you have any questions about your purchase or any other product for sale, please contact Service@jimsidea.com with your order ID, our customer service representatives are available to help.