

3 DOOR CABINET











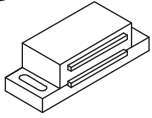

ASSEMBLY INSTRUCTIONS

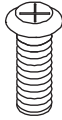
We have designed our furniture with you , the customer in mind . Our clear , easy to follow , step by step instructions will guide you through the project from start to finish . Feel confident that this will be a fun and rewarding project . The final product will be a quality piece of furniture that will go together smoothly and give years of enjoyment .



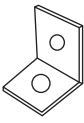

Please do not return to the store
Broken or missing parts?
Need help with assembly?

Hardware List

A 	B 	C 	D 
Magnet (3pcs)	Magnet screw (6pcs)	Knob (3pcs)	Knob screw (3pcs)
E 	F 	G 	H 
Spring pins (6pcs)	Plastic anchor (1pc)	Screw (20pcs)	Cable tie (1pc)
I 	J 	K 	L 
Eyelet screw (1pc)	Short screw (1pc)	Bracket (1pc)	Cap (20pcs)

Panel List

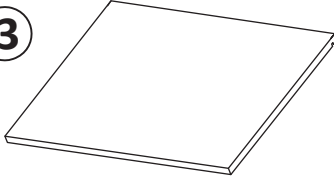
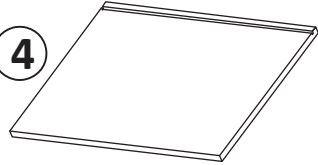
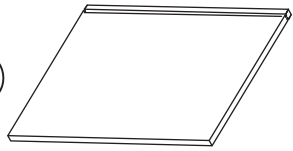
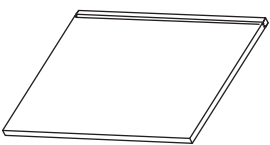
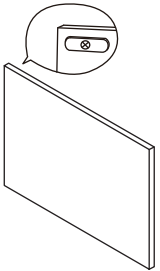
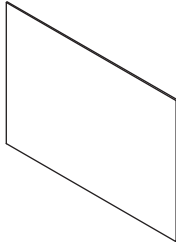
1  Left side panel (1pc)	2  Right side panel (1pc)	
3  Top panel (1pc)	4  Bottom panel (1pc)	5  Second-shelf panel (1pc)
6  Third&Fourth-shelf panel (2pcs)	7  Door panel (3pcs)	8  Back panel (4pcs)

Exploded Views

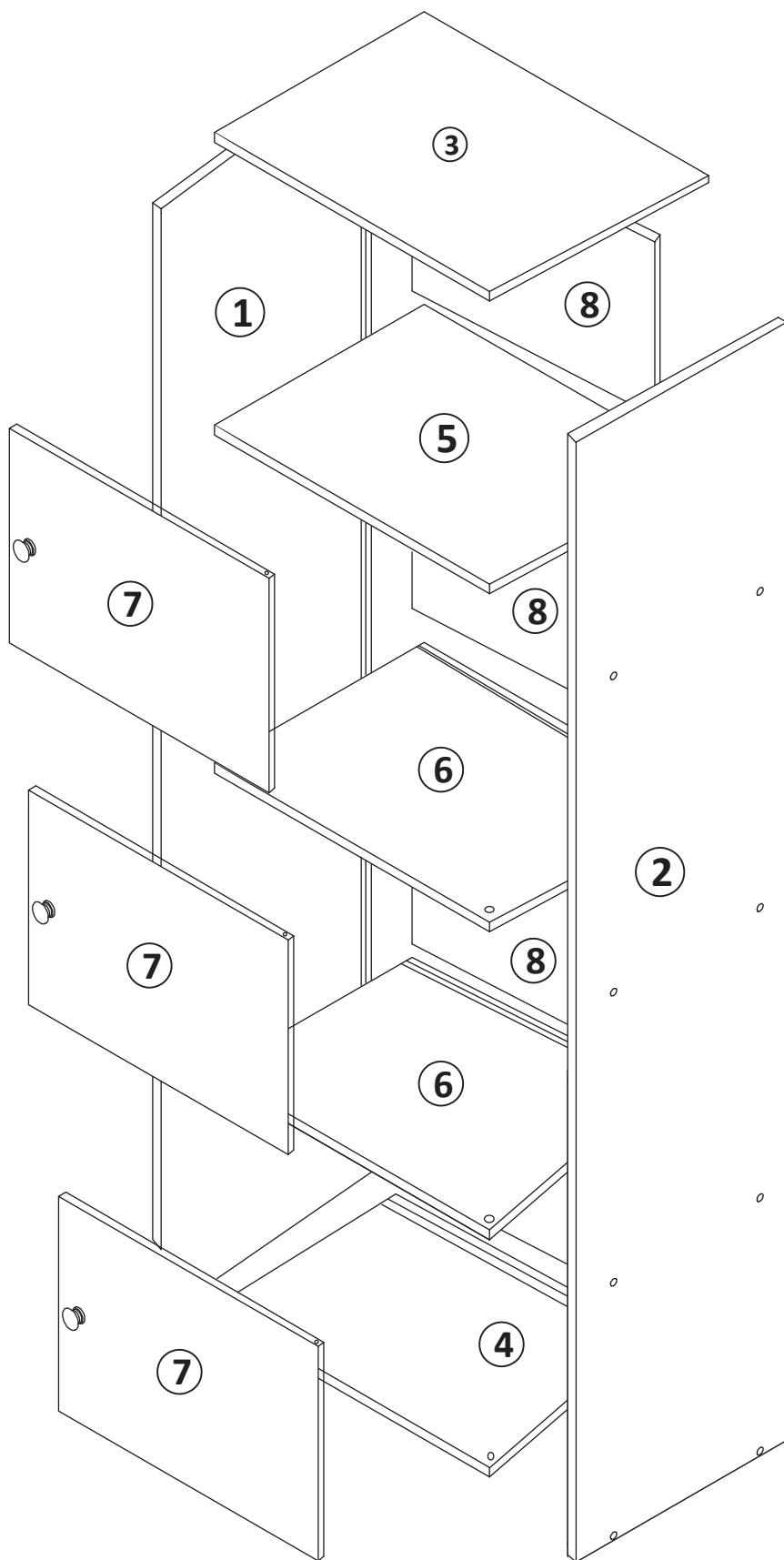

Step 1

1. Attach magnets (A) to the second - shelf panel (5) and third & fourth-shelf panels (6) with magnet screws (B).
2. Attach knobs (C) to doors (7) using knob screws (D).
3. Insert spring pins (E) into doors (7) as shown.

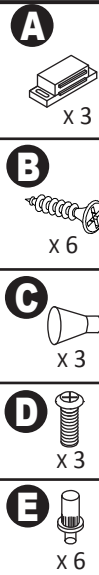
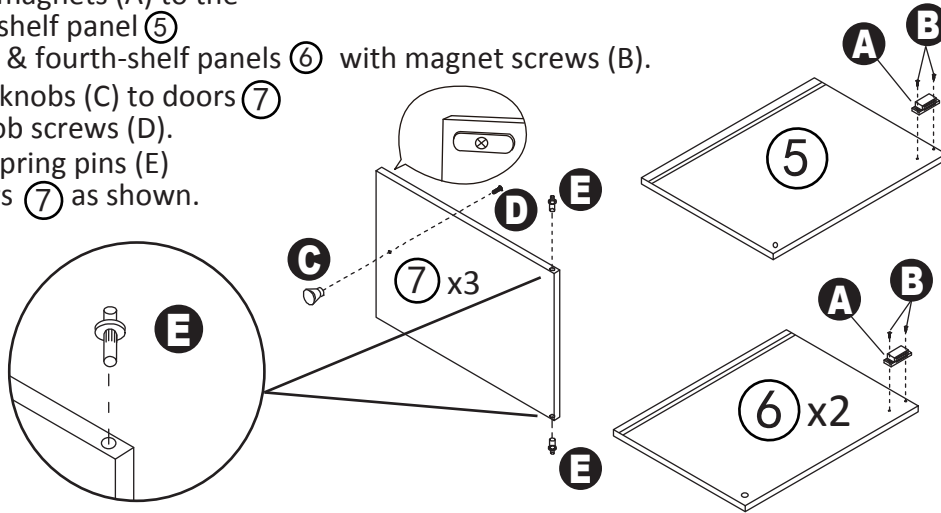

Step 2

1. Connect top panel (3), second -shelf panel (5), third & fourth-shelf panels (6) and bottom panel (4) to left side panel (1) with screws (G).
2. Slide back panels (8) into the grooves of the unit.

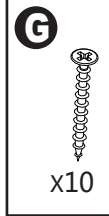
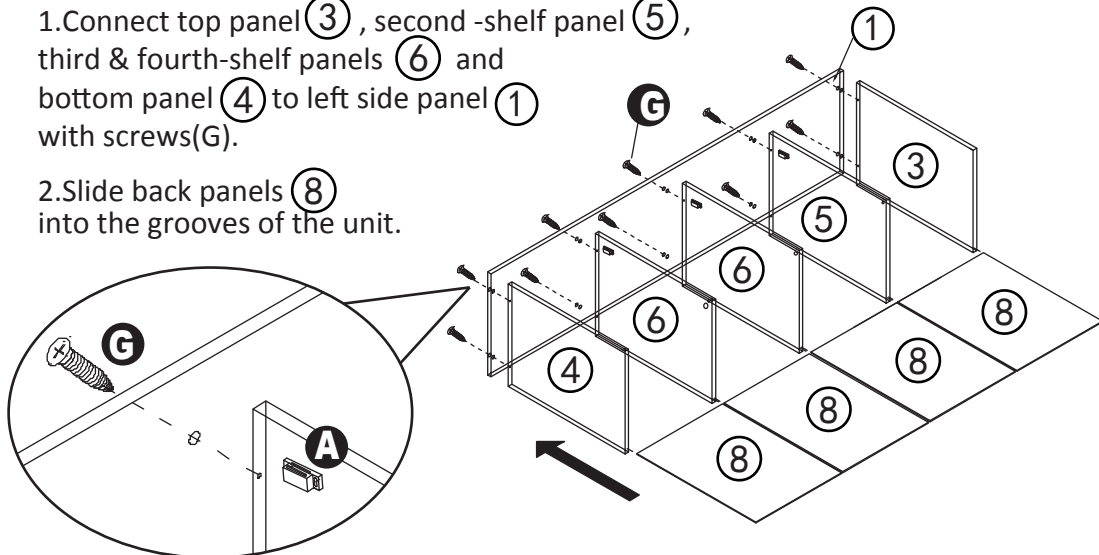

Step 3

1. Connect right side panel (2) to unit with screws (G).

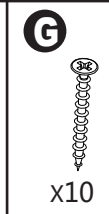
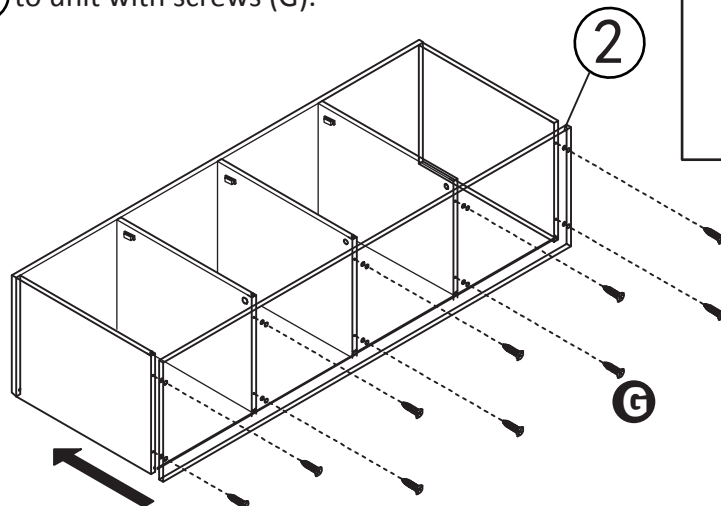

Step 4

1. Insert doors (7) into unit by placing one end of spring pins (E) into holes, gently compress other spring pins (E) so that it will slide into remaining holes.

TO ATTACH DOORS

Push door spring pins (E) down. Align with pre-drilled hole in unit. Release.

Push

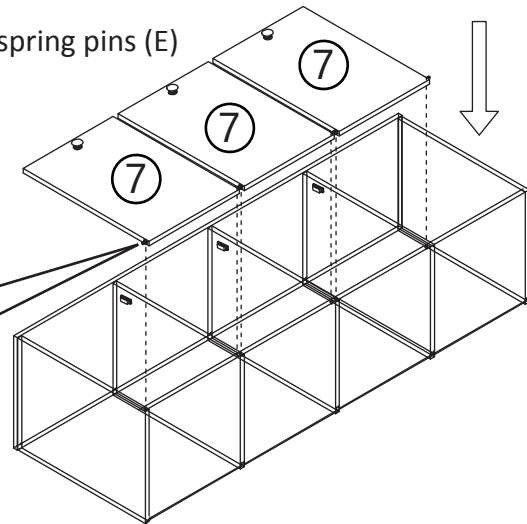
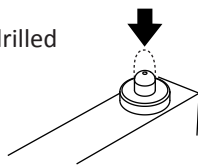

Step 5

1. Cover the screw holes with caps (L).

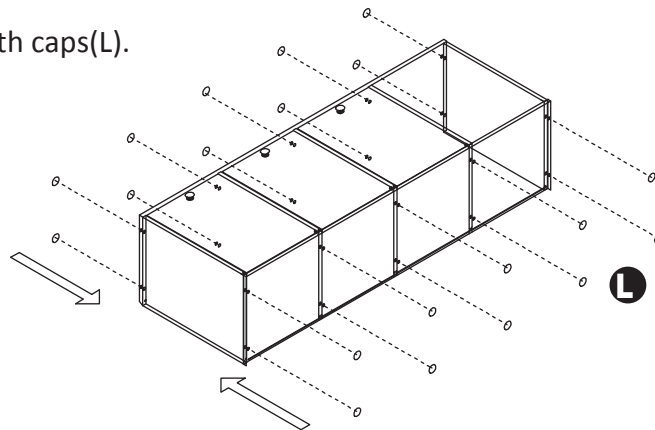

L



x 20

Step 6

1. Connect bracket (K) to unit as shown using short screw (J).
2. Drill hole slightly smaller than plastic anchor (F) into drywall and gently tap plastic anchor into hole.
3. Insert eyelet screw (I) into plastic anchor (F) and fasten unit to wall using cable tie (A).

