

# ASSEMBLY AND INSTALLATION INSTRUCTIONS

**WARNING: BE SURE TO SHUT OFF POWER AT THE MAIN FUSE OR CIRCUIT BREAKER BOX BEFORE INSTALLING OR SERVICING THIS FIXTURE.**

**NOTE: 1. Before installing, consult local electrical codes for wiring and grounding requirements.  
2. READ AND SAVE THESE INSTRUCTIONS.**

## Hardware Package (included):

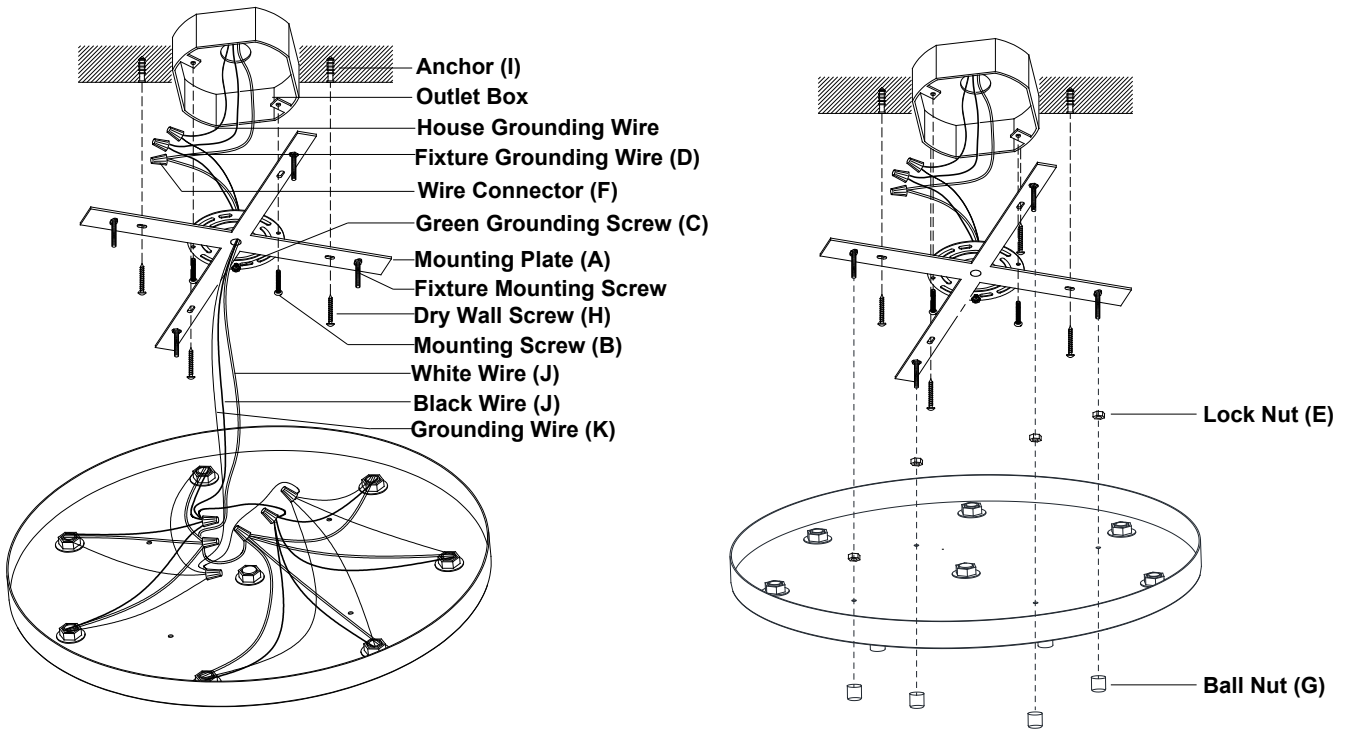
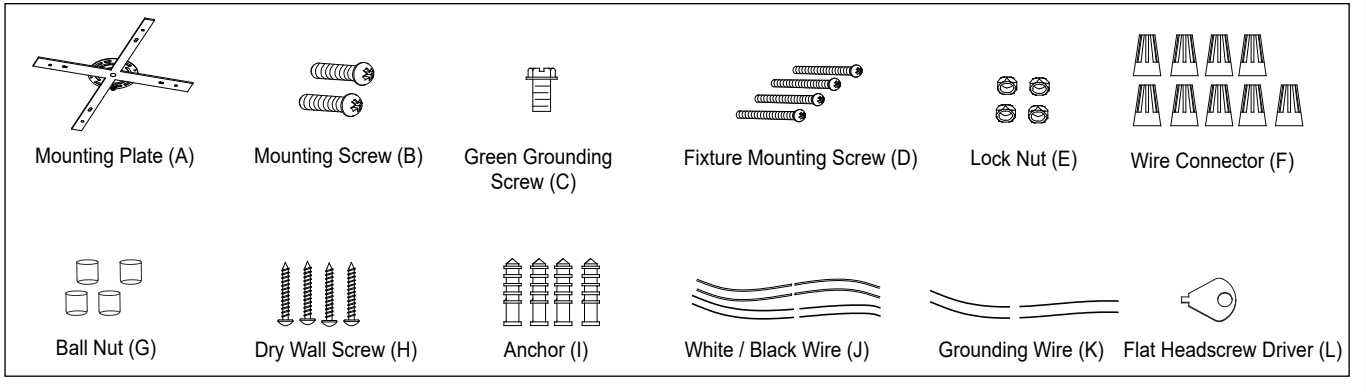

Figure.1

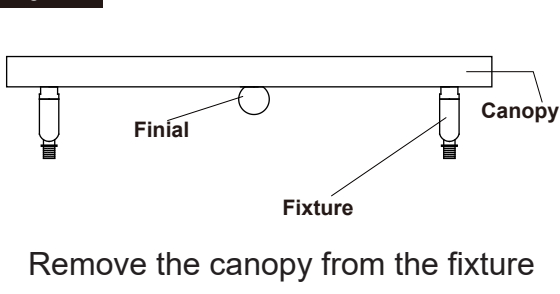
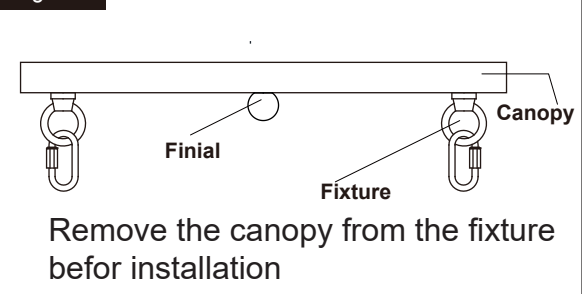
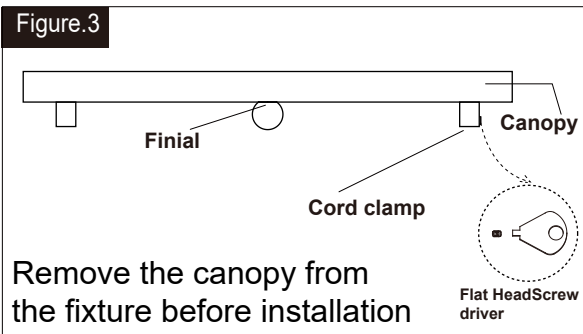

Figure.2





## Installation Steps

Turn off the power at fuse or circuit box.

1. Carefully unpack the fixture, lay out the fixture on a clean surface.

2. Attach the mounting plate by using mounting screw to the outlet box, and secure it to the ceiling with dry wall screws and anchors.

3. Attach the fixture mounting screws and lock nuts to the mounting plate, then secure it with ball nuts.

4. **Install the Fixture** (the Fixture is sold separately).

a. Remove the canopy from the fixture before installation (See Figure 1~3.)

b. **Side fixture** : Thread the fixture wire through the canopy as showed, and then secure the fixture to the canopy with metal pad, washer and hex nut.

5. Cut any excess fixture wires leaving only about 8" (20cm) length from the top end of nipple, then strip off 3/4" the fixture wires of plastic from each end.

6. Pull out the outlet wires and house grounding wire from the outlet box. Make wire connections using the wire connector.

---All black wires from rods to the black wire from power source.

---All white wires from rods to the white wire from power source.

---Attach the grounding wire to the mounting plate with the green grounding screw. Then connect it to the house grounding wire and all grounding wires from the frame with a wire connector.

Carefully put the wires back into the outlet box.

7. Attach the canopy to the mounting plate by inserting the coupling, then secure it with the finial .

8. **Angled mounting recommended for a vaulted or angled ceiling. (See Figure. 4~6)**

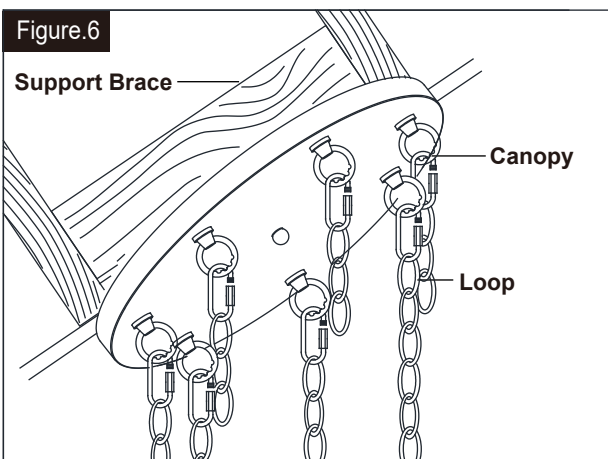
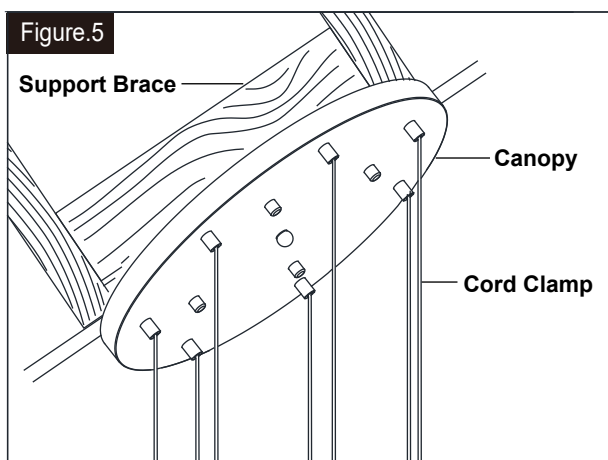
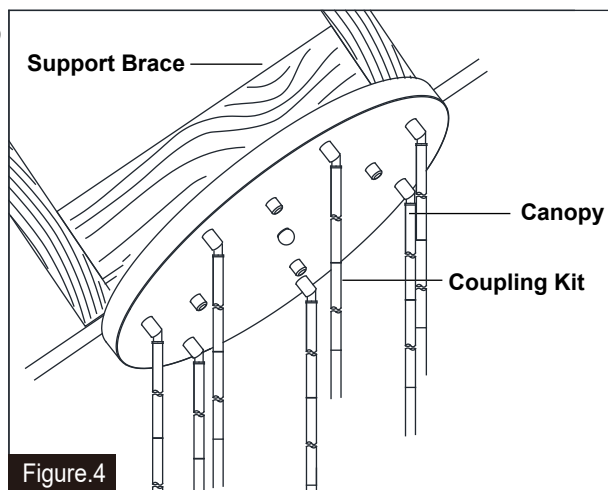

Turn on the power at fuse or circuit box.

The following parts are available for re-order if damaged or missing.

**Spare Parts List:**

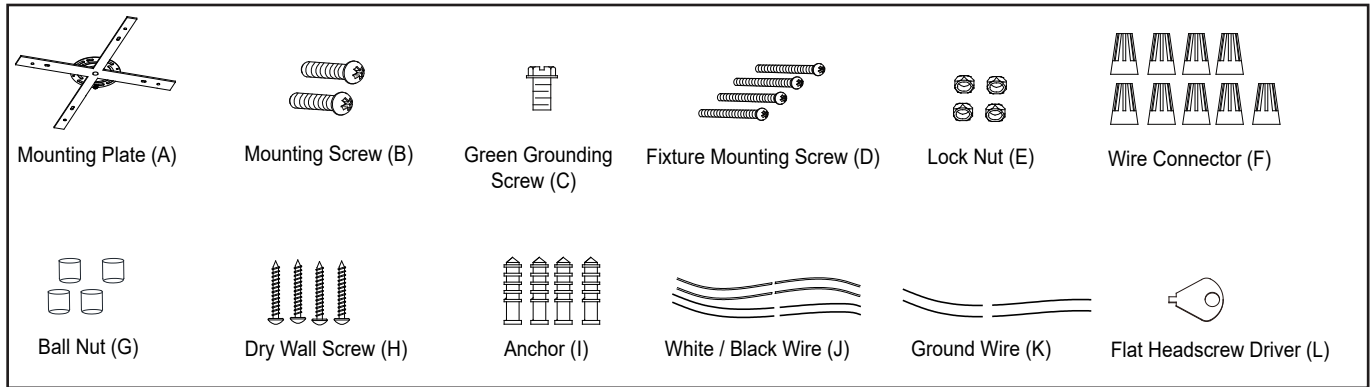

↓  
Assembly Kit

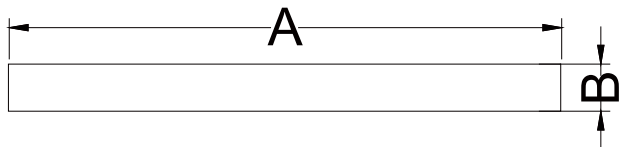

A: 19-5/8"  
B: 1"