

ASSEMBLY INSTRUCTIONS



Fine Furniture for every stage of life

Serving Cart

ASSEMBLY INSTRUCTIONS

ASSEMBLY TIPS:

- 1.Remove hardware from box and sort by size.
- 2.Please check to see that all hardware and parts are present prior to start of assembly.
- 3.Please follow attached instructions in the same sequence as numbered to assure fast & easy assembly.







Warning !

- 1.Don't attempt to repair or modify parts that are broken or defective. Please contact the store immediately.
- 2.This product is for home use only and not intended for commercial establishment.





ASSEMBLY TIME

25 MINUTES

PARTS IDENTIFICATION

A. Handle		1PC
B. Frame		2PCS
C. Upper Glass		1PC
D. Mirror		1PC
E. Long Tube		4PCS
F. Short Tube		4PCS

HARDWARE IDENTIFICATION

1	Pad Sucker 8mm		8PCS
2	Caster w/Caster Washer 40mm 1-1/4"		4PCS
3	Long Bolt 1/4" x 4"		8PCS
4	Bolt Washer 1-1/4"		12PCS
5	Cap 1-1/4"		2PCS

ASSEMBLY INSTRUCTIONS

STEP 1

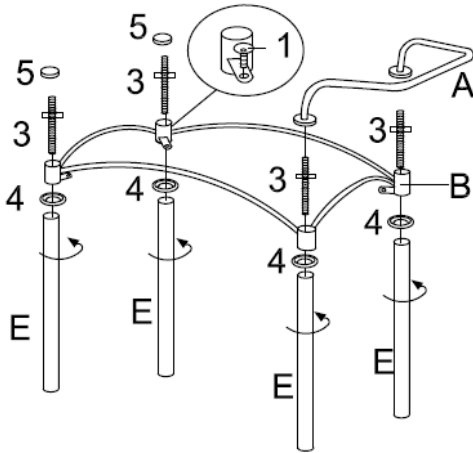

STEP 2

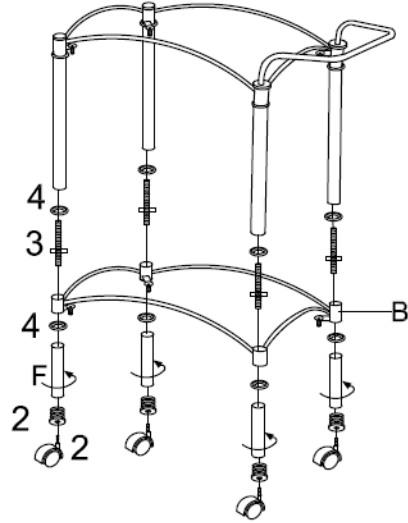

STEP 3

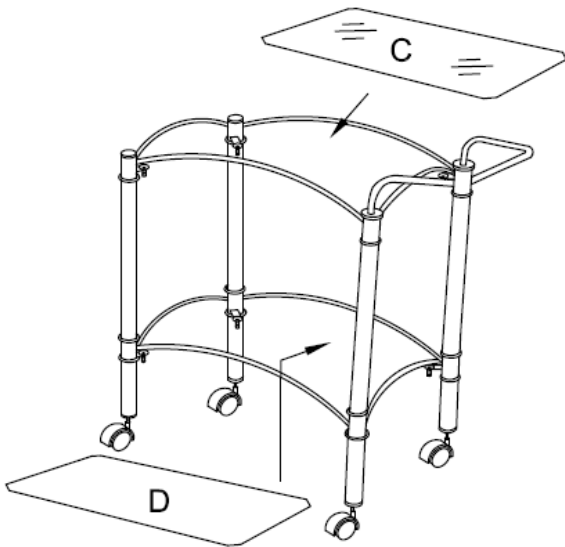

STEP 4 **COMPLETE**

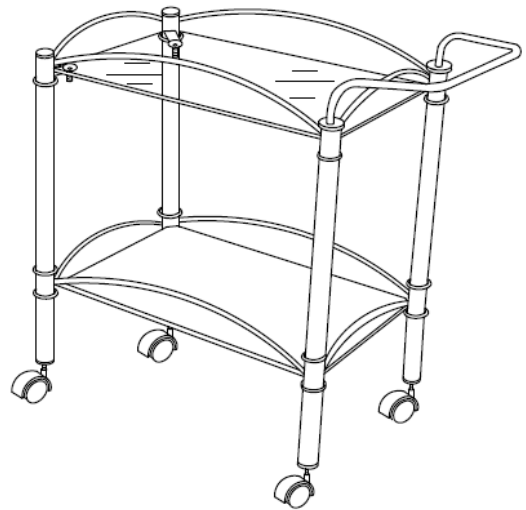



Note : Dimension tolerance $\pm 5\%$