

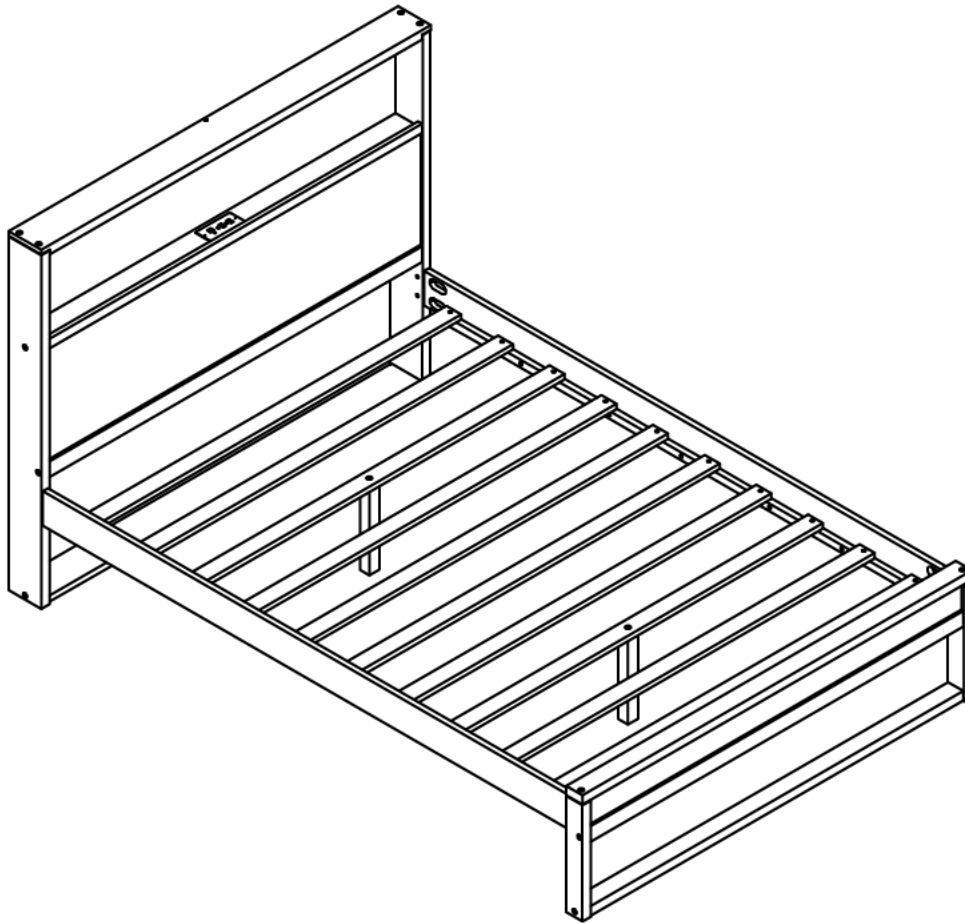

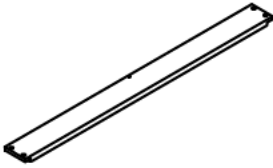









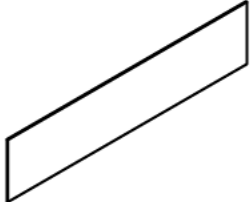
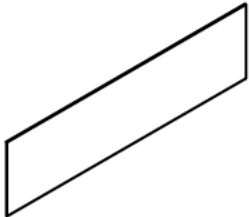

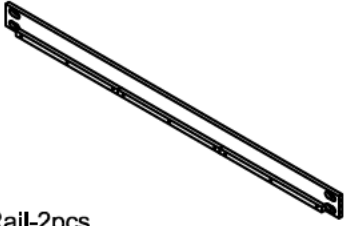
ASSEMBLY INSTRUCTION

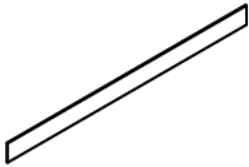

1. Follow the information on the warning label appearing on the upper bunk end structure and on the carton... Do not remove warning label from bed.
2. Always use the recommended size mattress or mattress support, or both, to help prevent the likelihood of entrapment or falls.
3. Surface of mattress must be at least 5 inches below the upper edge of guard rails.
4. Do not allow children under 6 years to use the upper bunk.
5. Prohibit more than one person on upper bunk.
6. Periodically check and ensure that the guardrail, ladder, and other components are in their proper position, free from damage, and that all connectors are tight.
7. Do not allow horseplay on or under the bed and prohibit jumping on the bed.
8. Always use the ladder for entering and leaving upper bunk.
9. Do not use substitute part. Contact the manufacturer or dealer for replacement part.
10. Use of night light may provide added safety precaution for a child using the upper bunk.
11. If the bunk bed will be placed next to a wall, the guardrail that runs the full length of the bed should be placed against the wall to prevent entrapment between the bed and the wall.
12. Always use guardrail on both long sides of the upper bunk.
13. The use of water or sleep flotation mattresses is prohibited.
14. Keep these instruction for future reference.
15. Strangulation Hazard - Never attach or hang items to any part of the bunk bed that are not designed for use with the bed, for example, but not limited to hooks, belts and jump rores.
16. Trundle : Only use for mattress 6 inch.

Part List & Hardware

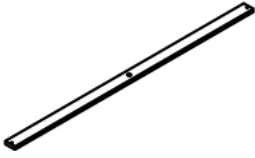
<p>A1</p>  <p>Top Panel-1pc</p>	<p>A2</p>  <p>Leg- 1pc</p>	<p>A3</p>  <p>Leg- 1pc</p>
<p>A4</p>  <p>Panel-1pc</p>	<p>A5</p>  <p>WoodBar-1pc</p>	<p>A6</p>  <p>Panel-1pc</p>
<p>A7</p>  <p>Panel-1pc</p>	<p>A8</p>  <p>WoodBar-2pcs</p>	<p>A9</p>  <p>WoodBar-1pc</p>
<p>B1</p>  <p>Side Rail-2pcs</p>	<p>B2</p>  <p>Leg- 1pc</p>	<p>B3</p>  <p>Leg- 1pc</p>
<p>B4</p>  <p>WoodBar-1pc</p>	<p>B5</p>  <p>Panel-1pc</p>	<p>B6</p>  <p>WoodBar-1pc</p>
<p>B7</p>  <p>WoodBar-2pcs</p>	<p>B8</p>  <p>Slats-8pcs</p>	<p>B9</p>  <p>Slats-2pcs</p>

Hardware List

1



Ø1/4" x 30 mm
Hex-Head bolts 2pcs

2

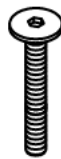

Ø1/4" x 50 mm
Hex-Head bolts 8pcs

3

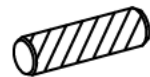

Ø8 x 30 mm
Wood dowel 2pcs

4

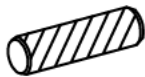

Ø10 x 40 mm
Wood dowel 16pcs

5



M4 x 30 mm
Wood Screws 22pcs

6



8pcs

7



Allen Key 1pc

8



Screws 1/4" x40
4pcs

9



Screws 1/4" x50
10pcs

10



M3 x 15 mm
Wood Screws 2pcs

11

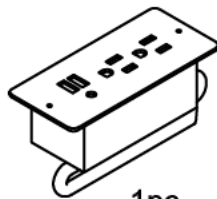

1pc

12



Ø1/4" x 13 mm
Horizontal-Hole bolts 8pcs

13



Screws 1/4" x60
2pcs

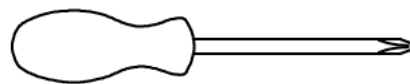

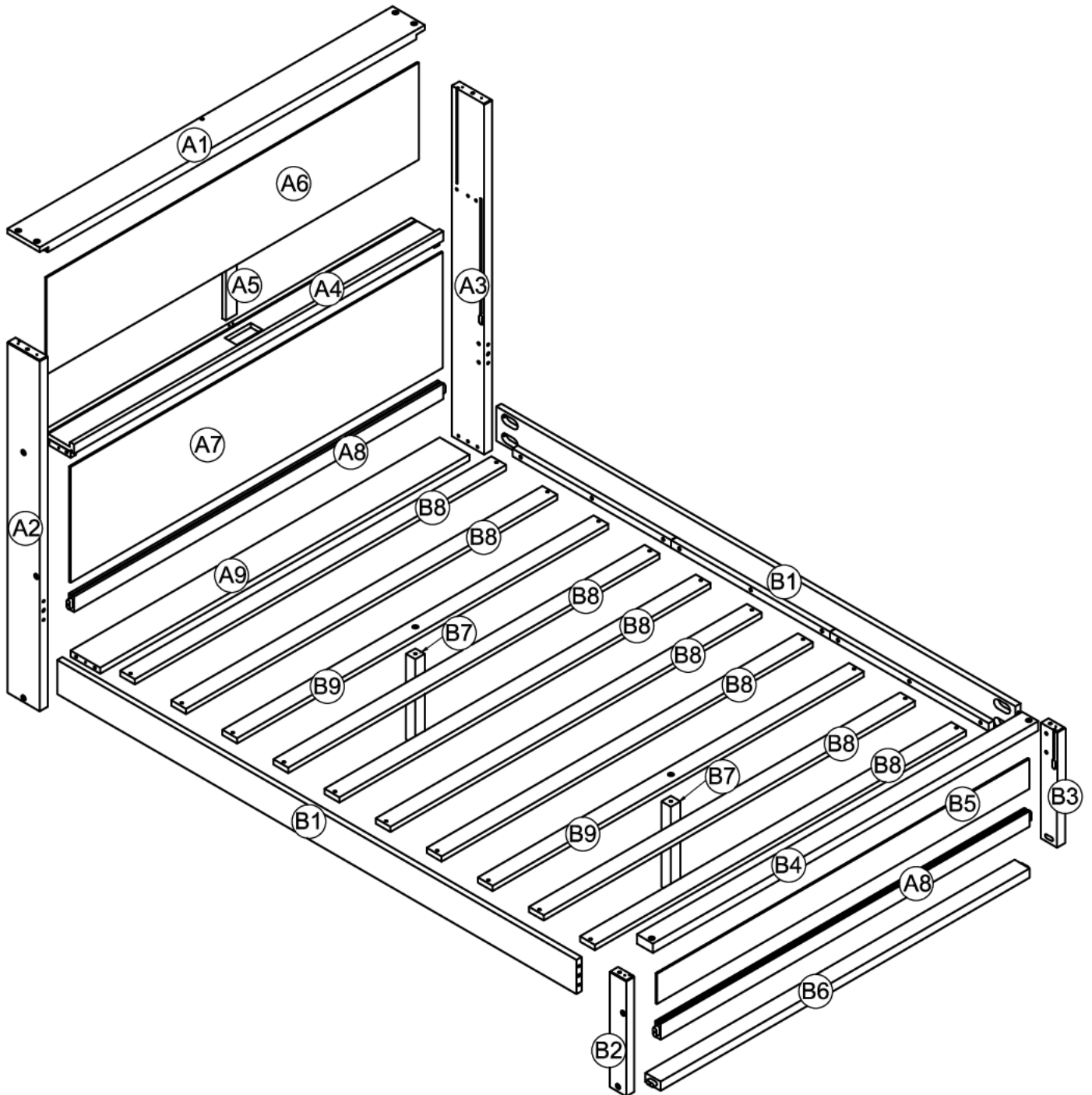

Assembly Tools Required (Not Included)

ASSEMBLY INSTRUCTION





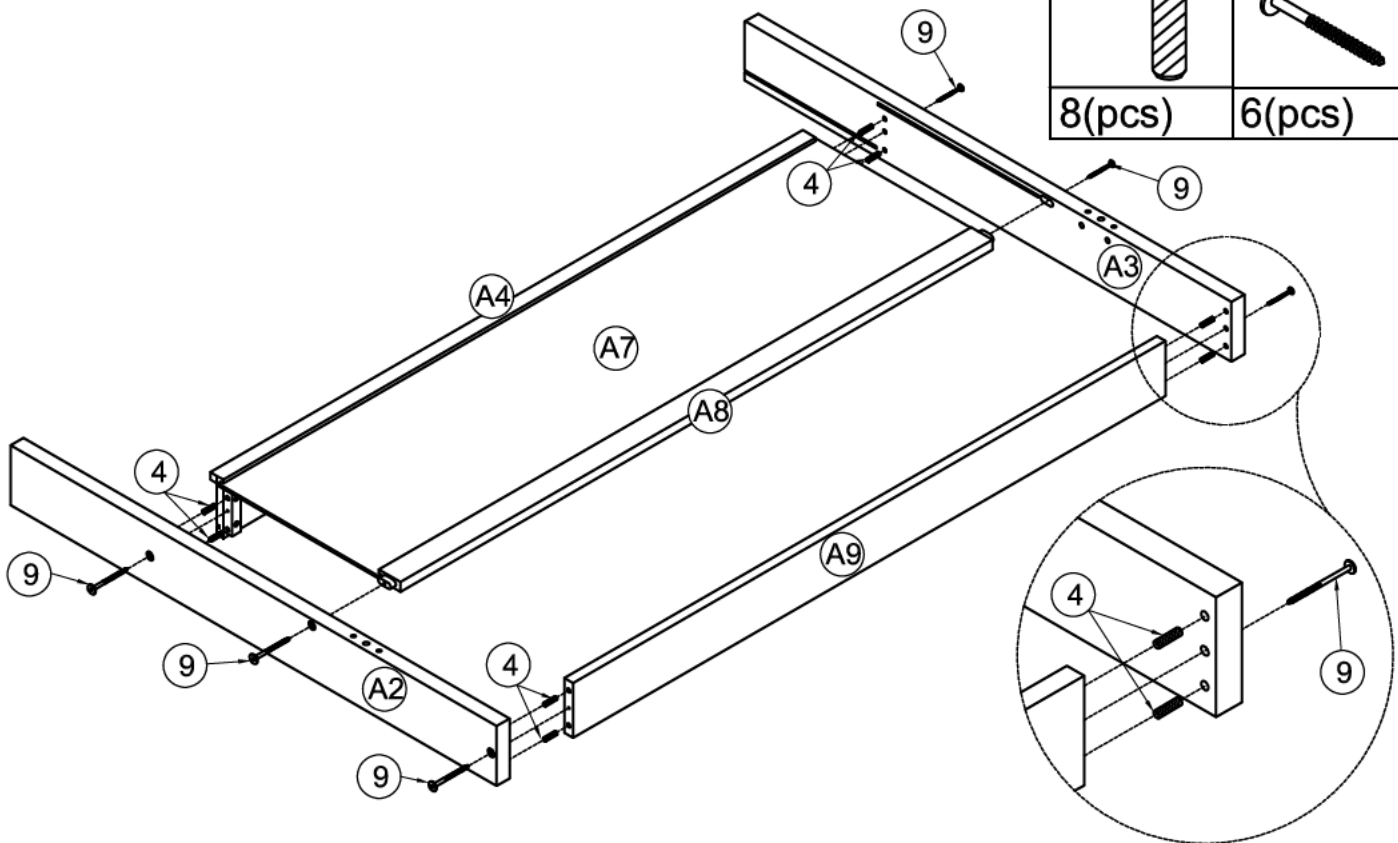

STEP1: Following below illustration.

4		9	
8(pcs)		6(pcs)	

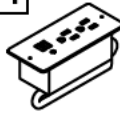

STEP2: Following below illustration.

11		10		5		3		8	
1(pc)		2(pcs)		2(pcs)		2(pcs)		4(pcs)	

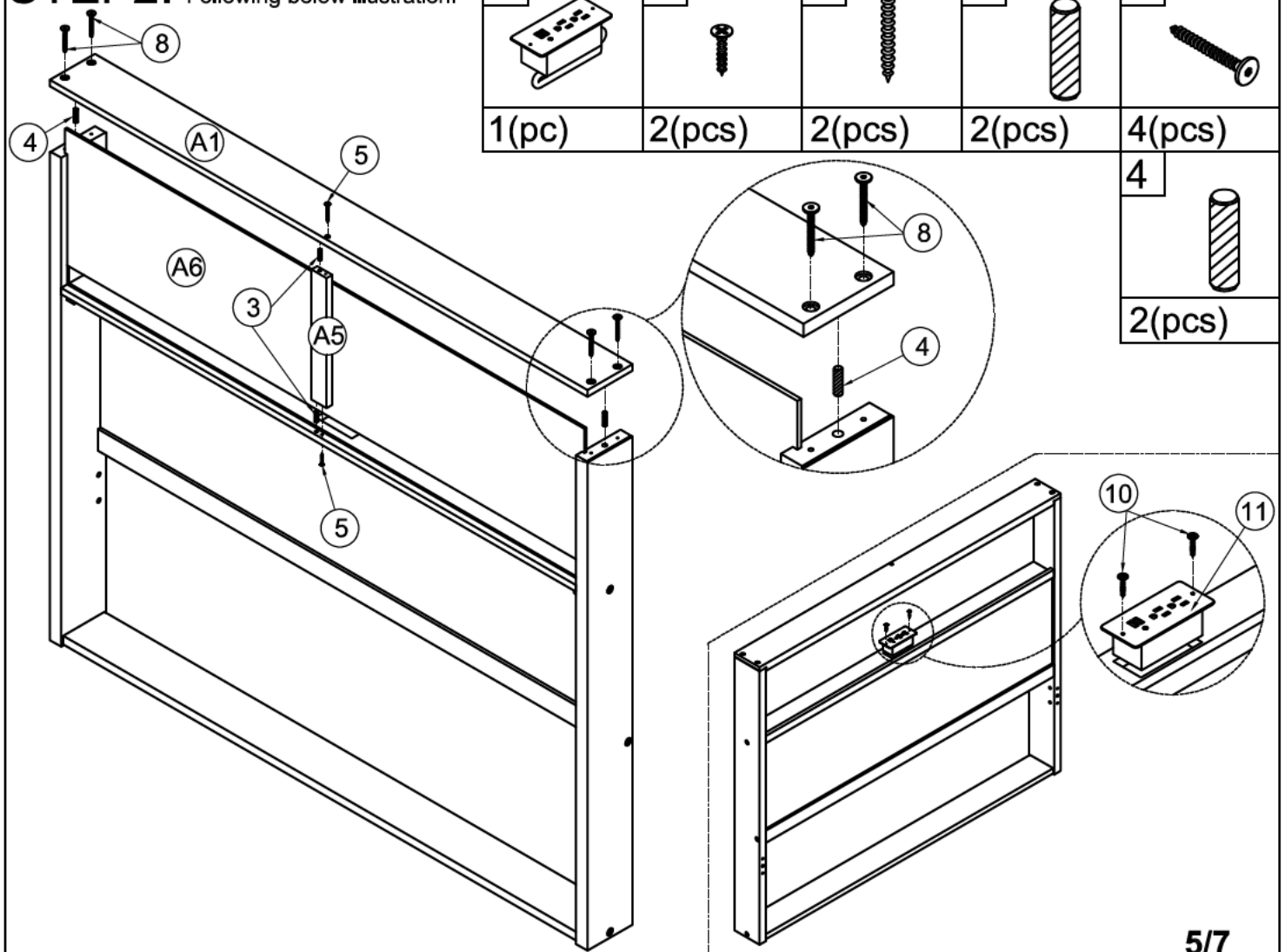



4	
2(pcs)	

STEP3: Following below illustration.

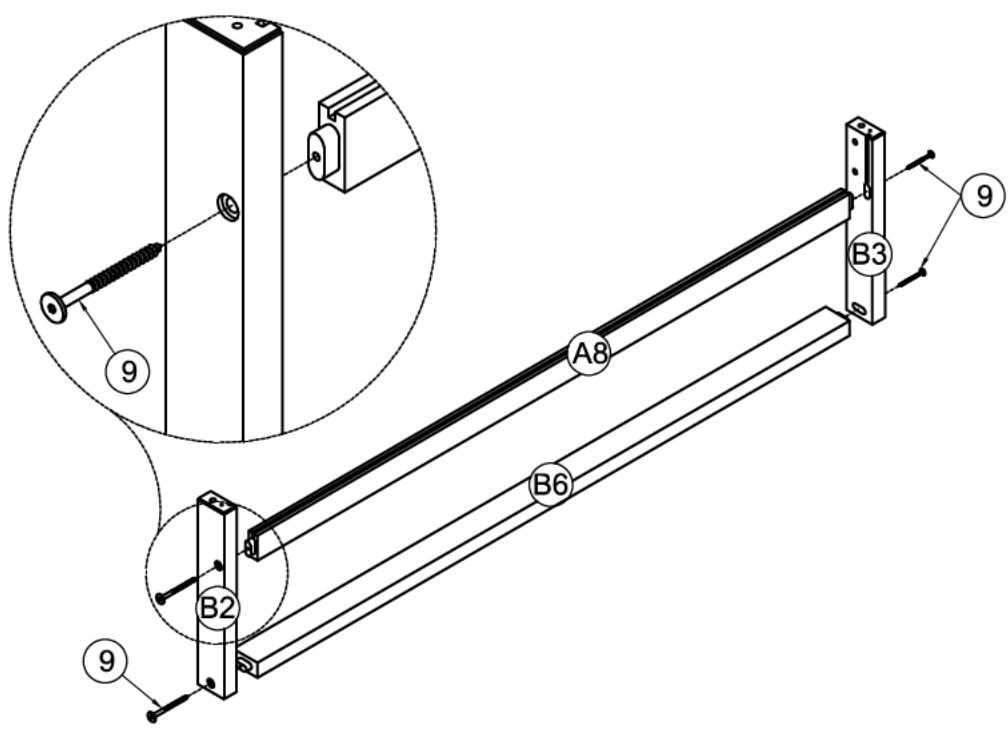
9

4(pcs)



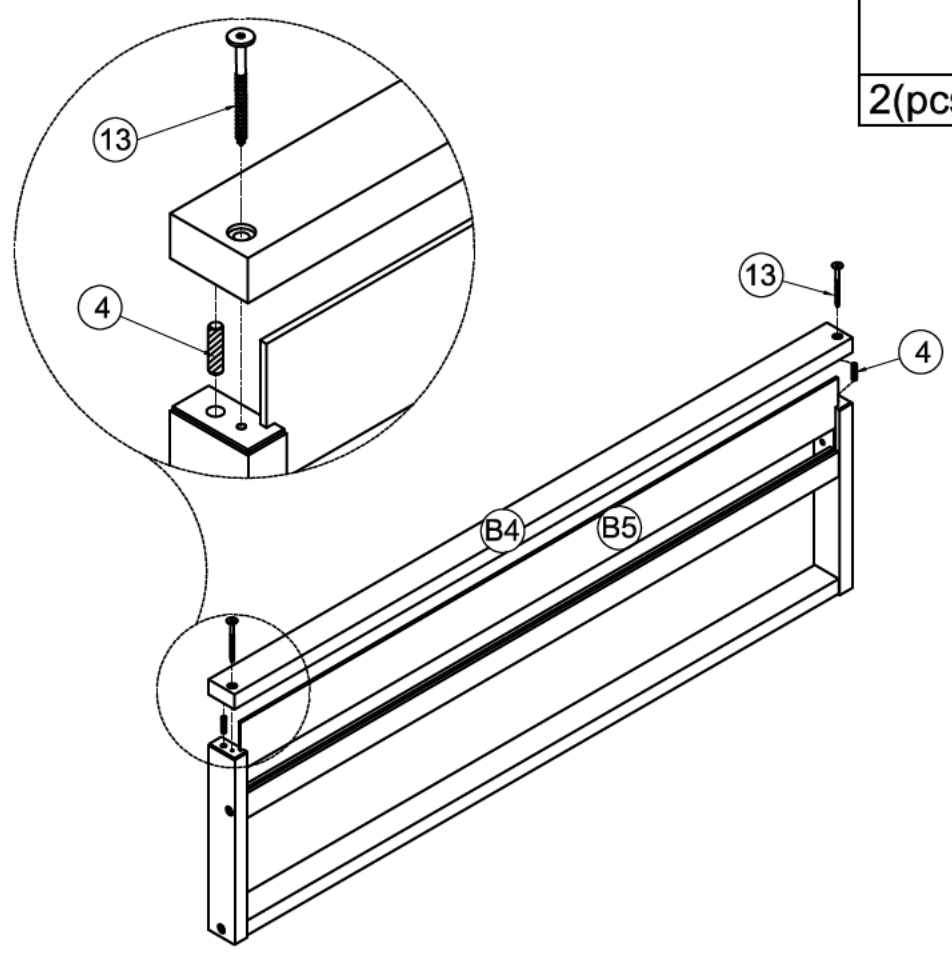

STEP4: Following below illustration.

4		13	
2(pcs)		2(pcs)	



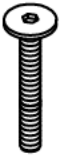

STEP5: Following below illustration.

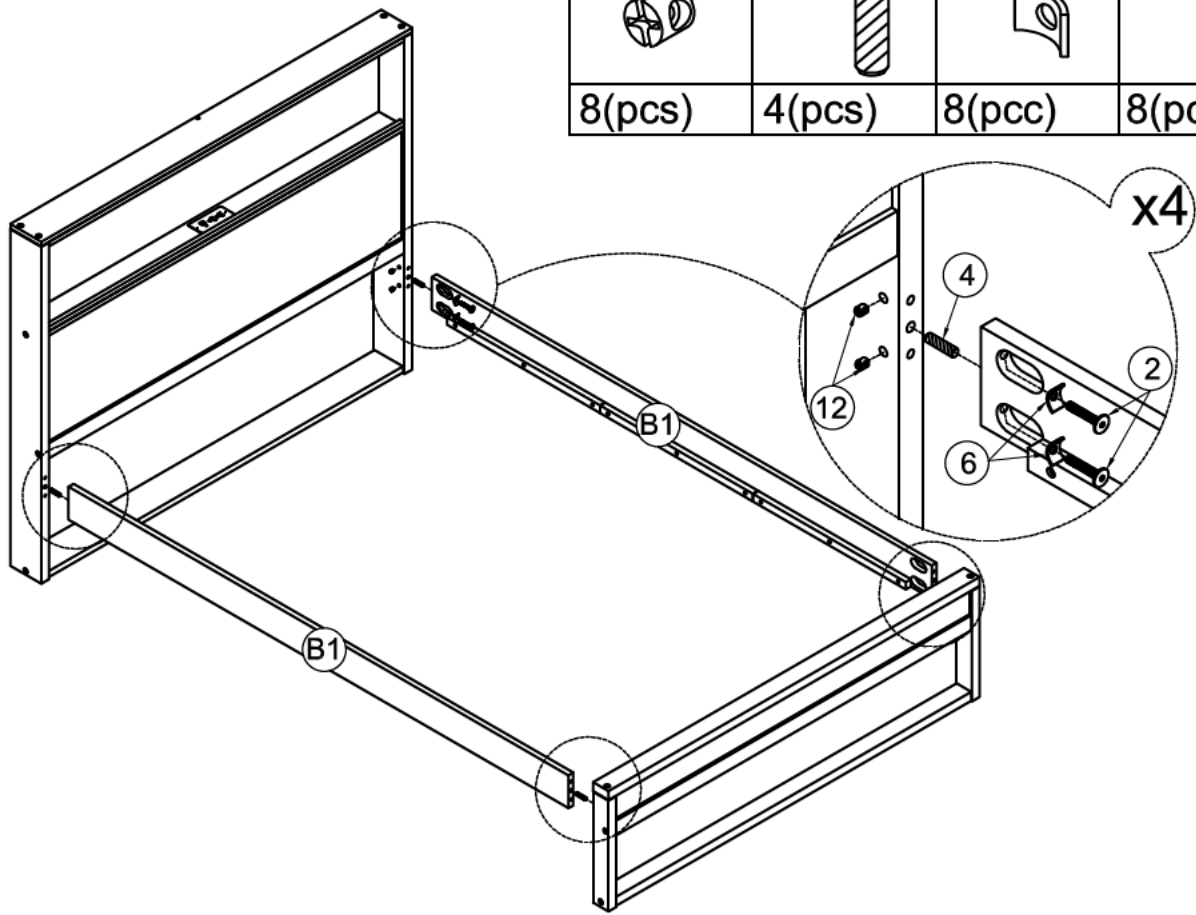
12	4	6	2
			
8(pcs)	4(pcs)	8(pcc)	8(pcs)



STEP6: Following below illustration.

1	5
	
2(pcs)	20(pcs)

