

KAMA

BOKO

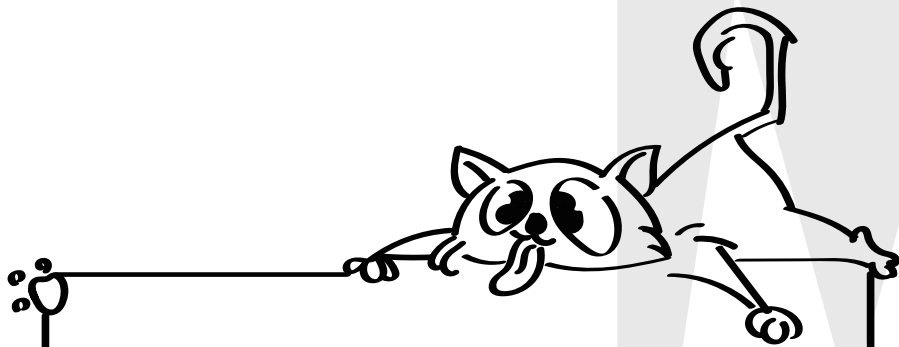

If you're having difficulty, our friendly customer team is always here to help.



WEB:KAMABOKOPETS.com
EMAIL:KMABOKO@163.com

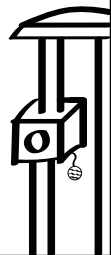

Cat Tree

ITEM-KM061

THIS INSTRUCTION BOOKLET CONTAINS IMPORTANT SAFETY INFORMATION.
PLEASE READ AND KEEP FOR FUTURE REFERENCE.

EN



Before You Start





- ⚠ Please read all instructions carefully.
- ⚠ Retain instructions for future reference.
- ⚠ Separate and count all parts and hardware.
- ⚠ Read through each step carefully and follow the proper order.
- ⚠ We recommend that, where possible, all items are assembled near to the area in which they will be placed in use, to avoid moving the product unnecessarily once assembled.
- ⚠ Always place the product on a flat, steady and stable surface.
- ⚠ Keep all small parts and packaging materials for this product away from babies and children as they potentially pose a serious choking hazard.



EN

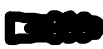





Return / Damage Claim Instructions

- ⚠ **DO NOT discard the box / original packaging.**
In case a return is required, the item must be returned in original box. Without this your return will not be accepted.
- ⚠ **Take a photo of the box markings.**
A photo of the markings (text) on the side of the box is required in case a part is needed for replacement. This helps our staff identify your product number to ensure you receive the correct parts.
- ⚠ **Take a photo of the damaged part (if applicable).**
A photo of the damage is always required to file a claim and get your replacement or refund processed quickly. Please make sure you have the box even if it is damaged.
- ⚠ **Send us an email with the images requested.**
Email us directly from marketplace where your item was purchased with the attached images and a description of your claim.

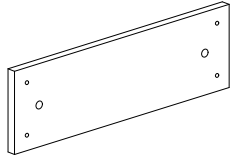
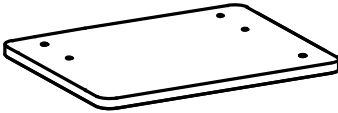
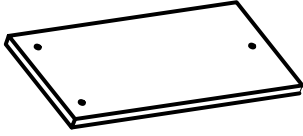
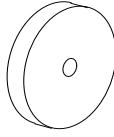
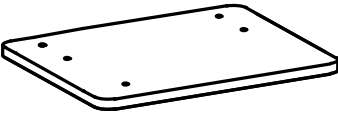
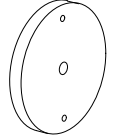
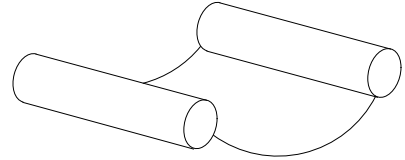
Accessory	Size	Quantity
A 	5mm*60mm	25PCS
B 	8mm*40mm	25PCS
C 	-----	8PCS
D 	6mm*16mm	16PCS
E 	10mm*40mm	2PCS
	5mm	1PC

Plasterboard wall screw installation		
A 	4.5mm*80mm	25pcs
B 	10mm*36mm	25pcs

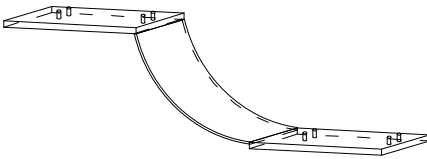
<p>1 440mm*135mm*15mm</p>  <p>1PC</p>	<p>5 440mm*340mm*15mm</p>  <p>1PC</p>	<p>9 390mm*180mm*15mm</p>  <p>1PC</p>
<p>2 90mm*90mm*15mm</p>  <p>2PCS</p>	<p>6 440mm*340mm*15mm</p>  <p>1PC</p>	<p>10 135mm*135mm*15mm</p>  <p>1PC</p>
<p>3</p>  <p>1PC</p>	<p>7 300mm</p>  <p>1PC</p>	<p>11 300mm</p>  <p>1PC</p>
<p>4 300mm</p>  <p>2PCS</p>	<p>8</p>  <p>1PC</p>	

1

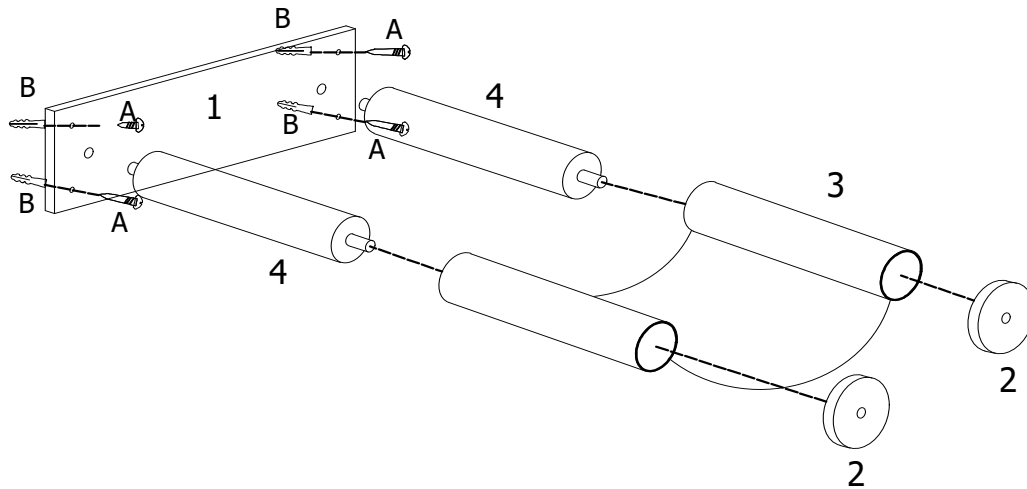

A		x4
B		x4



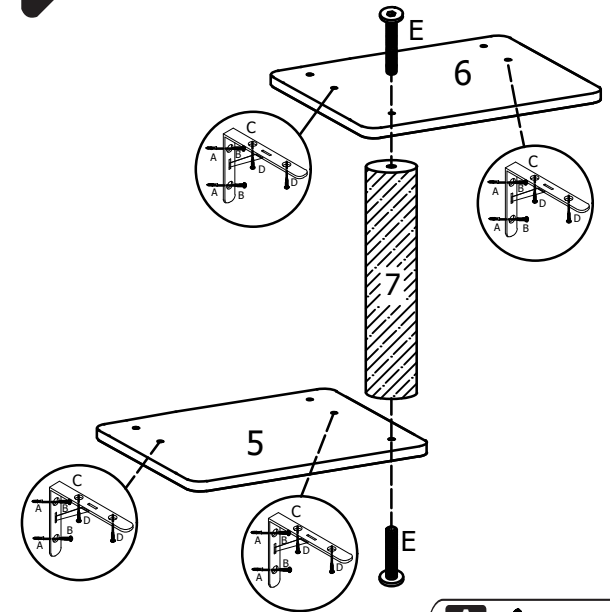

2

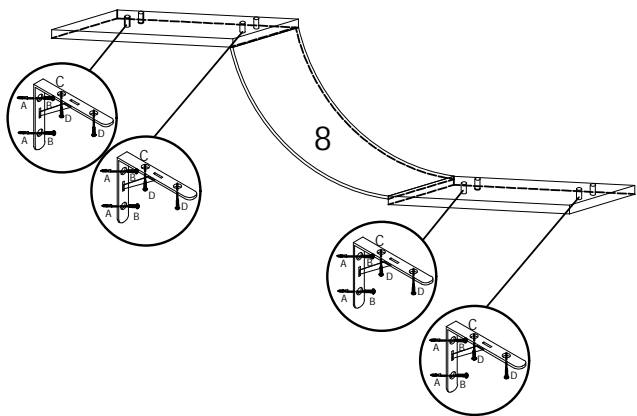

A		x8
B		x8
C		x4
D		x8
E		x2



3



A		x8
B		x8
C		x4
D		x8

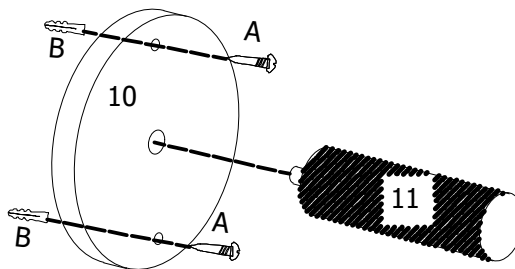

4

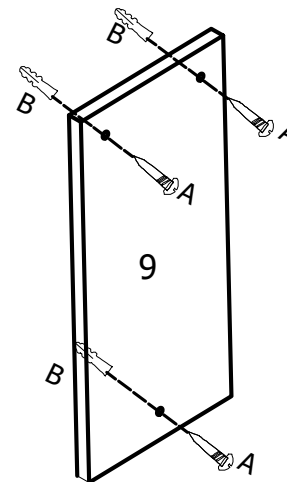

A		x2
B		x2

5



A		x3
B		x3