

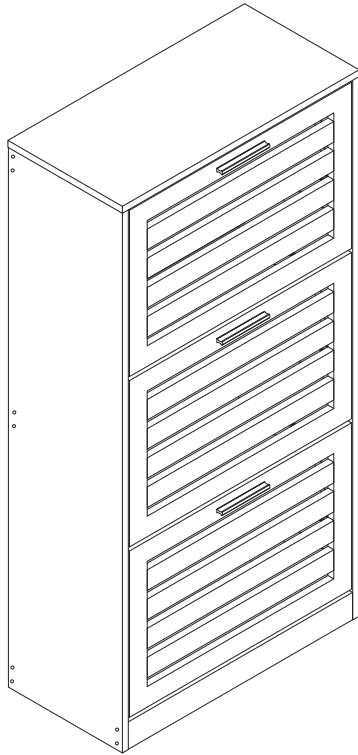

SKU:KHD-EU-BY04-WHE

Lot No.:YFGM-NO.1



Assembly Guide

Tip!

Do check for all the components and screws listed in this guide before putting things together. If any part is missing, contact us at support@vecelo.com (US / CA) or support-euteam@vecelo.com (EU) for the missing part.

Return Policy

Your satisfaction is our top priority. If our product fails to satisfy you, please let us know how we can make things right for you. Our trained customer care team can handle most concerns and assist you with any questions you may have. Simply shoot them a message at support@vecelo.com(US/CA) or support-euteam@vecelo.com(EU) with your orde number and question. To be eligible for a full-refund return, the item must be in pristine condition, in the original packaging, with all of the shipped components intact and not yet assembled, and with the item's unique proof of purchase.

Trouble shooting:

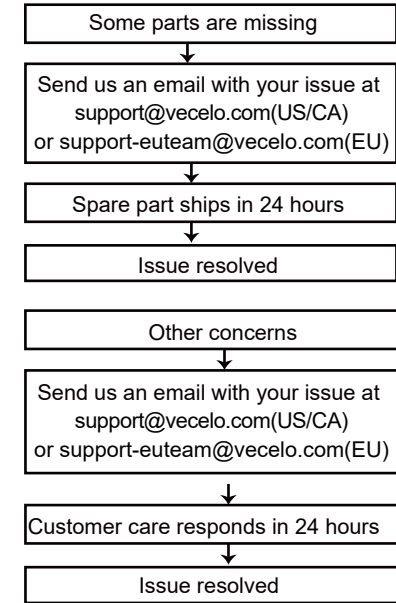

We run our own manufacturer, so rest assured about the quality consistency.

CONTACT US

KONTAKTIEREN SIE UNS

NOUS CONTACTER

CONTATTACI

CONTACTENOS

E-mail: support@vecelo.com (US/CA)

E-mail: support-euteam@vecelo.com (EU/FR/DE/ES/IT)

Website: www.vecelo.com

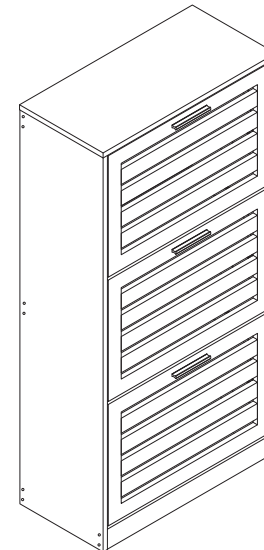

Item Description: Shoe Cabinet

Model NO: YFGM-NO.1

Montageanleitung

Tipp!

ÜBERPRÜFEN Sie alle in dieser Anleitung aufgeführten Komponenten und Schrauben, bevor Sie die Bauteile zusammenbauen. Sollte ein Bauteil fehlen, kontaktieren Sie uns unter support-euteam@vecelo.com, um Ersatz zu erhalten.

Rückgaberichtlinie

Ihre Zufriedenheit ist unsere oberste Priorität. Wenn Sie mit unserem Produkt nicht zufrieden sind, lassen Sie uns bitte wissen, wie wir das Problem für Sie lösen können. Unser geschultes Kundenbetreuungsteam kann die meisten Anliegen klären und Ihnen bei all Ihren Fragen weiterhelfen. Senden Sie uns einfach eine Nachricht an support-euteam@vecelo.com mit Ihrer Bestellnummer und Ihrer Anfrage. Um eine vollständige Rückerstattung zu erhalten, muss der Artikel in einwandfreiem Zustand sein und sich in der Originalverpackung mit allen gelieferten und noch nicht zusammengebauten Komponenten befinden. Zudem ist ein eindeutiger Kaufnachweis erforderlich.

Problemlösung:

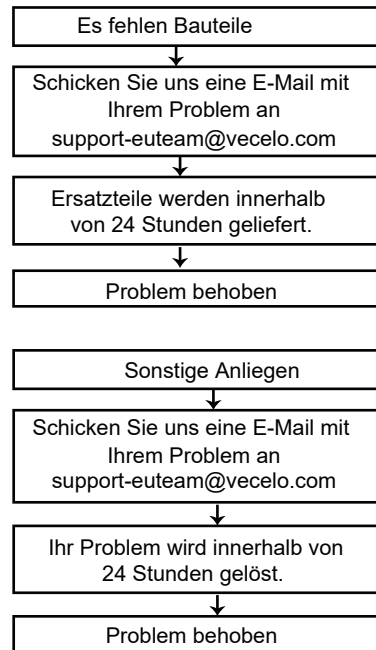

Wir stellen unsere Artikel selbst her, sodass Sie sich auf gleichbleibende Qualität verlassen können.

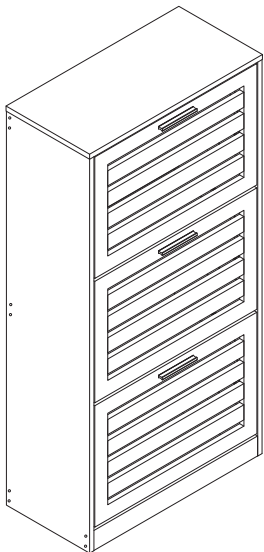
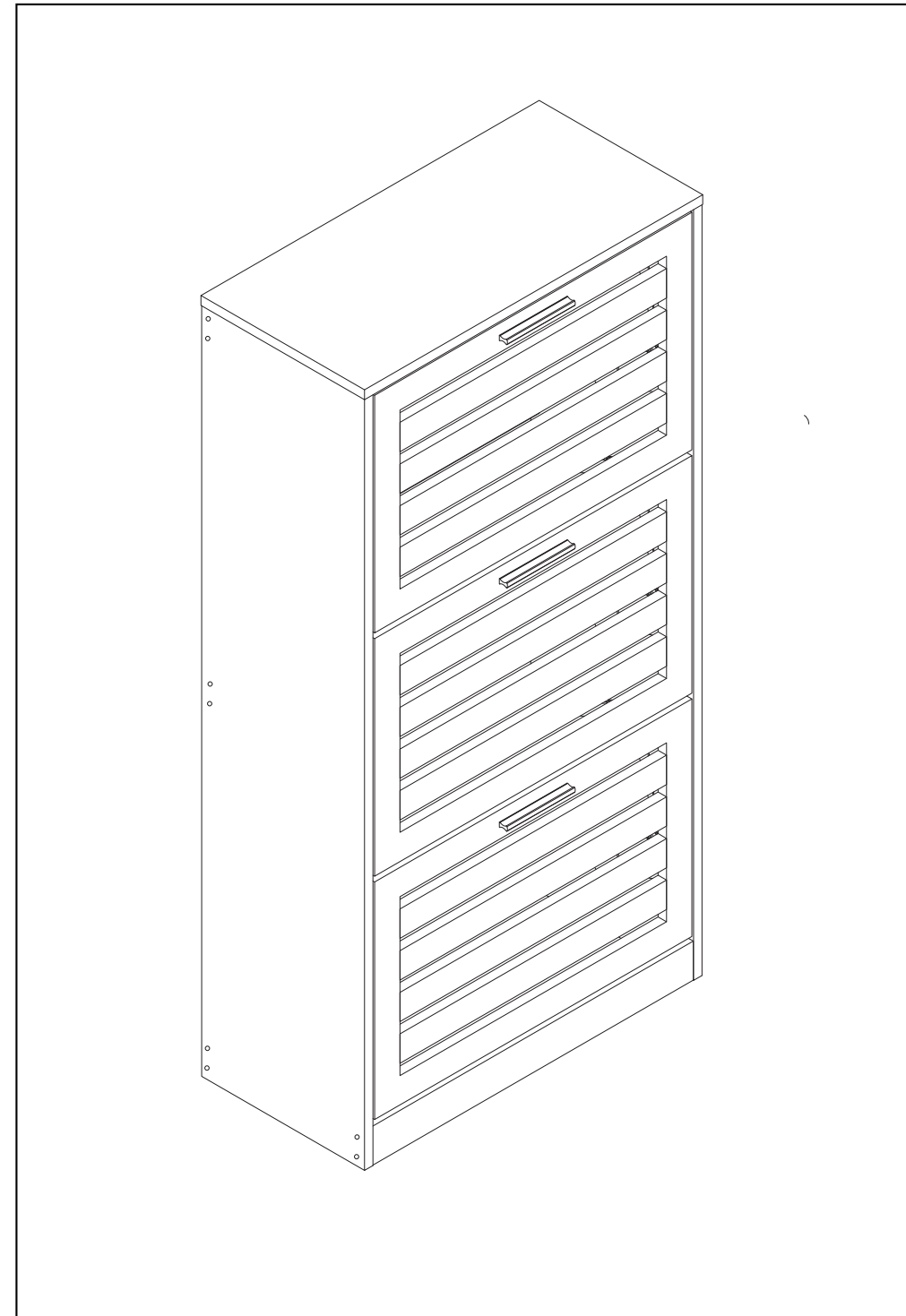

Item Description: Schuhschrank

Model NO: YFGM-NO.1

Step 12

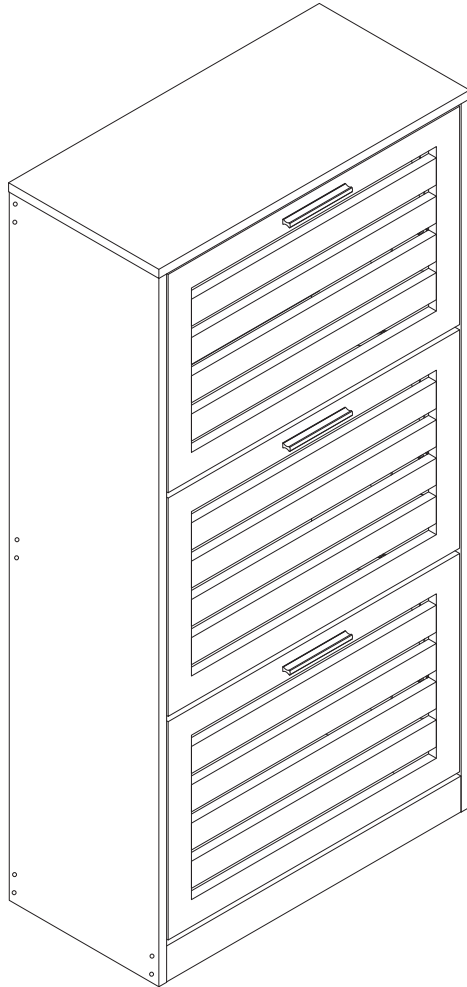

Guide de montage

Attention !

Vérifiez la présence de l'ensemble des éléments et vis énumérés dans ce guide avant de procéder au montage. Si une pièce venait à manquer, envoyez-nous un e-mail à support-euteam@vecelo.com pour nous en informer.

Politique de retour

Votre satisfaction est notre priorité absolue. Si notre produit ne vous donne pas entière satisfaction, n'hésitez pas à nous faire savoir ce que nous pouvons faire pour améliorer la situation. Notre équipe d'assistance à la clientèle qualifiée est en mesure de résoudre la plupart de vos problèmes et de répondre à toutes vos questions. Il vous suffit de leur envoyer un message à l'adresse support-euteam@vecelo.com en indiquant votre numéro de commande et votre question. Pour pouvoir bénéficier d'un remboursement intégral, l'article doit être en parfait état, dans son emballage d'origine, avec tous les composants expédiés intacts et non encore assemblés, et avec la preuve d'achat de l'article"

Dépannage :

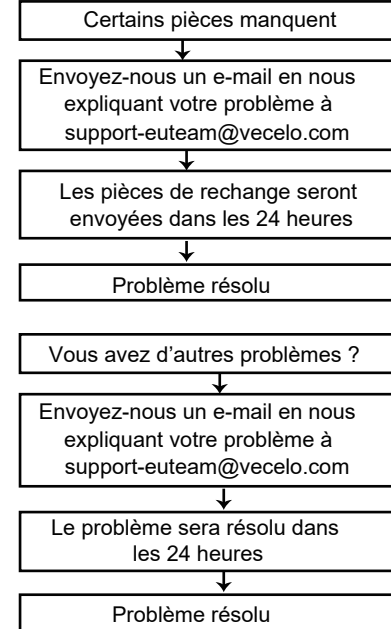

Nous assurons notre propre fabrication donc soyez assuré de bénéficier d'une qualité constante.

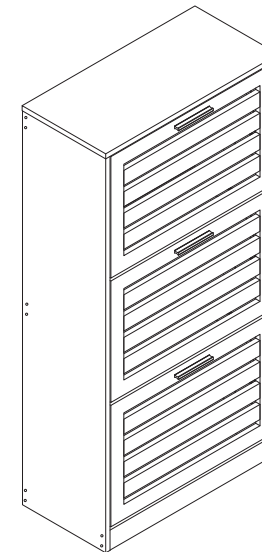

Item Description: Armoire à chaussures

Model NO: YFGM-NO.1

Guida all'assemblaggio

Suggerimento!

Controllare tutti i componenti e le viti elencati in questa guida prima di assemblare il tutto. Se manca qualche parte, contattaci a support-euteam@vecelo.com per le parti mancanti.

Politica di reso

La vostra soddisfazione è la nostra massima priorità. Se il nostro prodotto non ti soddisfa, faccelo sapere e ti aiuteremo a risolvere il problema. Il nostro team di assistenza clienti qualificato può gestire la maggior parte delle preoccupazioni e assisterti per qualsiasi domanda tu possa avere. Inviaci semplicemente un messaggio a support-euteam@vecelo.com con il tuo numero d'ordine e la tua richiesta. Per essere idoneo a un reso con rimborso completo, l'articolo deve essere in ottime condizioni, nella confezione originale, con tutti i componenti intatti e non ancora assemblati, e con una prova d'acquisto valida.

Risoluzione dei problemi:

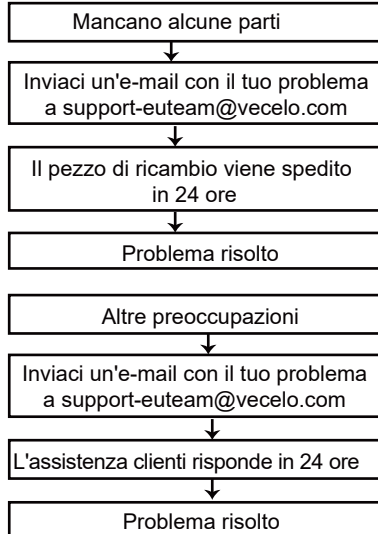

Gestiamo direttamente il nostro produttore, quindi puoi essere sicuro della qualità costante.

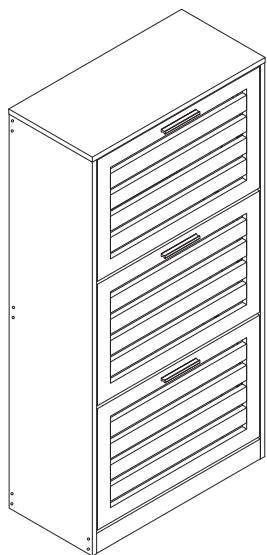

Descrizione dell'articolo: Armadio per scarpe

Modello NO: YFGM-NO.1



Step 11

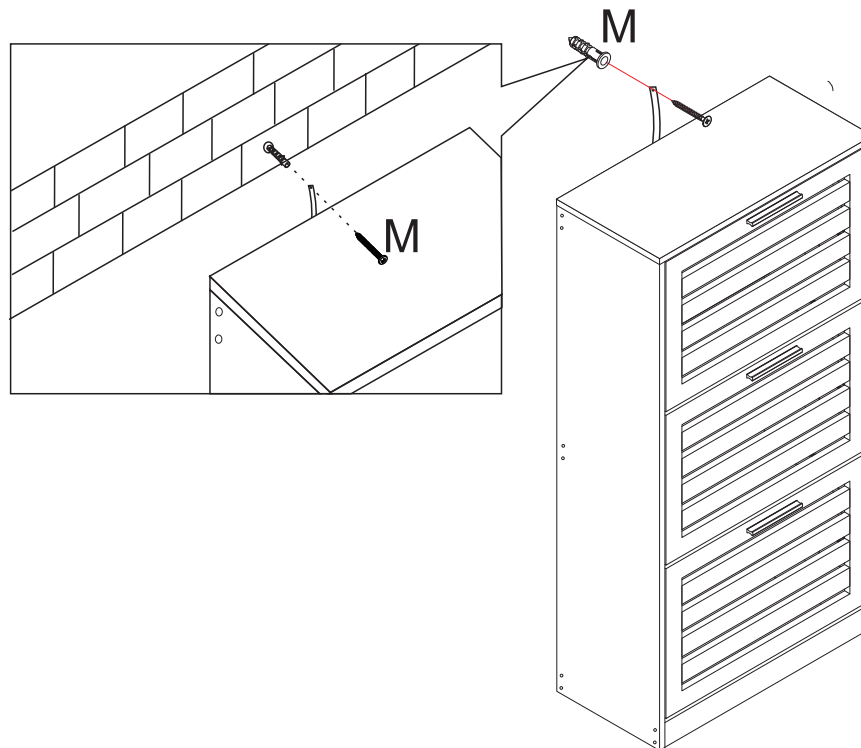

Mx1



Step 10

	Ex1
	Px1

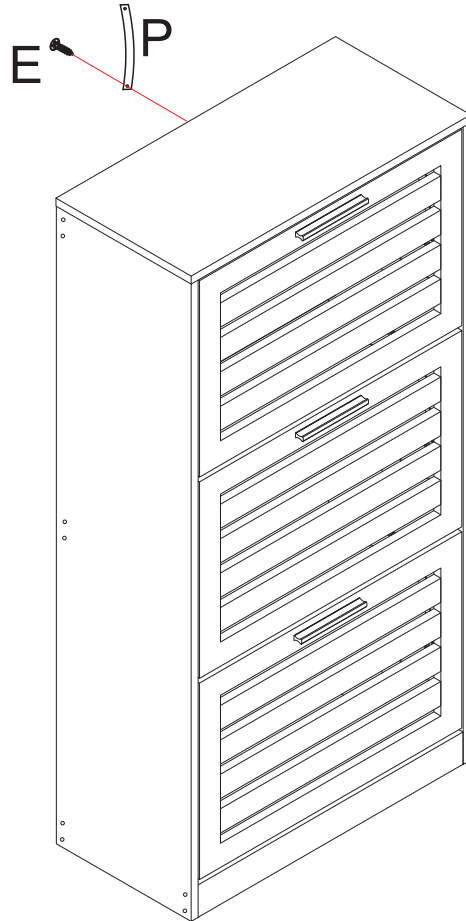

SKU:KHD-EU-BY04-WHE

Lot No.:YFGM-NO.1

Guía de montaje

Consejo!

Verifique todos los componentes y tornillos enumerados en esta guía antes de ensamblar todo. Si falta alguna pieza, contáctanos a support-euteam@vecelo.com para las piezas faltantes.

Política de devoluciones

Su satisfacción es nuestra máxima prioridad. Si nuestro producto no le satisface, háganoslo saber y le ayudaremos a resolver el problema. Nuestro equipo de atención al cliente capacitado puede manejar la mayoría de las inquietudes y ayudarlo con cualquier pregunta que pueda tener. Simplemente envíenos un mensaje a support-euteam@vecelo.com con su número de pedido y su consulta. Para ser elegible para una devolución con reembolso completo, el artículo debe estar en impecable estado, en su embalaje original, con todos los componentes intactos, no ensamblado y con un comprobante de compra válido.

Solución de problemas:

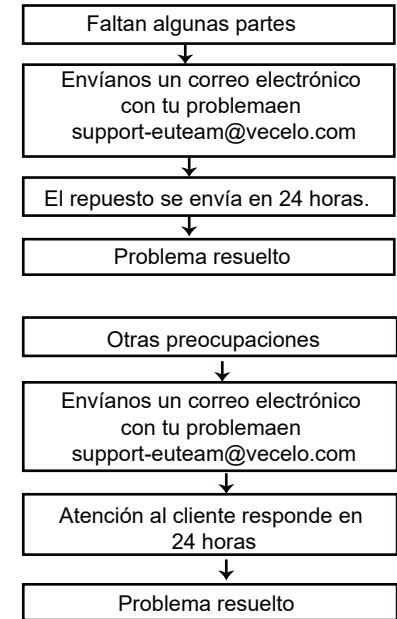

Gestionamos directamente con nuestro fabricante, así que puede estar seguro de la consistencia de la calidad.

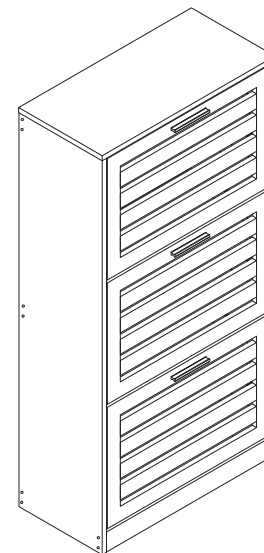



Descripción del artículo: Gabinete para zapatos

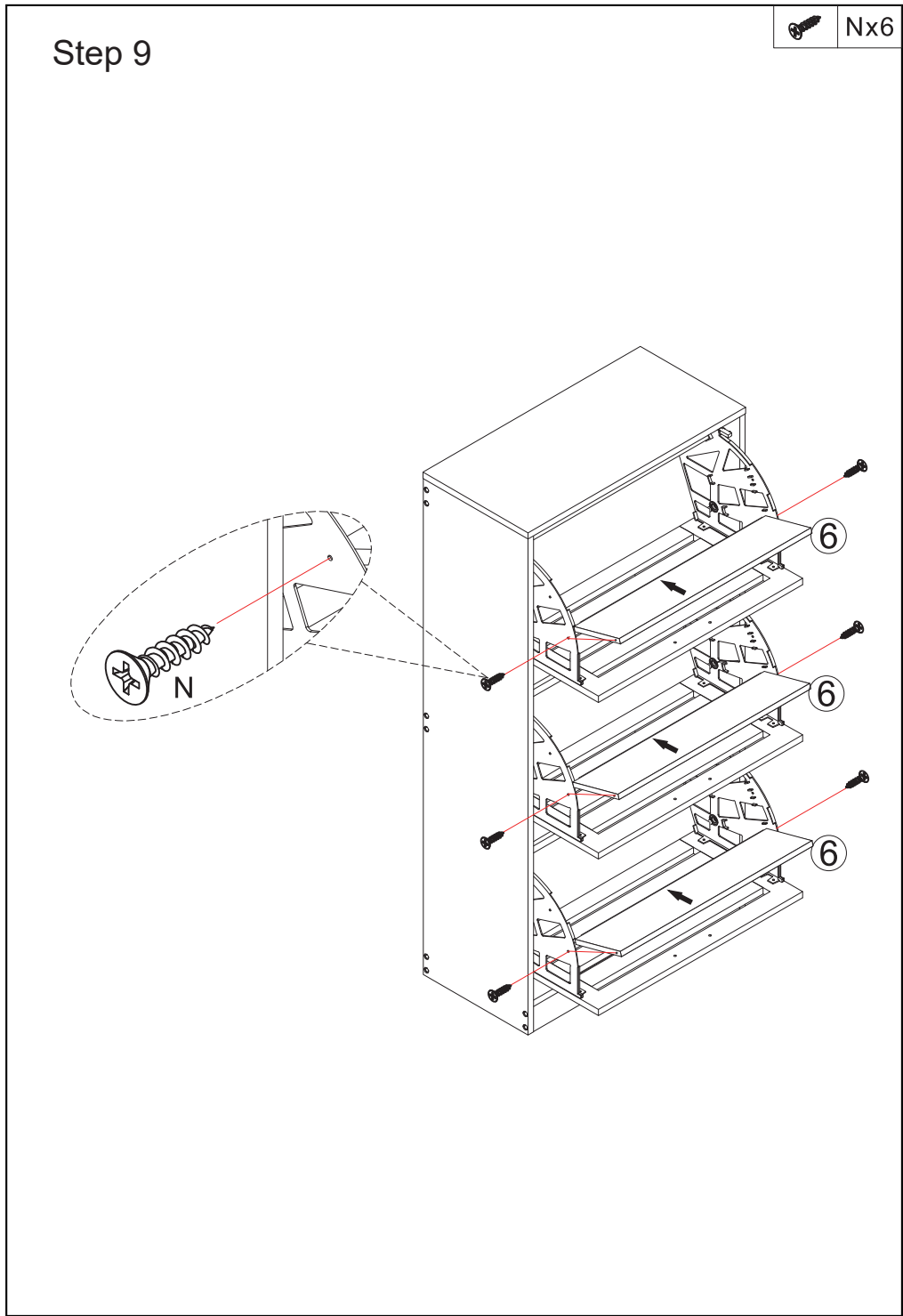
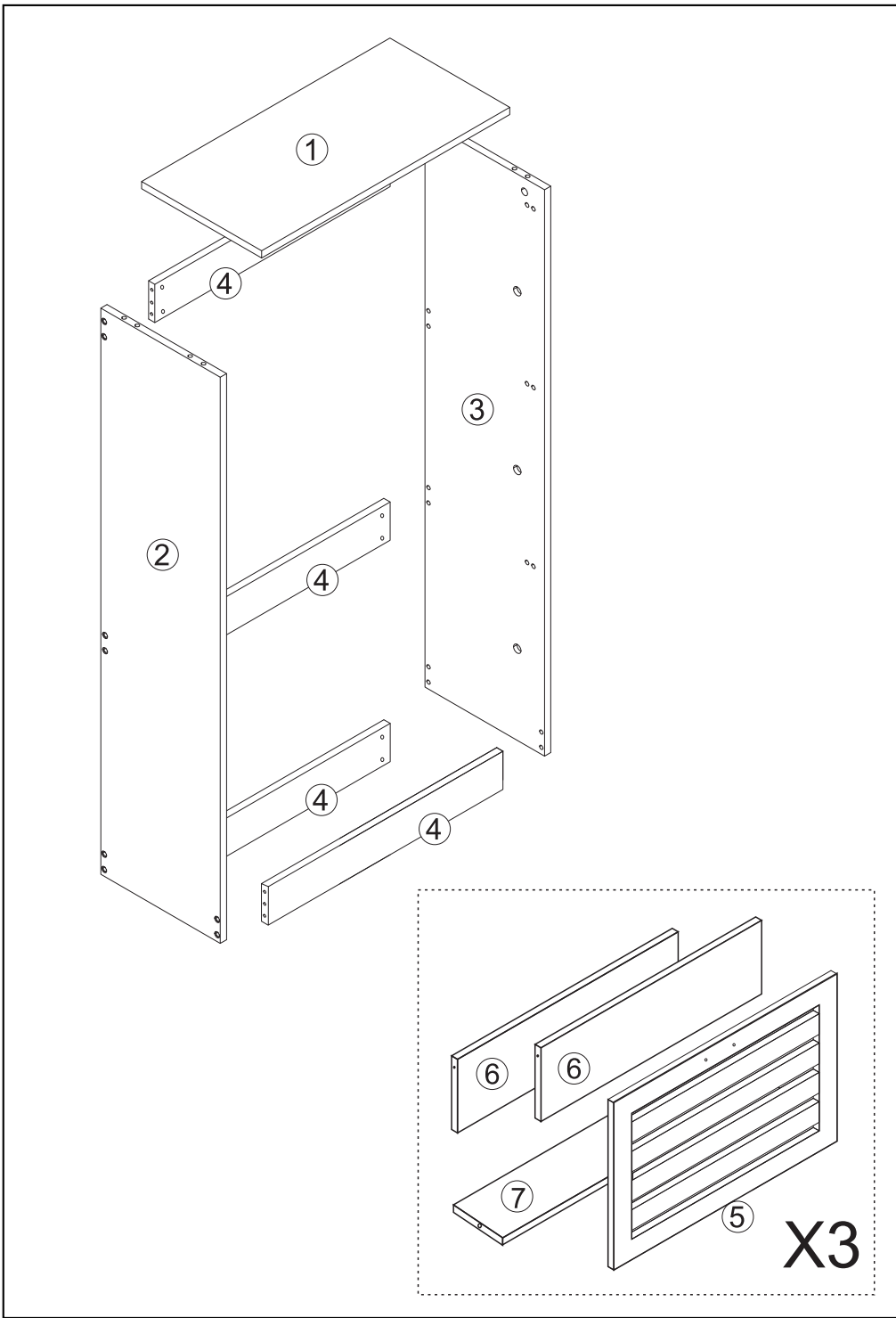

Modelo NO: YFGM-NO.1





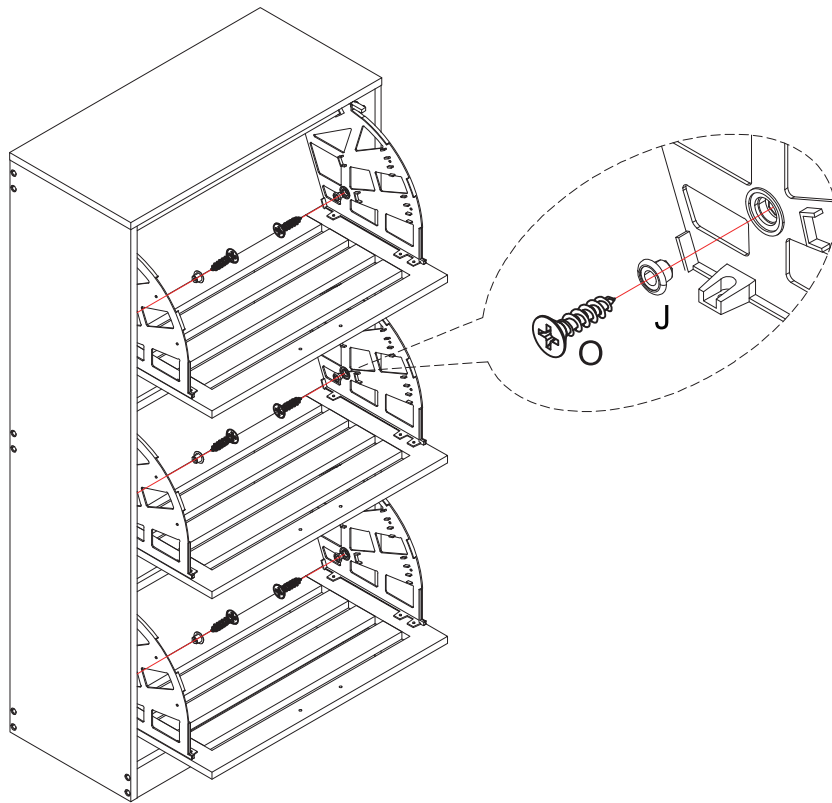

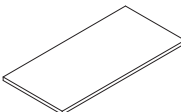

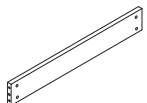
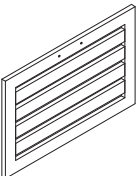
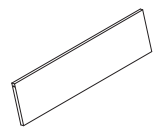
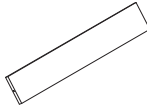







Step 8



-  Jx6
-  Ox6

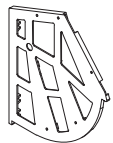
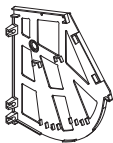

Components / Bauteile / Composants / Componenti / Componentes /					
1	 600x290x15mm	1pc	2	 1185x289x15mm	1pc
3	 1185x289x15mm	1pc	4	 569x80x15mm	4pcs
5	 563x365x15mm	3pcs	6	 557x143x12mm	6pcs
7	 557x93x12mm	3pcs			

A	 Ø6x35mm	4pcs	B	 Ø15x12mm	4pcs
C	 Ø8x30mm	12pcs	D	 Ø5x40mm	16pcs
E	 Ø4x12mm	19pcs	F		3pcs
G	 Ø4x16mm	6pcs	H		6pcs
I		6pcs	J		6pcs
M		1pc	N	 Ø4x25mm	18pcs
O	 Ø3x16mm	6pcs	P		1pc
Q		16pcs			
Put on the other side					
K		3pcs	L		3pcs

Step 7

	Ex18
	Gx6
	Fx3

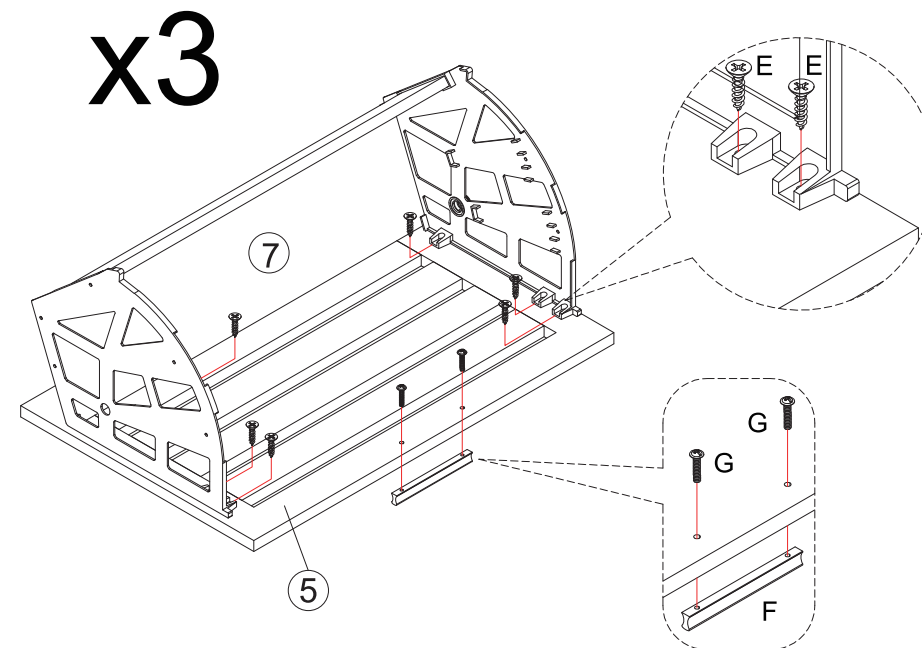

Step 6

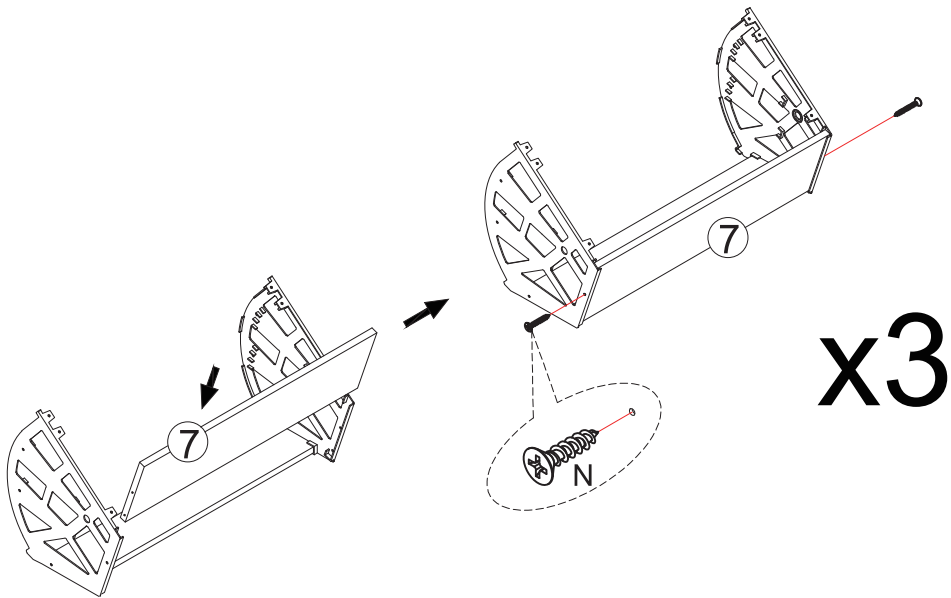

 Nx6

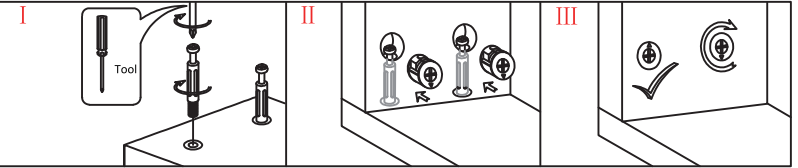

"A&B" Hardware
Assembly example



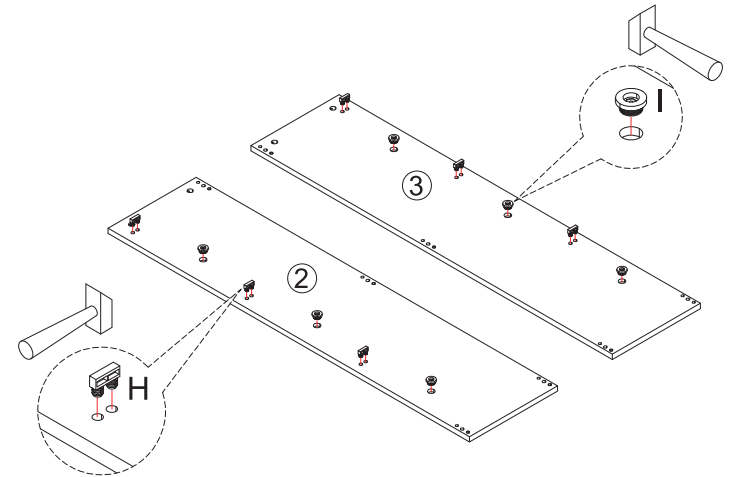

Step 1

 Hx6
 lx6



Step 2

 Cx8
 Dx16
 Qx16

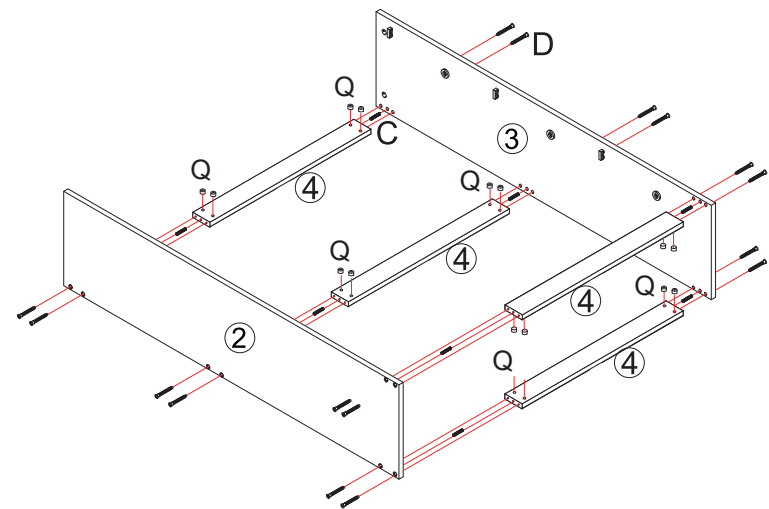

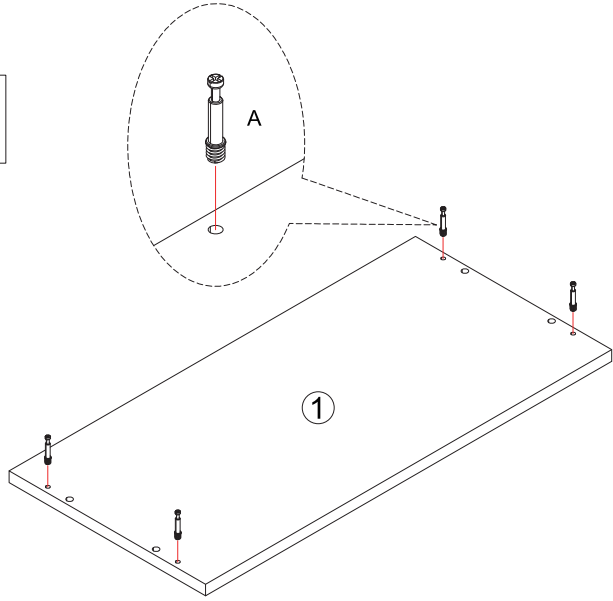

Step 3

 Ax4



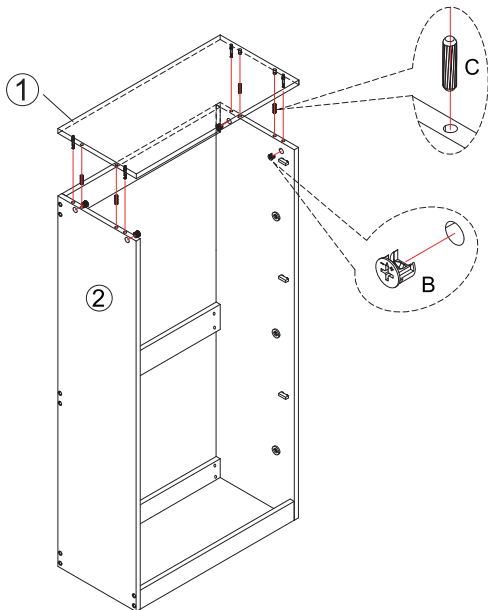
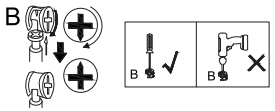

Step 4

 Bx4
 Cx4



Step 5

 Nx6
 Kx3
 Lx3

