

Following these mounting instructions with the hardware included will be more than sufficient to support wall mounted installation.

### Included Installation Hardware

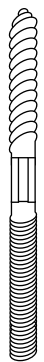

x2 Hanger Bolts (8mm)



x2 Washer



x2 Wall Anchor



x2 Nuts



x2 Insulation Sleeve

### Tools You May Need

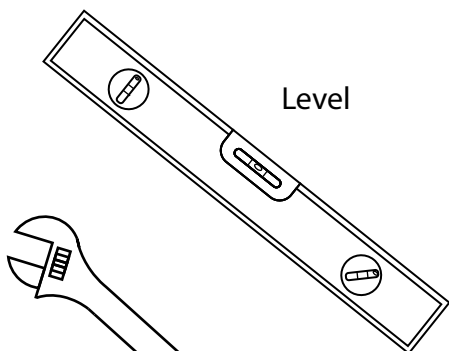

Level

Wrench

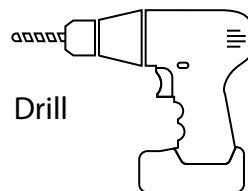

Drill

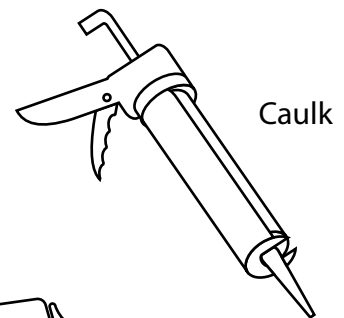

Caulk



Tape Measure

## 1. Prepare Location

---

Locate studs in the wall. If the studs do not line up with the holes in the back of the sink, be sure to add sufficient wall supports behind the finished wall.

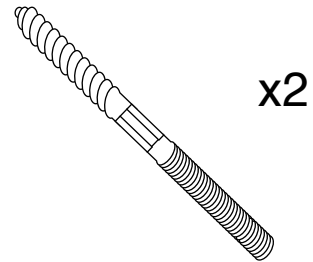
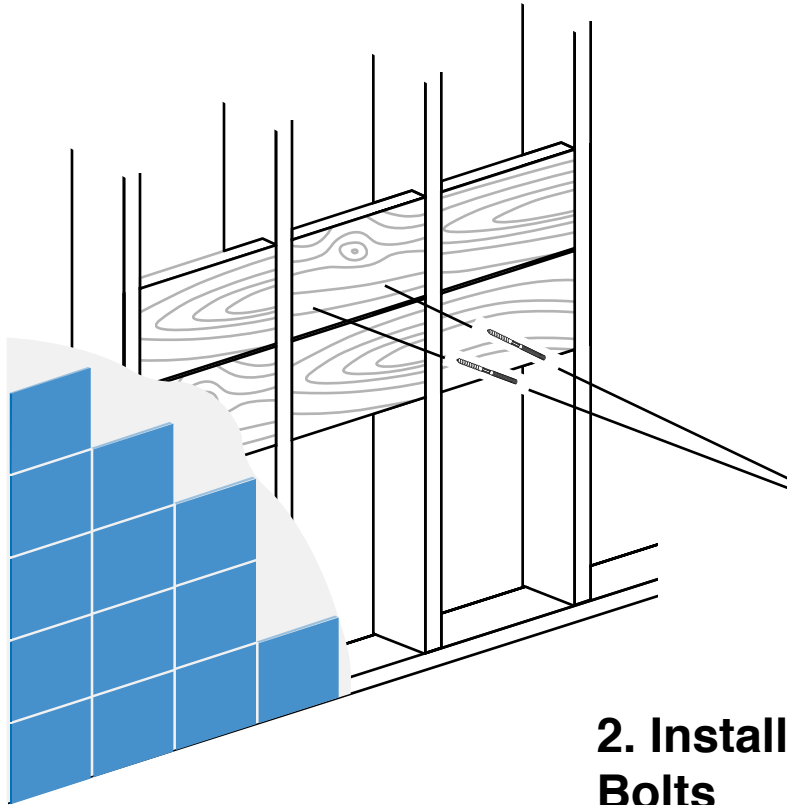

## 2. Install Hanger Bolts

---

Measure the distance between mounting holes in the back of the sink. Drill pilot holes in wood and screw in hanger bolts. Check position with a level.

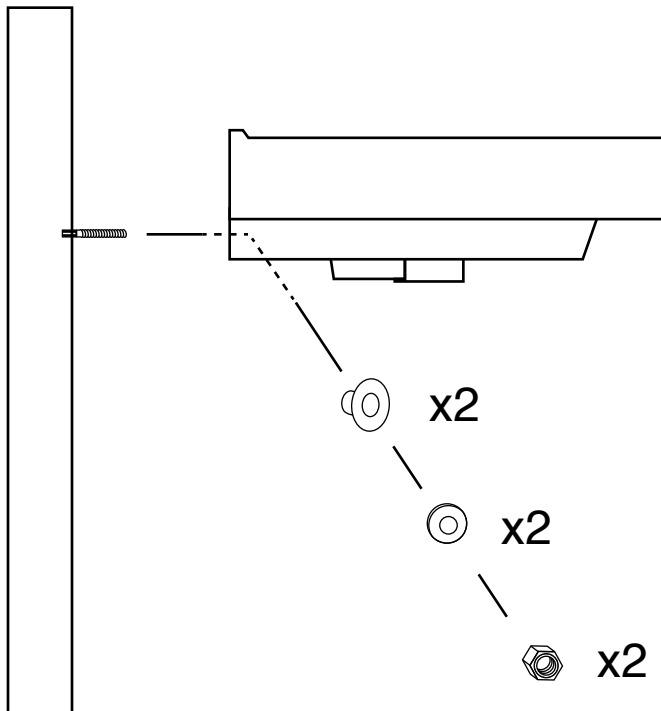

## 3. Secure Sink With Washers and Nuts

---

Thread the sink on to the two hanger bolts. Secure the sink with insulation sleeves, washers and nuts. Be careful not to over tighten the bolts. Over tightening can cause the sink to chip and crack.

## 4. Install Caulk

---

Finish the sink installation with a bead of caulk between the sink and wall.

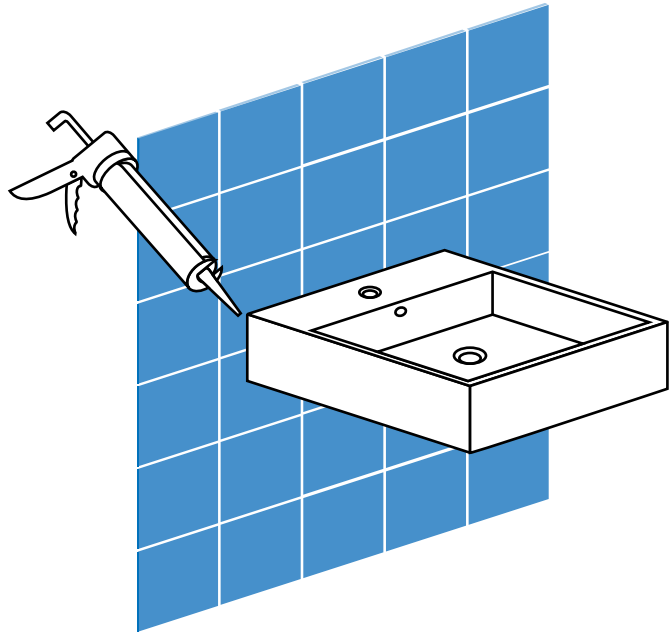

## 5. Sink Accessories

---

Complete your installation by adding the preferred plumbing accessories, such as the faucet, click clack drain, p-trap and angle valves to your sink.

