

ASSEMBLY INSTRUCTIONS

VANITY TABLE AND MIRROR

Caution: Please read instructions thoroughly before unpacking assembly parts. Sharp, exposed staple tips can cause injury, therefore, for your protection, please remove any exposed staple used in packing.

1. We recommend that you should assemble this product with the assistance of another person; this will make assembly easier, and will help to eliminate damage to the product or injury to persons during assembly.
2. Be sure to check all packing materials carefully for small parts that may have come loose inside the carton during shipment.
3. please do not over tighten screws or bolts.
4. Please put all parts on a non-abrasive floor before assembly, and follow the assembly steps to assemble your newly purchased product correctly and efficiently.



HARDWARE LISTS				PARTS LIST			
NO:	COMPONENT		Q'TY	NO.	DESCRIPTION	SKETCH	Q'TY
A	JCBC Bolt 1/4" *20*35mm		12	(1)	BASE (Left & right)		2PCS
B	Spring Washer 1/4" Dia		12	(2)	LEG		8PCS
C	Flat Washer 1/4" Dia		12	(3)	BOX		1PC
D	Allen Key		1	(4)	TIPPING RESTRAINT		1PC
E	GLASS		1	(5)	MIRROR		1PC
F	GLASS CLAMP		4	(6)	MIRROR SUPPORT		2PCS

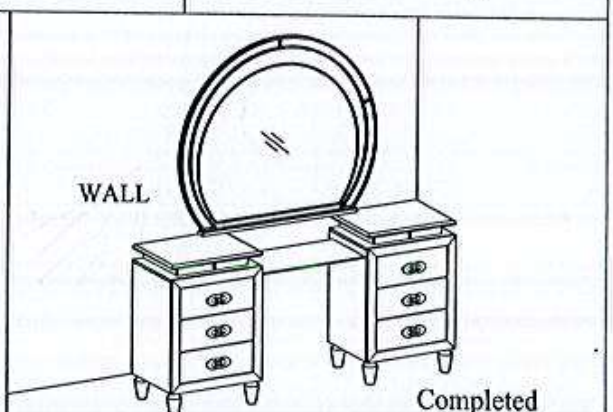
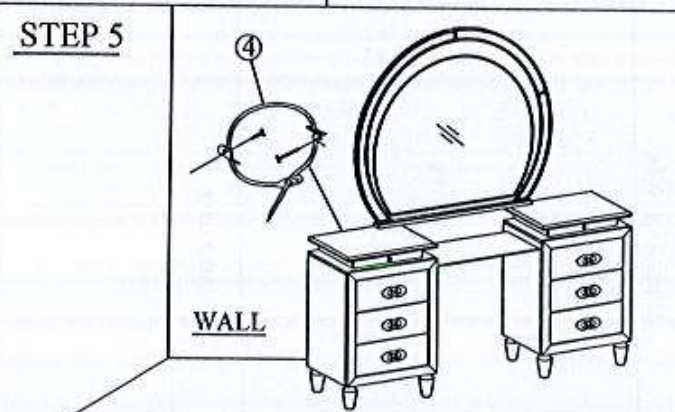
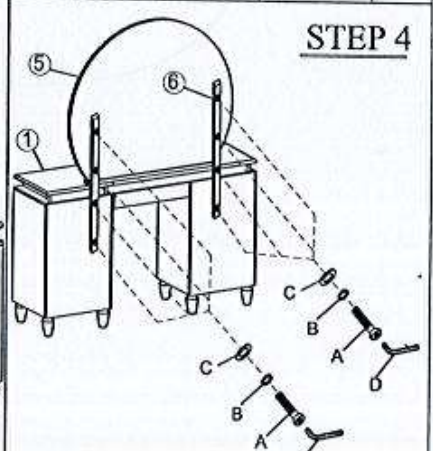
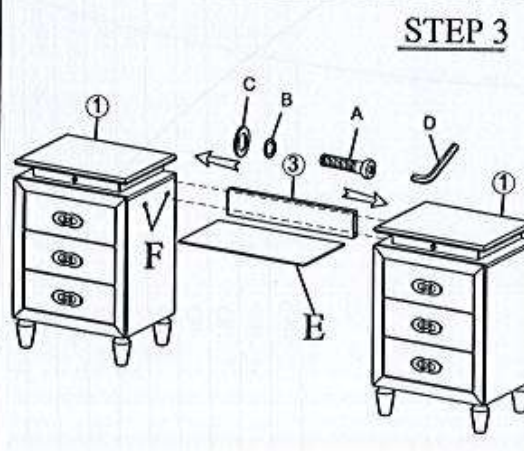





ASSEMBLY INSTRUCTIONS

STOOL

Caution: Please read instructions thoroughly before unpacking assembly parts. Sharp, exposed staple tips can cause injury, therefore, for your protection, please remove any exposed staple used in packing.

1. We recommend that you should assemble this product with the assistance of another person; this will make assembly easier, and will help to eliminate damage to the product or injury to persons during assembly.
2. Be sure to check all packing materials carefully for small parts that may have come loose inside the carton during shipment.
3. please do not over tighten screws or bolts.
4. Please put all parts on a non-abrasive floor before assembly, and follow the assembly steps to assemble your newly purchased product correctly and efficiently.

HARDWARE LISTS			
NO:	COMPONENT	Size	Q'TY
a	JCBC Bolt 5/16" *2"L		8pcs
b	Spring Washer 5/16" Dia		8pcs
c	Flat Washer 5/16" Dia		8pcs
d	Allen Key		1pc

PART LISTS			
NO.	DESCRIPTION	SKETCH	Q'TY
(1)	STOLL CUSHION SEAT FRAME		1PC
(2)	STOOL LEG		4PCS

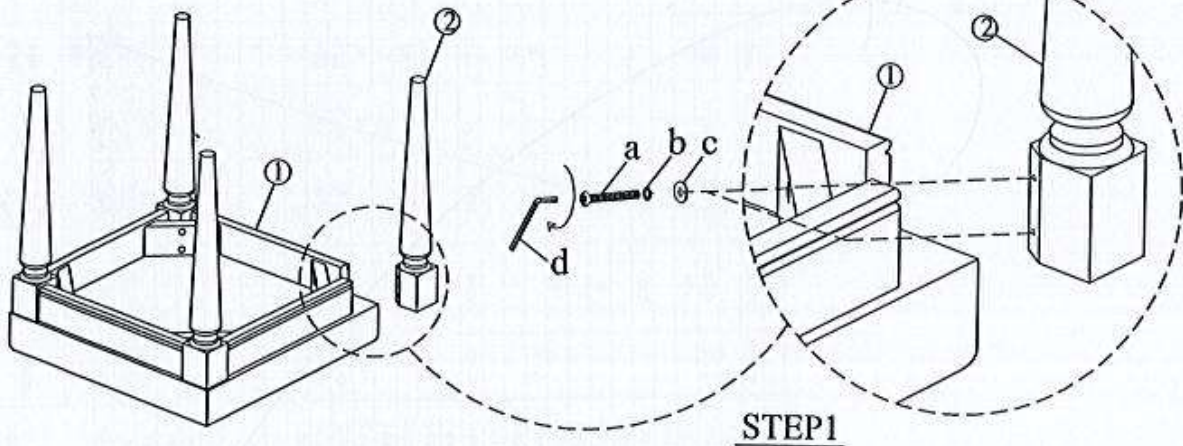

FINAL

