

WARNING

- * Switch off the main electrical supply from the main fuse box / circuit breaker before installation.
- * Inspect item carefully before attempting to install.
- * If there is any damages or obvious defects, do not install.
- * Item may not be returned once it has been installed.

CARE AND MAINTENANCE

- * To clean the outside of the fixture, use a dry or slightly dampened clean cloth (use clean water, never a solvent) to wipe the surface of the fixture.
- * To clean the inside of the fixture, first disconnect power to the fixture by turning off the circuit breaker or by removing the fuse at the fuse box. Next, use a dry or slightly dampened clean cloth (use clean water, never a solvent) to wipe the interior surface of the fixture.
- * Do not use any cleaners with chemical, solvents or harsh abrasives. Use only a dry soft cloth to dust or wipe carefully.





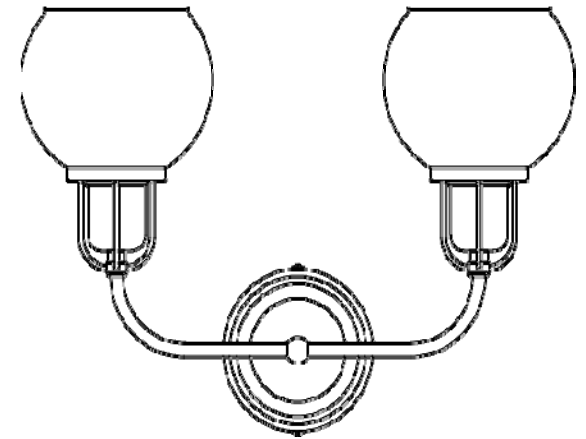

NOTICE & IMPORTANT SAFETY INSTRUCTIONS

- ** WE RECOMMEND INSTALLATION OF THIS LIGHTING FIXTURE BE DONE BY A LICENSED ELECTRICIAN **
- * Please make sure that you have all parts indicated before you begin assembly of this item
- * This item should be assembled on a soft surface to prevent scratching the finish during assembly
- * To reduce the risk of fire, electrical shock or injury to persons or property, please follow the guideline below for safe use and installation
- *The external flexible cable or cord of this lamp cannot be replaced
If the cord is damaged, the lamp shall be destroyed

Product Dimensions: 15.75" L x 6.75" W x 12" H

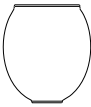
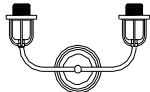

Part List and Hardware List

| PIECE | DESCRIPTION | PICTURE | QUANTITY | PIECE | DESCRIPTION | PICTURE | QUANTITY |
|-------|------------------|---|----------|-------|-------------|---|----------|
| A | Mounting bracket |  | 1X | B1 | Wire nut |  | 3X |
| A1 | Outlet box screw |  | 2X | C | Light bulb |  | 2X |
| A2 | Canopy screw |  | 2X | D | Glass shade |  | 2X |
| B | Fixture body |  | 1X | E | Socket ring |  | 2X |

PREPARATION

- * Before beginning assembly of product, make sure all parts are present. Compare parts with package contents list and hardware contents list.
- * If any part is missing or damaged, do not attempt to assemble the product.
- * Estimated Assembly Time: 20 minutes.
- * Tools Required for Assembly (not included): Screwdriver, Junction box
- * If you are having difficulty, our friendly Customer Care team is always here to help.

NOTE: PLEASE USE TYPE "G" BULB MAX 40-WATT OR LED BULB MAX 9-WATT, THERE IS LED 4-WATT BULB IN THE BOX

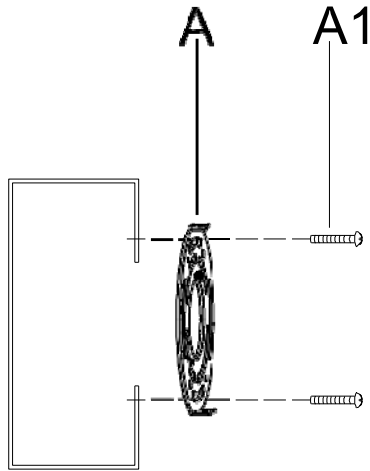

Step 1: Secure mounting plate (A) to outlet box with mounting screws (A1) .

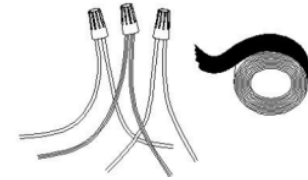
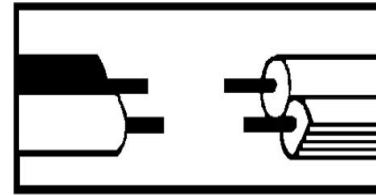

Step 2: Wire connection

Connect fixture neutral wire (ribbed) to the outlet box neutral wire (usually white) using a wire nut. Connect fixture hot wire (smooth with markings) to the outlet box hot wire (usually black) using a wire nut. CAUTION: Do not reverse the hot and neutral connections.

Grounding Instructions:

Wrap ground wire from outlet box around green ground screw on mounting bracket, no less than 2" from wire end. Tighten ground screw. If fixture is supplied with a ground wire, connect to outlet ground wire with a wire connector.

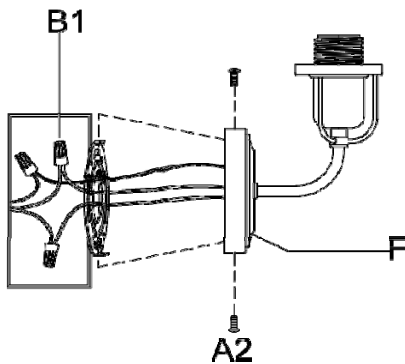

Step 3: Attach the backplate (F) to the mounting bracket (A), secure with canopy screw (A2).

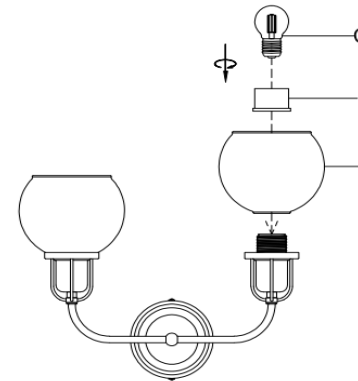

Step 4: Separate the Socket Ring (E) from the Socket (F) anti-clockwise, then Put the shade (H) onto the Socket (F) by turning the Socket Ring (E) clockwise. Insert the bulb (D) into the Socket (F)