

Installation Manual

- Thank you for choosing our products. Please read the instructions carefully before installation and keep it available for future maintenance or reference.

Get free technical support for the lifetime of your product.

Email: service@ihatit.com

Phone: (+1) 702 610 2950

Thank you for purchasing this smart toilet.

Before installation and use, please carefully read the instructions and related illustrations.

Please note that there may be slight differences between the actual product and the illustrations.

If you encounter any issues during installation or operation, please feel free to contact us.

CONTENTS

Chapter 1 Safety Precautions	02
1.1 Normal use	02
1.2 User requirements.....	03
1.3 Use the product only if it is fully functional.....	03
1.4 Toilet seat use	03
1.5 Battery use	03
1.6 Other safety precautions	04
Chapter 2 Installation Instructions	08
2.1 Toilet main body.....	08
2.2 Remote control key diagram	09
2.3 List of materials	11
2.4 Important notes for installation.....	12
2.5 Product installation	13
Chapter 3 Operating Instructions	18
3.1 Initialization operation.....	19
3.2 Operation instructions of toilet side buttons	20
3.3 Operation instructions of remote control.....	21
Chapter 4 Cleaning and Maintenance	30
4.1 Toilet seat cleaning	30
4.2 Sprayer and nozzle cleaning	31
4.3 Remote control cleaning	31
4.4 Waste disposal	32
4.5 Product maintenance	32
4.6 Product maintenance in winter	33
Chapter 5 Troubleshooting	34
Chapter 6 Technical Data	38

Chapter 1 Safety Precautions

In order to prevent harm to the user or others and property damage, please read the [Safety Precautions] carefully.



Serious injury or death may result if this sign is disregarded.



Personal injury or property damage may result if this sign is disregarded.

The sign and its meaning are described as follows:



This sign indicates 'Mandatory' content that must be implemented.



This sign indicates that 'Prohibited' contents are not allowed.



This sign indicates that disassembly or unauthorized modification of the product is prohibited.



This sign indicates that the product is connected to a grounding wire.



This sign indicates that immersion in water is prohibited.



This sign indicates that wet hands are prohibited.



This sign indicates that high temperature and flammable objects are prohibited.

To ensure that you enjoy the functions of this product, please read these instructions carefully, especially the safety precautions. Please keep this manual properly and be sure to bring it with you when you pass it on to someone else for use. All instructions have been confirmed at the time of printing and delivery in accordance with the latest technical conditions of the equipment. We reserve the right to make changes due to further developments.

1.1 Normal use

This product is a smart toilet with rear & lady wash and other comfortable functions, which also can be used as an ordinary toilet. It can only be used for enclosed spaces, any other use will be deemed to be inconsistent with normal use.

The company shall not be liable for abnormal use.

1.2 User requirement

Persons (including children) with physical, sensory, or mental impairments or lack of experience and common sense must be supervised in the use of the product and children should not play with the product.

1.3 Use the product only if it is fully functional



Make sure the power cord is not damaged. If the power cord is damaged, it must be replaced by the manufacturer, after service department, or an expert for replacement.

The power cord must not be snagged or pinched.

Keep the cord away from hot surfaces and sharp edges.

Do not use the unit if it is not working properly. Immediately disconnect the power supply, close the shut-off valve, stop the water supply and contact the customer service.

Stop the water supply and contact the customer service to avoid product malfunction and damage caused by improper use.

1.4 Toilet seat use

Cold water for this appliance should be connected from the main water supply. Use the new hose assembly supplied with the appliance. The old hose assembly cannot be reused.

The water inlet pressure of this product is: 11psi-108psi.

Fixed wiring must be equipped with a tactile switch in accordance with the wiring rules, providing a full-stage disconnection under over voltage class III conditions.

The specification of the power supply cord for fixed wiring is 1-2mm² (17-14AWG) nominal cross-sectional area of the conductor.

Make sure that the ground terminal of the power supply wire is 10mm (3/8") longer than the fire (L) and zero (N) wires.

Make sure that the ground end of the electrical junction box is secured to the wall before installing the product.

If this product is moved from a location with a lower temperature to a location with a higher temperature, condensation moisture may occur. In this case, turn off the unit for several hours.

Do not intentionally soil, spray or clog the cleaning jets.

Do not flush newspapers, diapers, sanitary napkins, or other items that tend to clog the product.

Maintenance work must be carried out by a relevant professional.

Do not use accessories that we have not recommended for use.

1.5 Battery use



If battery acid leaks, do not contact skin, eyes and mucous membranes.

In case of accidental contact with the acid, immediately flush the infected area with plenty of water and seek medical attention immediately.

Keep the battery out of the reach of children. If the battery has been swallowed, seek medical attention immediately.

Do not reactivate the battery with other tools, disassemble it, throw it into a fire, or short-circuit it.

Do not disassemble, expose to fire, or short-circuit the battery.

Remove the batteries from the remote control as soon as they are depleted, otherwise the liquid may leak and cause damage.

Refer to the operating instructions on page 20 for removing and inserting the battery.

Do not subject the battery to extreme conditions: do not expose it to heat sources or expose it to sunlight, otherwise leakage may occur.

1.6 Other safety precautions



Persons (including children) with physical, sensory, or mental impairments, or lack of experience and common sense need to be supervised in the use of this product. This product must be connected to a cold water supply (inlet water temperature approximately 39.2°F to 95°F). Otherwise, it may cause scalding or toilet malfunction.

In the event of an abnormality or malfunction, immediately disconnect the power supply, close the water inlet valve and stop using the product.

Abnormal and malfunctioning conditions such as:

- Product is cracked or broken
- Smoke coming out of the product
- Abnormal sound and burning smell
- Abnormal heating of the product
- Water seeping from piping or inside the product

Continuing to use the product despite a malfunction may result in electric shock, fire, injury, or water seepage from the interior.

Do not stick your fingers or other objects into or block the drying vents.

Failure to do so may result in burns, electric shock or damage to parts.

This product is an electrical product, so do not install it in a place where it is easily exposed to water or high humidity.

Do not splash water or detergent etc. on the product, the bottom of the product and the power plug, otherwise it may cause electric shock, short circuit and fire.



Do not pick up the product by grasping the lid or seat.

Do not open the lid or seat when there is an object on it.

Failure to do so may cause damage to the product, resulting in personal injury.

Do not use adhesive materials such as double-sided tape on the surface of the product. Otherwise, it may cause damage to the surface.



Warning



When using in the bathroom, make sure that the power outlet is waterproof. Failure to use waterproofing may result in electric shock or fire. If the socket is not waterproofed, it may cause electric shock or fire.



No water immersion

Use a splash-proof case and do not pour water or detergent on the main body and power plug. Otherwise, it may result in product damage or fire, electric shock.



Connect the grounding wire

Check that the power outlet is grounded. This product must be well grounded. Connect only to a dedicated 120V(60Hz)15A circuit with a ground fault circuit breaker or grounded earth leakage protector.



Compliance is mandatory

Remove the plug and clean it with a dry cloth. After removing dust from the plug, always insert the mains plug firmly into the socket.

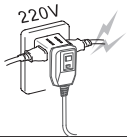

It is strictly prohibited to use too many loads on the same outlet

Only suitable for professional power distribution using AC voltage of 120V (60Hz). Otherwise, it may result in overheating or cause a fire.



Pull out the plug

When not in use for a long time, drain the water inlet hose and unplug it. Otherwise, it may cause water contamination and skin infection.



No high temperature

Do not put lighted cigarettes and other burning materials into the toilet seat. Do not place hot, flammable materials near the product. It may cause a fire.









No disassembly

Do not disassemble or repair or modify this product by yourself for any purpose. It may lead to fire, short circuit and electric shock.



Warning

	<p>ⓘ Compulsory compliance</p> <p>Unplug when thunder strikes. Otherwise, it may cause electric shock.</p>
	<p>⊘ Prohibit</p> <p>Do not use an outlet that is too loose or defective. Failure to do so may result in fire or electric shock.</p>
	<p>⊘ No wet hands</p> <p>Do not plug or unplug the power plug with wet hands. It may result in electric shock.</p>
	<p>⊘ Prohibit</p> <p>Do not pull or damage the power plug / power cord. It may cause fire, short circuit, and electric shock.</p>
	<p>⊘ Prohibit</p> <p>Do not use DC or AC voltage not at 120V. It may cause a product failure.</p>
	<p>⊘ Pull out the plug</p> <p>Disconnect the power and unplug the product before removing or cleaning it. Otherwise, it may cause electric shock or fire.</p>
	<p>ⓘ Compulsory compliance</p> <p>If the power cord is damaged, it must be replaced by the manufacturer or customer service department or professionals to avoid danger!</p>



Attention



Prohibit



Do not bend, twist or damage the water supply hose. Otherwise, it may cause water leakage or insufficient flushing performance of the toilet.



Do not lean on the toilet lid. It may cause damage to the seat cover or personal injury.



Children should not play with this product. Otherwise, it may cause scald, electric shock, fire and personal injury.



Installation Temperature Requirements:
Do not install in areas prone to frost formation. Maintain ambient temperature above 39.2°F at all times. Prevents freezing-induced damage to internal components and systems.



Do not expose this product directly to water, strong light or sunlight. Otherwise, it may cause fading, seat temperature instability.



Do not close the lid and seat with force. Otherwise, it may damage the product.



Do not pour urine on toilet main body and its nozzle. Otherwise, it may result in malfunction or stains such as pink and teal colors.



Do not use the following items to clean this product: gasoline, banana water, benzene, paint thinner, decontamination powder and nylon brush. It may damage the water inlet pipe or the product.



Keep away from the product when using the radio. There may be an interference.



Do not connect to any waste water, mixed water, industrial water, seawater, or other untreated or semi-treated water. It may lead to a skin infection or a malfunction.

Chapter 2 Installation Instructions

2.1 Toilet main body

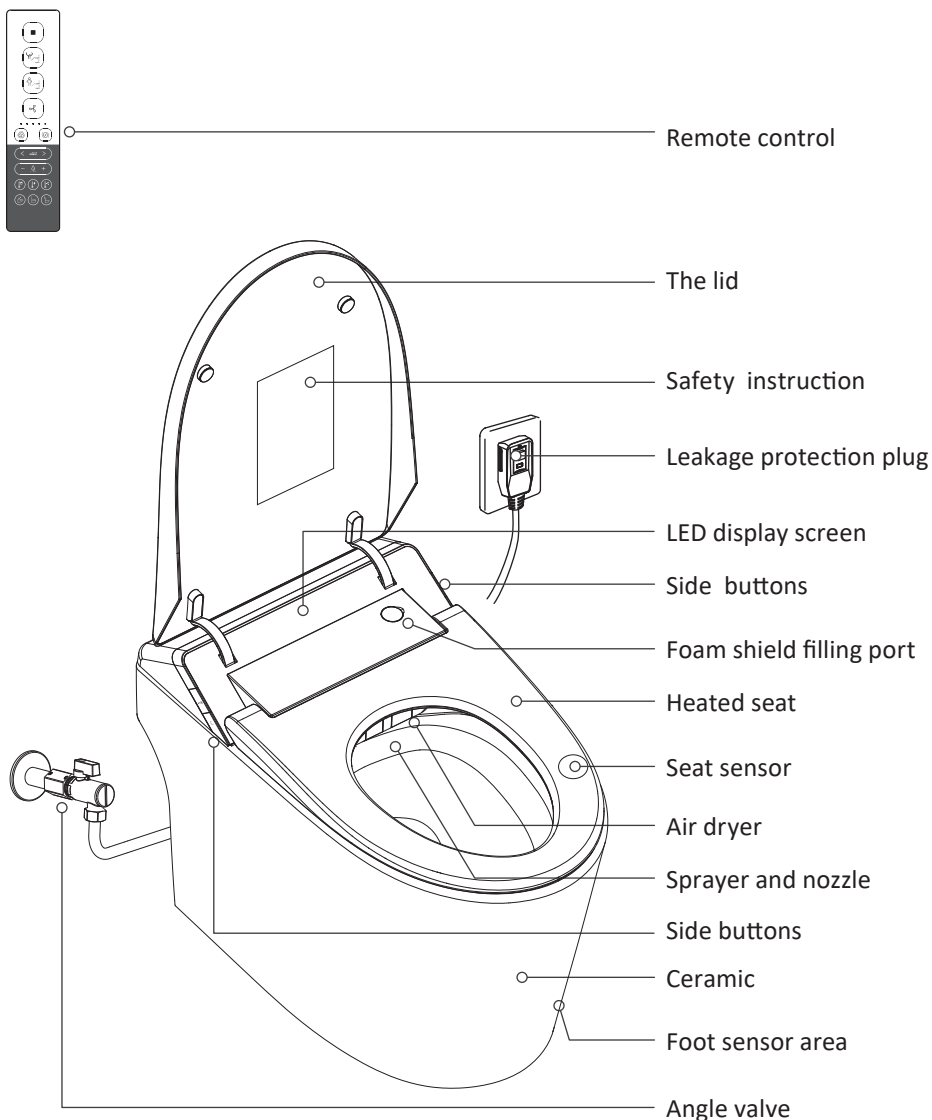

2.2 Remote control key diagram

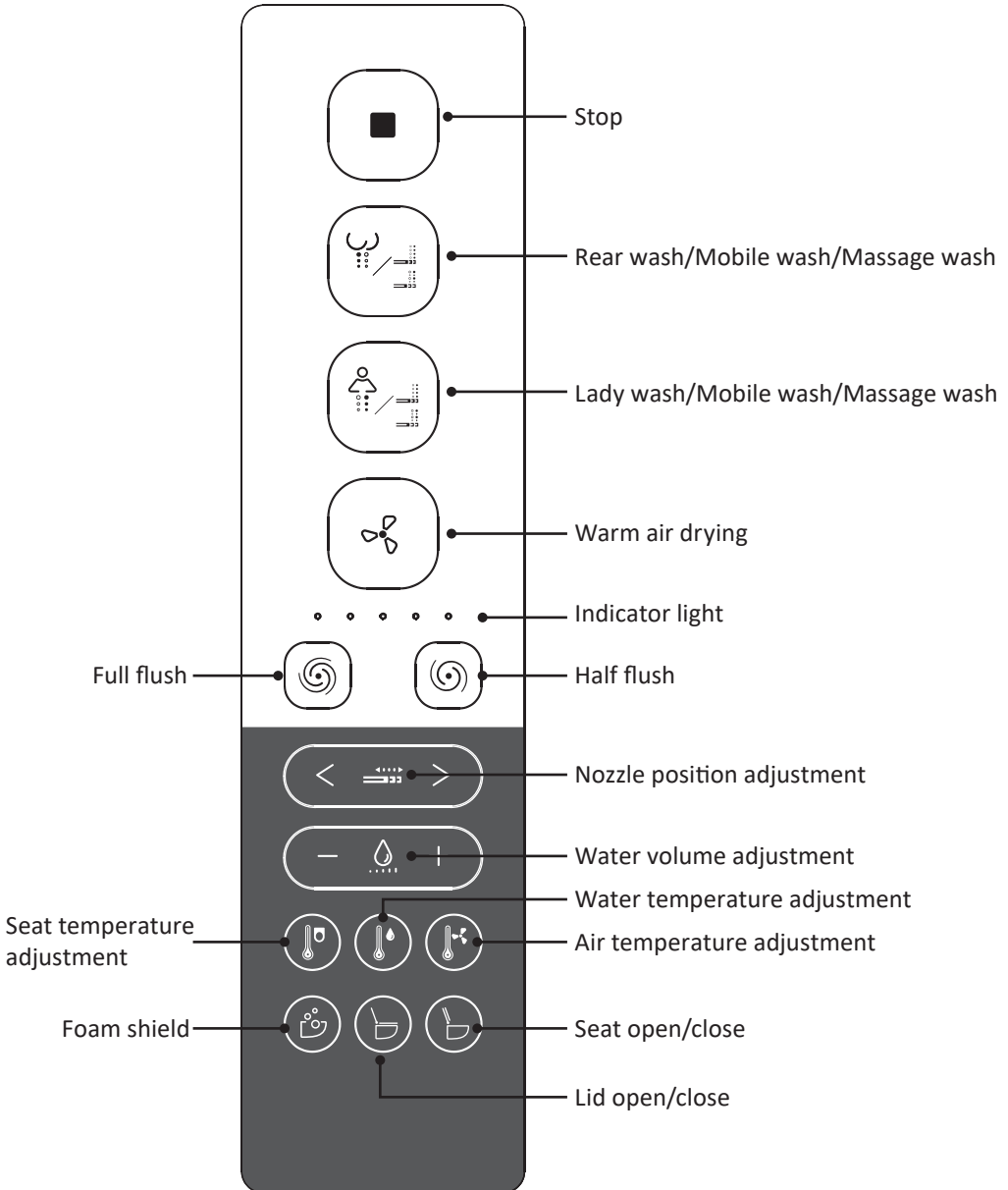





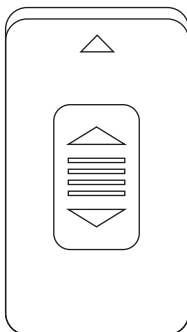



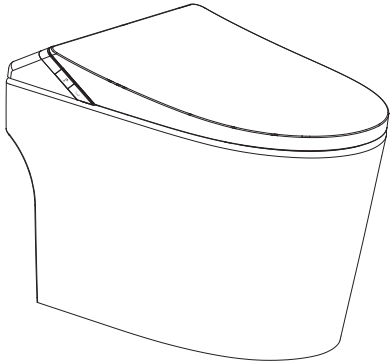

Long press two buttons at the same time to turn on/off some functions.
The details are as follows:

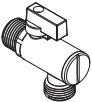
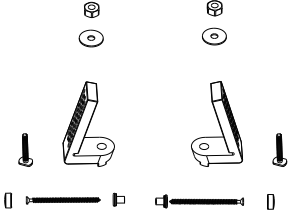
- + ↵ Auto open ON/OFF
- + ↓ Eco mode ON/OFF
- 0 + ↓ Night light ON/OFF
- + ↑ Sound ON/OFF
- + ☺ Auto foam shield ON/OFF
- + ☼ Nozzle clean/replacement
- + Ⓞ Auto flush ON/OFF
- + ↵ Foot sensor ON/OFF
- Ⓞ + ↓ Pre-wet ON/OFF
- ☼ + ↓ Season warmth ON/OFF
- + ☺ Auto deodorization ON/OFF
- + $^{\circ}\text{F}$ and $^{\circ}\text{C}$ switch

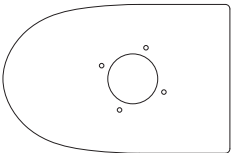

2.3 List of Materials

 <p>Main body</p>		 <p>User manual (1)</p>	
 <p>4*CR123A Battery pack (1) (Batteries excluded)</p>		 <p>Transfer nut and sealing gasket (1)</p>	
 <p>Angle valve(1)</p>		 <p>Ceramic mounting accessories (1)</p>	
 <p>Seal ring (1)</p>		 <p>Foam agent filling funnel (1)</p>	
  <p>Remote control holder (2*AAA batteries excluded) Vertical remote control</p>		 <p>Positioning cardboard</p>	

 Attention of remote control installation

*Please make sure the toilet seat is installed before installing the remote control and pairing the code.

2.4 Important notes for installation

About installation instructions

This installation instruction is used to guide the correct installation of the smart toilet. Please read it carefully before installation.

Signs and its meaning description



Failure to achieve the avoidance of danger will lead to serious injury or even death.



Attention indicates operational practices unrelated to physical harm.

Read the installation instructions in this chapter

This smart toilet device and related water pipes can only be installed by qualified plumbers. Electrical installation can be performed only by qualified electricians.

Safety instructions



Attention Product or performance damage

* Be sure to comply with your country's standards and local installation regulations.



Attention Product damage caused by the water freezing

* It is prohibited to install the smart toilet in a room where there is a risk of frost. The minimum room temperature should not be less than 39.2°F.

* Put the toilet in the room for 24 hours before installing it in a low temperature area.



Attention Product damage caused by water moisture condensation

* When moving the intelligent toilet from a low temperature environment to a high temperature environment, please remove the power supply for a few hours.

Do not remove separate components.



Dangerous Fatal electric shock hazard!

* If the power cord is damaged, it must be replaced by the manufacturer's maintenance personnel or professionals.

* Appliance must be properly grounded.

* The fixed wiring shall be equipped with anti-shock switch according to the wiring rules and provide over voltage level III with full pole disconnection.

* The power line for fixed wiring is of a nominal cross-sectional area of 1-2.5 square mm.

* Determine that the ground end of the power supply line is 10 mm longer than the fire line (L) and zero line (N).



Attention

* All length units in this installation instruction are millimetre (mm).

* This product should be permanently connected to the water pipe. Do not remove the water pipe assembly except for installation and maintenance.

2.5 Product installation

■ Matters need attention

1. This product has an AC voltage of 120V(60Hz) and a rated power of 1050W. This product is limited to the specified power supply.
2. The length of the power cord $\geq 1\text{m}(39.37\text{ in})$; power outlet should be close to the location of the product installation and removal.
3. Water inlet water pressure range 11psi-108psi; please follow the instructions.
4. Ambient temperature range 39.2°F-104°F, humidity range $\leq 95\%$; please use according to instructions.
5. The inlet pipe is 0.7m(27.56 in) long; the valve should be close to the location where this product is installed and removed.
6. In the same room where this product is installed, a water stop valve needs to be installed within reach. In case of emergency, you can cut off the water inlet of the product without tools. Otherwise, the accidental failure of the product may lead to the loss of the user.
7. After the product is installed, connect the power supply and water supply.



Prohibit

Do not use the product if the power cord or plug is damaged, or if the plug is loose. It may cause electrocution or fire.

■ Product size

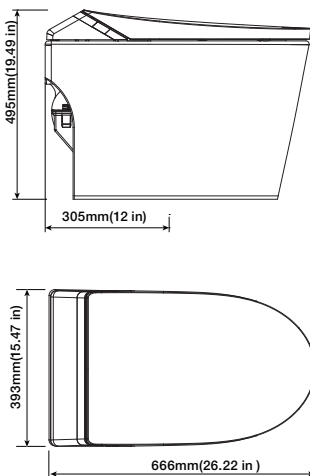

■ Reference drawing of the inlet and drainage position



With ground fault circuit breaker and water and splash proof 15A socket

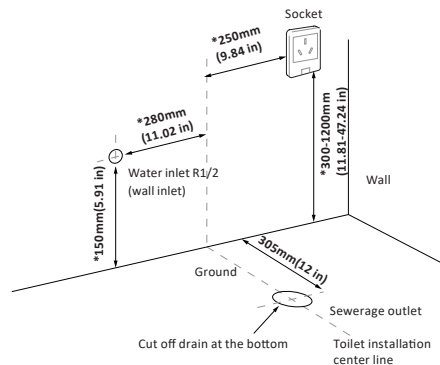

Attention: Before install the angle valve, drain the gravel and other impurities from the water inlet pipe.

■ Install the adaptor nut and the angle valve

Wrap teflon tape around the threads of the inlet and angle valves. Insert sealing gaskets on both sides of the adaptor nut, with the N end facing the inlet outlet and the G end facing the angle valve outlet.

Replace the existing angle valve with our angle valve to ensure optimal performance of the toilet. To ensure proper installation, ask a professional plumber to install the valve.

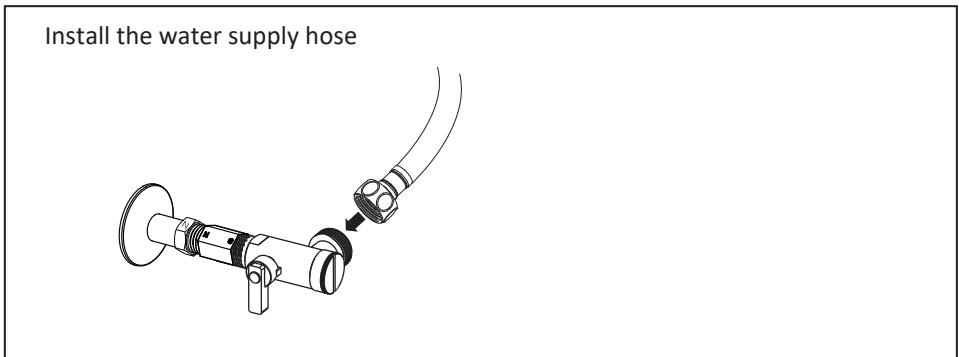
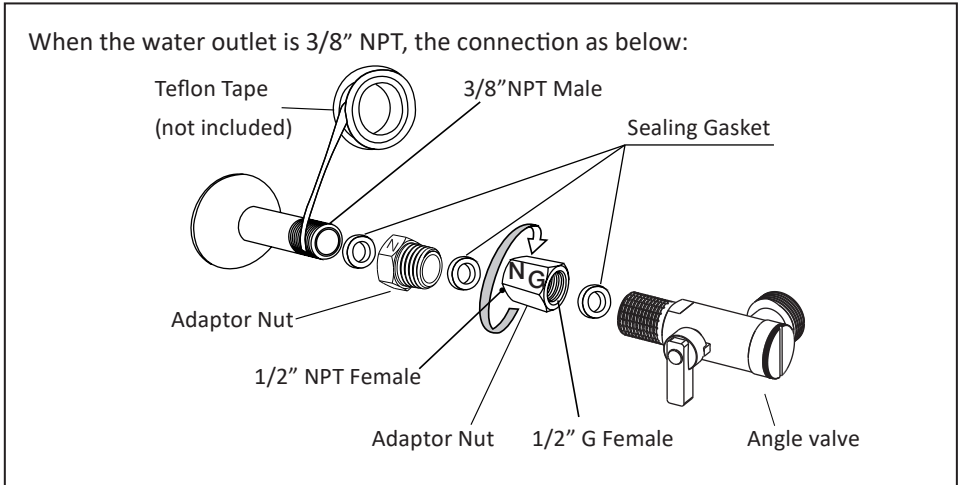

■ Fixed seals with mounting products

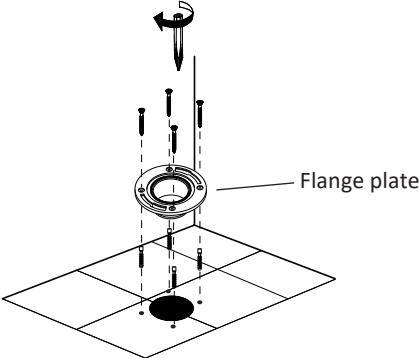
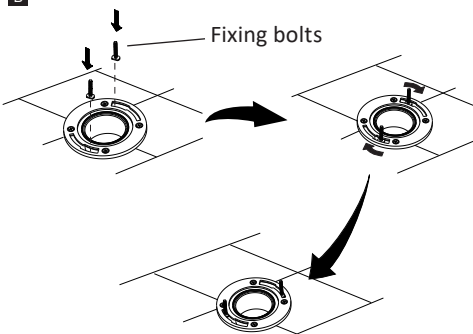
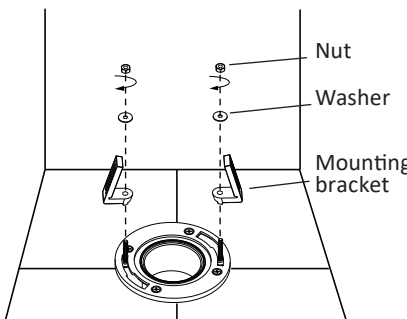
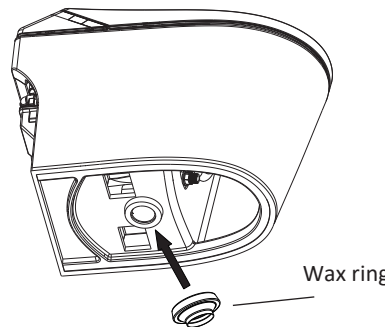
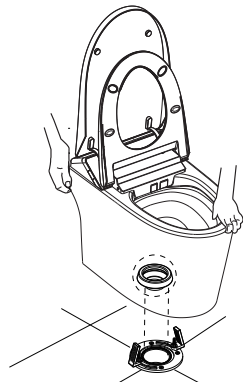
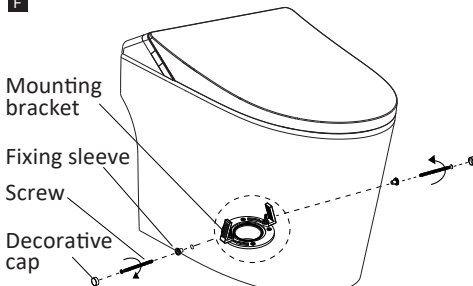
<p>A</p>  <p>Flange plate</p> <p>Install the flange plate.</p>	<p>B</p>  <p>Fixing bolts</p> <p>Position correctly the two fixing bolts of the flange.</p>
<p>C</p>  <p>Nut</p> <p>Washer</p> <p>Mounting bracket</p> <p>Assemble the mounting bracket with bolts and then install them to the pre-installed flange plate on the ground and lock tightly with nuts.</p>	<p>D</p>  <p>Wax ring</p> <p>Insert the wax ring under the drain hole.</p>
<p>E</p>  <p>Mounting bracket</p> <p>Fixing sleeve</p> <p>Screw</p> <p>Decorative cap</p> <p>Position the toilet on the floor drain, making sure the flange plate are aligned with the wax ring.</p>	<p>F</p>  <p>Mounting bracket</p> <p>Fixing sleeve</p> <p>Screw</p> <p>Decorative cap</p> <p>Put the screw through the fixing sleeve and then install it through the holes (on both sides of the ceramic toilet) to the mounting bracket on the ground, and lock tightly with a tool, put the decorative cap on the fixing sleeve.</p>

■ Turning on the power

1. Install the 120V (greater than 15A) socket more than 300mm(11.81 in) from the ground.
2. Install the socket in a place where water will not easily splash into it.
3. Use a grounded outlet.
4. Insert the product's power plug into



Attention

Put the screw through the fixing sleeve and then install it through the holes (on both sides of the ceramic toilet) to the mounting bracket on the ground, and lock tightly with a tool, put the decorative cap on the fixing sleeve.



Warning

Please connect the power supply according to the product power supply requirements. Otherwise, it may cause product failure.



■ Installing the remote control

Try to install the remote control as close to the toilet as possible, choosing the right height on the wall.

Method 1

1. Tear off the 3M adhesive protective film.
2. Stick the remote control holder to the wall in a suitable position (It is recommended to stick it to tile or wood board type wall).
3. Mount the remote control on the remote control holder.

Mode 2: As shown in the picture

The size marked with "*" is the recommended size, both left and right are acceptable.

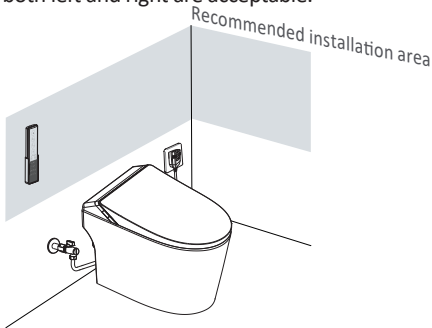

Warning

1. Do not spill water on the remote control, or it may cause the product can not be used normally.
2. When not in use, please place the remote control on the holder.
3. The remote control may malfunction or be damaged if dropped.

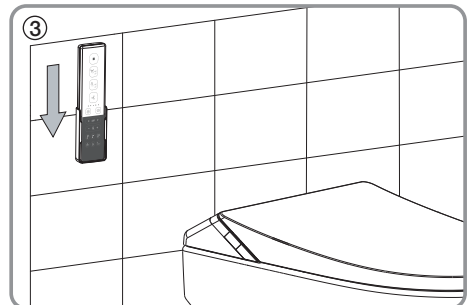
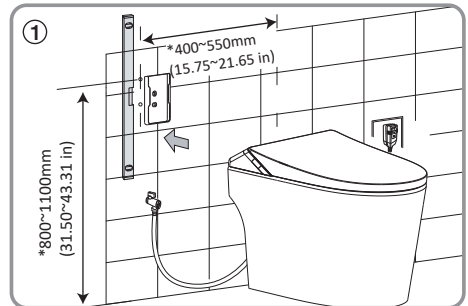

■ Connect the backup battery pack

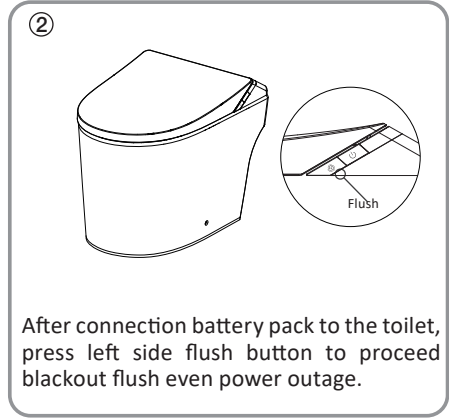
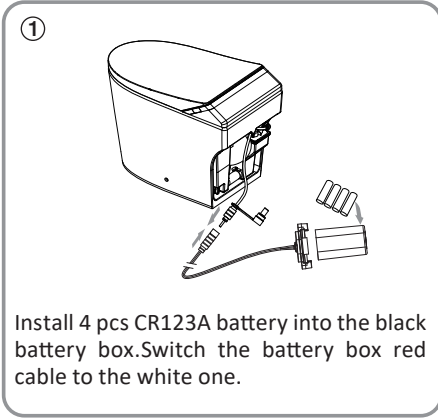

Chapter 3 Operating Instructions

Preparation and confirmation before use

■ Open the valve

Before turning on the power, open the water inlet valve to supply water for the toilet.

■ Confirmation and commissioning

1. Check the power supply

Confirm that the power plug has been plugged in tightly inserted, the plug indicator light indicates that it has been energized. If the indicator is not lit, press the plug's 'reset' button to power up.

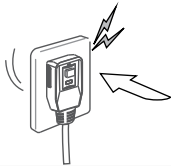

2. Seat sensor

The seat sensor area has been labelled on the seat. The functions of intelligent toilet will only activate when someone is sitting on the seat.



3. Check the flush button function

Press the flush button on the left side of toilet to see if it flushes normally.

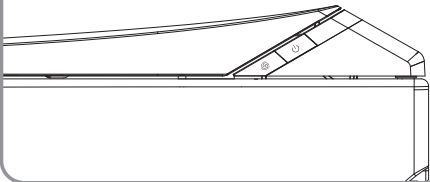

4. Check the cleaning function

Sit on the toilet and press the rear wash button to see whether the nozzle extends and start working. Press the power button to close washing function.

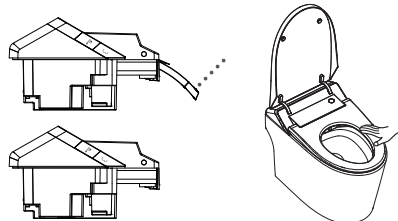

3.1 Initialization operations

a. Open the water inlet valve and make sure the tap water is connected.

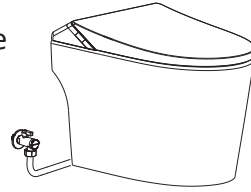

b. Method of foaming agent filling:

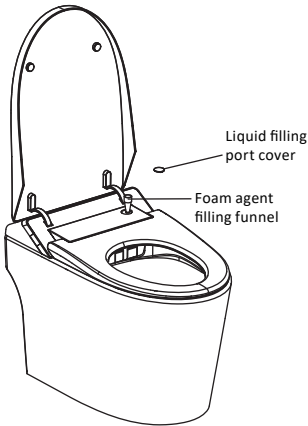

1. Open the lid. 2. Pick up the foam shield filling port cover. 3. Place the foam agent filling funnel on the liquid filling port. 4. Pour the special foaming agent into the liquid filling port until the foaming agent is visible and overflows to the water cover. 5. Reset the lid of the liquid filling port. 6. Then long press the remote control "foam shield" button 3 seconds, you will hear a beep sound. At this time, toilet will be replenished with liquid, and foam once after replenishment is completed. 7. Automatic foaming: under the state of leaving the seat, press the "stop" button and "foam shield" button on the remote control at the same time. If you hear a beep sound which means automatic foaming function is opened. If you hear two beep sounds which means automatic foaming function is closed.

Note: In order to achieve the best foaming effect, foaming agent specialized for toilet is recommended. If it is unavailable, you can only fill the neutral dish-washing liquid. Do not use toilet cleaners, chlorine cleaners, lemon-based cleaners, gel cleaners, dishwasher detergents or mix multiple types of cleaners. If foam is spilled during refilling, wipe up immediately with clean water.

c. Install batteries for the remote control:

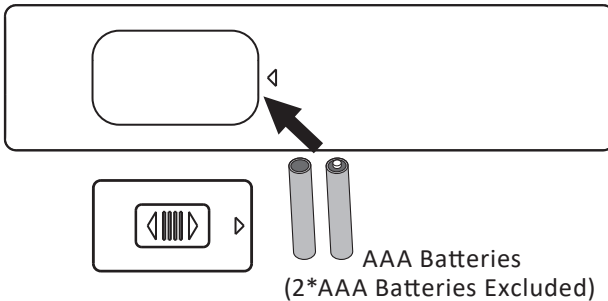

※Used batteries should be disposed of in the appropriate type of trash can.

Try to operate the remote control, if the indicator light of the remote control lights up with the keys, that means the battery is installed successfully. If the remote control does not work, please check if the batteries are charged and installed correctly. If the batteries are used up, you can reinstall new batteries in the above way.

To prevent the battery from breaking or leaking, be sure to observe the "Precautions for Use". (in page 4)

d. Remote control code matching

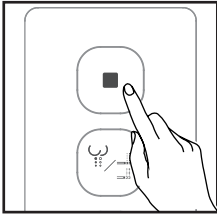

1. Power off the toilet, long press the remote control "■" button, the indicator light flashes.

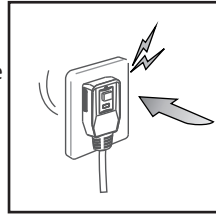

2. Power on the toilet, you will hear a long sound, which means the code is successfully matched.

After power on, the system will self-test, and the self-test will be completed after about 20 seconds.

If the code matching is unsuccessful, the indicator light of the remote control will go out automatically after 30 seconds, you can try again with the above steps.

If still unsuccessful, please contact the customer service.

3.2 Operation instructions of toilet side buttons

Right side buttons

Seat temperature adjustment/Nightlight

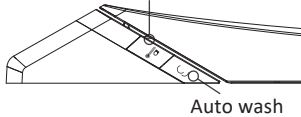

Auto wash

Left side buttons

Power

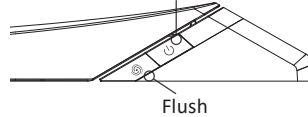

Flush

Seat temperature adjustment/Nightlight: Short press "🪿" to adjust the temperature of seat. The temperature of seat is divided into 5 levels and room temperature, cycling in turn, the highest is the 5th level. Long press "🪿" to turn on or turn off the nightlight.

Auto wash: When people is sitting on the seat, short press this button to start auto rear wash, the procedure is 15s →fix wash→ 45s mobile wash→ full flush once→ 2 minutes air dry. Long press this button to start auto lady wash, the procedure is same as auto rear wash. The washing process will stop automatically after 3 minutes. Or press the "🪿" side button or "■" button on remote control to stop the current work.

Power button: Short press to stop the function of rear wash/lady wash/drying etc; Long press to enter the standby mode, short press to exit.

Flush: Short press this key to execute full flush, long press this key for half flush.

3.3 Operation instruction of remote control

Operated the remote control, it can control rear wash, lady wash, drying and flushing, including position, water volume, air temperature, water temperature, seat temperature setting and other functions. Pressing the corresponding buttons on the remote control can stimulate the corresponding functions. Each time you operate the button indicator light will flash once.

In any case, stop is the key with the highest priority response. If the remote control is not available, please check whether it has been code-matching or if there is a battery power problem.



Rear wash/Mobile wash/Massage wash

(The function only works when people is sitting on the seat)

1 Press the "☹" button, the water will come out from the front of the nozzle and for the fix wash. Press it again to enter the mobile wash. Press it again to enter the massage wash. Press it again to enter the fix wash, and so on.

2 During the washing process, press the "■" button or the "☹" side button to stop washing. Or wait for 3 minutes later, rear wash will completed and stop automatically.

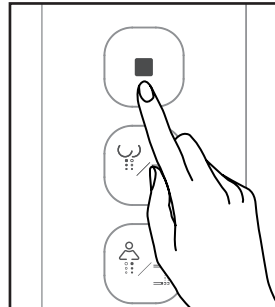
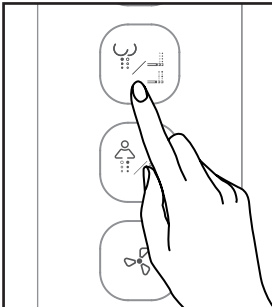



Lady wash/Mobile wash/Massage wash

(The function only works when people sited on the seat)

- 1 Press the "👤" button, the water comes out from the front of the nozzle and do the fix wash. Press it again to enter the mobile wash. Press it again to enter the massage wash. Press it again to enter the fix wash, and so on.

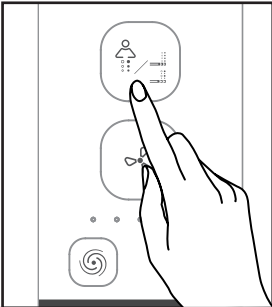

- 2 During the washing process, press the "■" button or the "⏸" side button to stop washing. Or wait for 3 minutes, lady wash will completed and stop automatically.

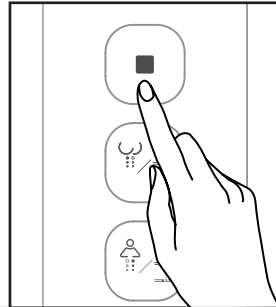

Warm air drying (5 level adjustable)

(The function only works when people is sitting on the seat and washing function is not executed)

- 1 Short press the "🌀" button to activate the drying function (the system will do the flush first before the warm air comes out).

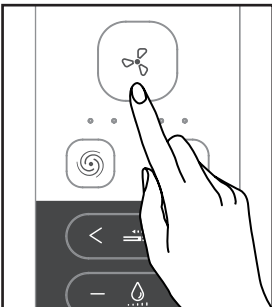

- 2 During drying, press the "■" button or the "⏸" side button to stop drying. Or wait for 3 minutes, drying will be completed and stop automatically.

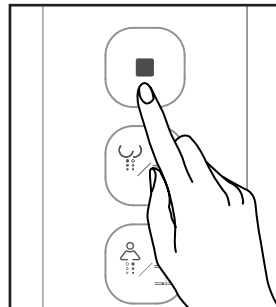



Flush button

- 1** Press "⌀" button to activate full flush once.



- 2** Press "⌀" button to activate half flush once.

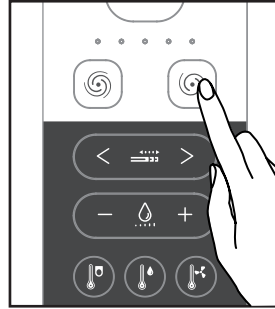

Nozzle position (5 levels adjustable)

- 1** Press the "<" button, the nozzle retracts backward, there are two beep sounds when it is in a minimum level.

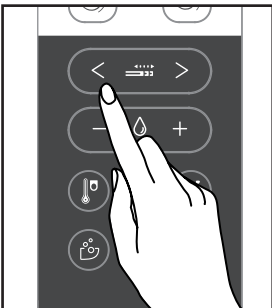

- 2** Press the ">" button, the nozzle extends forward, there are two beep sounds when it is in a maximum level.

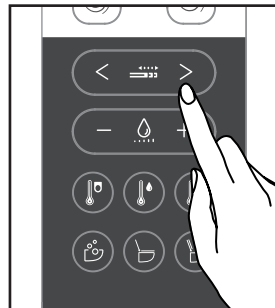



Water volume adjustment (5 levels adjustable)

- 1 Press the "-" button, water volume is reduced, there are two beep sounds when it is in a minimum level.



- 2 Press the "+" key, water volume is increased, there are two beep sounds when it is in a maximum level.

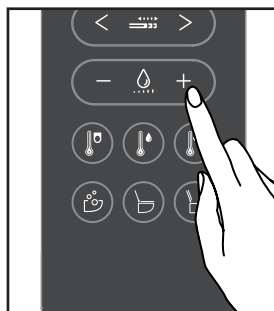

Seat temperature adjustment (5 levels adjustable)

- 1 Press the "🌡️" button to change the seat temperature. The seat temperature is divided into 5 levels and room temperature. Cycle in sequence, the highest is the 5th level, the indicator lights all go out at room temperature.

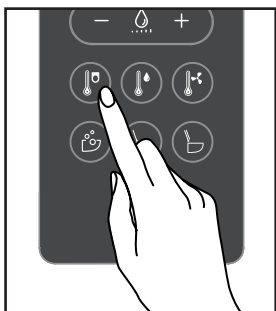



Water temperature adjustment (5 levels adjustable)

- 1 Press the "🌡️💧" button to change the water temperature of rear wash and lady wash. The water temperature is divided into 5 levels and room temperature. And the setting range is 87.8°F-102.2°F. Cycle in sequence, the highest is the 5th level, the indicator lights all go out at room temperature.

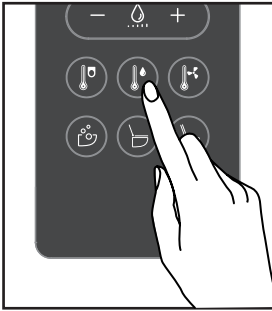

Air temperature adjustment (5 levels adjustable)

- 1 Press the "🌡️🌀" button, you can change the air temperature in the drying mode. The air temperature is divided into 5 levels and room temperature. Cycle in sequence, the highest is the 5th level, the indicator lights all go out at room temperature.

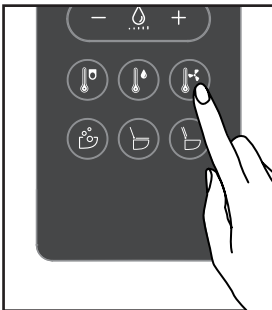



Foam shield

- 1 Press the "☺" foam shield button to execute the foaming function once, and long press the foam shield key to execute the replenishment function in the off-seat state.

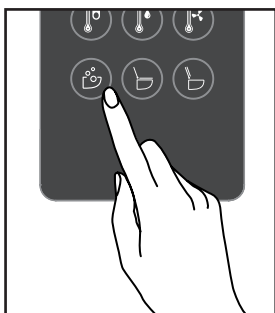

※Press the "■" button and "☺" button at the same time to turn on/off the automatic foaming function. There is one beep when turned on and two beeps when turned off.



Lid/seat open and close function

- 1 Press "☺" button to open or close the lid.
- 2 Press "☺" button to open or close the seat.

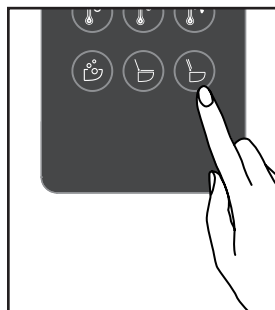
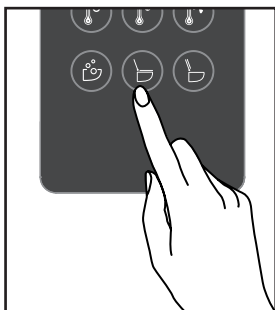

LED screen display

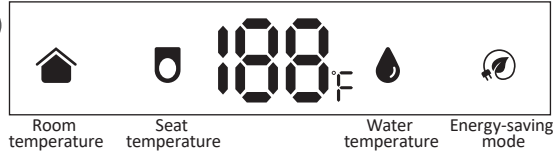

The above functions correspond to the remote control settings one by one, and the original setting is displayed as seat temperature. When the seat temperature function is off, the LED screen displays as -- F

Automatic deodorization function

When seated, the deodorizing fan is activated and automatically shuts off one minute later when you leave seat.

Auto flush function

When sit more than 5s, 6s after leaving the seat, the toilet will flush automatically.
※Press the "■" button and "⊙" button on remote control at the same time to turn on / off the automatic flushing function. There is one beep sound when it is turned on, two beep sounds when it is turned off.

UV sterilization function

When people leaves the seat, the UV sterilization function is activated and automatically switched off after one minute.

Power off flush function

Battery pack use please refer to page 17.

When power off for emergency, press the flush side button to execute the flush function (only when the backup battery pack is connected).

Auto Open/Foot Sensor Lid & Seat Open

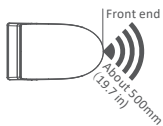

A fan-shaped sensing area is located near the front of the toilet, with a radius of about 500 mm (19.7 in) and a 90-degree angle.

-Open the lid when it detects a person approaching.

-Men use the foot sensor to open the seat before urinating, and use the foot sensor to flush after urinating.

-If the lid is open, it will automatically close 90s after the user leaving the toilet.

-The sensing area will be deviated according to the height and the installation position of the intelligent toilet.



-Press the "■" button and "⊙" button on remote control at the same time, you can turn on/off the automatic lid opening function. There is one beep when turn on and two beep sounds when turn off.

Even auto open lid function is off via reomote control, foot sensor operation is available to open the lid.





Remote Control Compound Key Description



Auto open ON/OFF

The default setting of auto open is ON. The auto open function can be switched to ON and OFF by pressing "  " + "  " at the same time. One beep sound can be heard when it is ON, two beep sounds can be heard when it is OFF.



Eco mode ON/OFF

The default setting of Eco mode is OFF. The energy saving mode function can be switched to ON and OFF by pressing "  " + "  " at the same time. One beep sound can be heard when it is ON, two beep sounds can be heard when it is OFF.



Night light ON/OFF

The default setting of night light is ON. The night light function can be switched to ON and OFF by pressing "  " + "  " at the same time. One beep sound can be heard when it is ON, two beep sounds can be heard when it is OFF.



Sound ON/OFF

The default setting of sound is ON. The sound can be switched to OFF by pressing "  " + "  " at the same time. One beep sound can be heard when it is ON, two beep sounds can be heard when it is OFF.



Auto foam shield ON/OFF

The default setting of auto foam shield is ON. The auto foam shield function can be switched to ON and OFF by pressing "  " + "  " at the same time. When it is at OFF status, it means that it has been switched to manual mode and you can have foam shield function only when you press "  " button. When it is at ON status, it means that it is on auto mode. Every time you sit on the seat, it will auto activate the foam shield.



Nozzle clean/replacement ON/OFF

Press "  " + "  " at the same time, you will see the nozzle sprayer extends out without water, you can do the nozzle clean/replacement at this time. Press any button on the remote control, the nozzle will withdraw back. One beep sound can be heard when it is done successfully.



After flush ON/OFF

The default setting of auto flush is ON. The auto flush function can be switched to ON and OFF by pressing "  " + "  " at the same time. One beep sound can be heard when it is ON, two beep sounds can be heard when it is OFF.



Foot sensor ON/OFF

The default setting of foot sensor is ON. The foot sensor function can be switched to ON and OFF by pressing "  " + "  " at the same time. One beep sound can be heard when it is ON, two beep sounds can be heard when it is OFF.



Pre-wet ON/OFF

The default setting of pre-wet function is ON. The pre-wet function can be switched to ON and OFF by pressing "  " + "  " at the same time. One beep sound can be heard when it is ON, two beep sounds can be heard when it is OFF.



Seasonal warmth ON/OFF

The default setting of seasonal warmth is OFF. The function can be switched to ON by pressing "  " + "  " at the same time. One beep sound can be heard when it is ON, two beep sounds can be heard when it is OFF.

Auto deodorization ON/OFF

The default setting of auto deodorization function is ON. The function can be switched to ON and OFF by pressing "  " + "  " at the same time. One beep sound can be heard when it is ON, two beep sounds can be heard when it is OFF.

°F and °C switch

The °F and °C showed on screen display can be switched by pressing "  " + "  " at the same time. One beep sound can be heard when it is switched successfully.

Chapter 4 Cleaning and Maintenance

4.1 Toilet seat cleaning

Clean the toilet regularly or as soon as it becomes soiled. If cleaning is not carried out regularly, dirt may become more visible and become stubborn.

Be sure to turn off the power before cleaning the surface of the product.

Do not touch the inside of the product or the power plug with liquids such as water or detergent, as this may cause a short circuit or electric shock, fire.

Note that improper cleaning may result in yellowing of colors or peeling of paint.

-- Do not use aggressive doses of detergents or cleaning agents containing chlorine or acid.

-- Use only cleaners and equipment specifically designed for this application.

-- Follow the cleaner product instructions.

-- Never mix cleaning agents.

Wipe with a soft cloth soaked in water and wrung out. Neutral soap is the ideal daily cleaner.

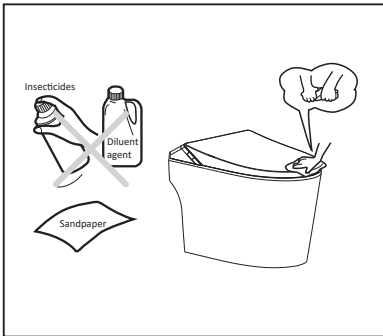

Cleaning the external parts of the product

- Please use a sponge or soft cloth with room temperature water or neutral cleaner to wipe the surface of the product.
- Lift up the lid and seat when cleaning other parts with detergent.
- Wait until the cleaner in the ceramic toilet seat is completely rinsed out before close the lid, otherwise the evaporation of the cleaner may corrode the surface.

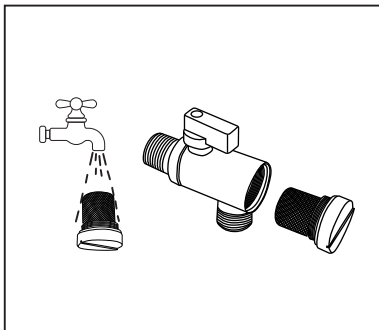

Cleaning the filter

- Disconnect the power, close the angle valve, then spin out the filter on the angle valve, remove the filter and then rinse under the faucet to clean the impurities.
- Clean the filter when the water flow is smaller than normal.
- After cleaning, put the filter back.

4.2 Sprayer and nozzle cleaning

The retracted nozzle is automatically cleaned before and after using the cleaning function.

- Clean the nozzles of the spray tube regularly or as soon as dirt is found.

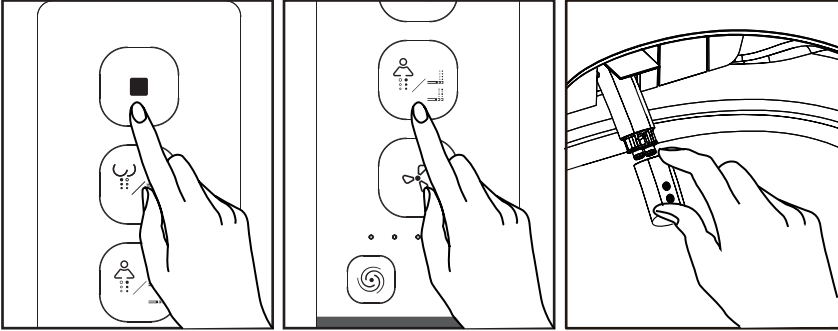

a. Press the remote control "■" button and "👤" button at the same time, the cleaning sprayer extends without water and the nozzle can be replaced or cleaned.

b. Remove the nozzle and clean the nozzle with a cloth, sponge or brush and a neutral detergent.

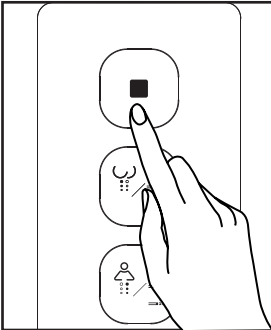

c. Put the cleaned nozzle back and click the "■" button on the remote control, the sprayer and nozzle retracts.

4.3 Remote control cleaning

Use a soft cloth to clean the remote control and the remote control holder.

4.4 Waste disposal

Electrical and electronic equipment may contain hazardous or harmful substances. Do not dispose of them as unsorted household waste. Take it to a designated recycling point. In this way, you can contribute to resource conservation and environmental protection. Contact your retailer or local authorities for more information.

Used batteries must be disposed of correctly. For this purpose, battery recycling bins with the appropriate labels are provided in stores selling batteries and at community collection points.

To avoid possible choking injury or danger, do not allow children to play with the plastic bag and product packaging. Please keep such packaging materials in a safe place or recycle them in an environmentally friendly manner. If possible, keep the packaging materials until the end of the warranty period.

4.5 Product maintenance

Close the angle valve and remove the hose to drain the water in the following cases.

- When water may freeze in cold areas.
- When not in use for a long period of time.

Otherwise, the residual water may deteriorate and cause skin infections.

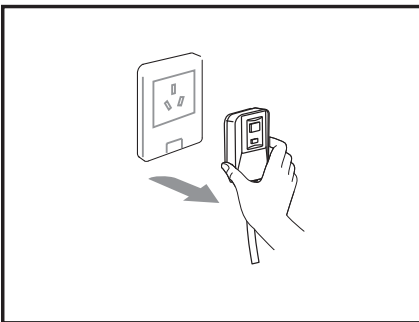

a. Disconnect power and pull out power plug.

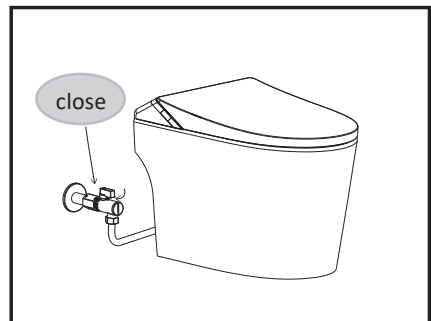

b. Close the angle valve to stop water supply to the system.

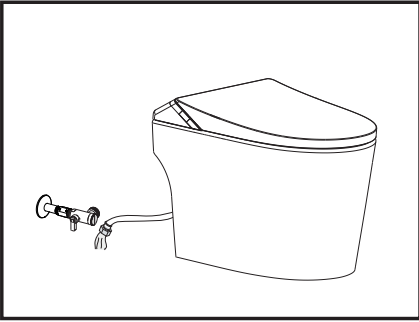

c. Remove the water inlet hose from the angle valve and drain the water.

4.6 Product maintenance in winter

When freezing may occur, such as in winter, take precautionary measures to prevent damage to hoses or products due to freezing.

To prevent damage to hoses or products due to freezing, take precautions against freezing:

1. Raise the room temperature.
2. Close the angle valve and drain the water inlet hose.

Chapter 5 Troubleshooting

Recommendations: Initial basic operation in case of malfunction.
 Disconnect the mains power to the toilet and reconnect it after at least 3 minutes.
 If it does not work properly after following the instructions described below,
 contact customer service center or distributor.

Issue	Possible cause	Solution
Basic function		
Product not working	Is power supply turned off?	Turn on the power supply.
	Is loose socket or poor contact?	Please re-plug and ensure that the power supply is restored.
	Is power button did not pressed?	Press the power button for the toilet.
	Is it in standby mode?	Switch to the open mode.
Water leakage	Malfunctions	Close the main water supply. Turn off the power. Call the customer service.
Remote control		
Remote control icon flashing during operation (not always on)	Low battery power?	Replace with new batteries.
Remote control doesn't work	Low battery?	Replace with new batteries.
	Did the battery run out?	Replace with new batteries.
	Does the positive and negative pole of the battery set correctly?	Reset the batteries in the correct direction.
	Is the remote control defective?	Call the customer service.



Warning

**Do not disassemble, repair or modify the toilet by yourself.
 It may cause electric shock, fire or malfunction.**

Issue	Possible cause	Solution
Rear wash/lady wash		
It takes too long to switch from rear wash and lady wash	The nozzle needs the time to do the self-clean when switch from rear wash to lady wash	This is normal phenomenon.
Nozzle does not extend after pressing the “rear wash”or “lady wash” buttons	Inlet hose bending cause blockage?	Check the inlet hose and make sure it is not bend. If it still not working, call the customer service.
Nozzle extends without water	Is water supply cut off ?	Open the water supply.
	Is the angle valve closed or stop by impurities?	Open or clean the angle valve.
	Inlet hose bending cause blockage?	Check the inlet hose and make sure it is not bend. If it is still not work, call the customer service.
	Is the nozzle blocked?	Wash the nozzle.
Nozzle come out water disorderly	Abnormal operation or toilet malfunction.	Pull out the plug, reconnect after one minute and restart the toilet. If it is still not work, call the customer service.
The water volume is too weak	Is water volume set on the lowest setting?	Reset the water volume on a higher setting.
	Is cleaning nozzle blocked?	Clean the nozzle.
	Is the inlet water filter screen blocked?	Clean the filter in angle valve.
	Is the water hose deformed?	Call the customer service
Water temperature is not warm enough	Is water temperature set to “off” or on the lowest setting?	Reset the water temperature on a higher setting.
The water temperature is too high	Is water temperature set on the highest setting?	Reset the water temperature on a lower setting.
The nozzle suddenly stopped spraying water	User left the seat. Or the nozzle will move back automatically after 3 minutes wash.	This is normal phenomenon.
The retraction nozzle is dripping	The nozzle is do the self clean automatically when switch from rear wash to lady wash.	This is normal phenomenon.

Issue	Possible cause	Solution
Warm air drying		
Drying function does not work	Is the seat sensor being contacted?	Sit on the seat sensor again and press drying button.
Drying temperature is too high	Is drying temperature set to "off" or on the lowest setting?	Reset the drying temperature on a higher setting.
Drying temperature is too high	Is drying temperature set on the highest setting?	Reset the drying temperature on a lower setting.
Deodorization		
It is too loud when deodorization function is working	Is dust clogged in deodorization device?	Clean the deodorization device or call the customer service.
Open / close the lid or seat		
Lid and seat can not open/close by remote control	Disorder software or damaged components	Restart the toilet. If it did not work, contact the customer service.

■ Malfunction indication

Failure Type	Failure Condition	Failure Phenomenon	Failure Clear	Failure Indication
Water flow	After the water inlet valve is opened, the flow meter feedback flow rate is small.	Water temperature does not heat or nozzle withdraw back, and the rest of the functions work normally.	After the flow rate returns to normal.	The display shows the E1 and flash for 120 seconds.
Water- inlet temperature sensor	Faulty water temperature sensor or abnormal temperature.	Water temperature does not heat or nozzle withdraw back, and the rest of the functions work normally.	The inlet water temperature sensor is repaired or the temperature returns to normal.	The display shows the E2 and flash for 120 seconds.
Water outlet temperature sensor	Faulty water temperature sensor or abnormal temperature.	Water temperature does not heat or nozzle withdraw back, and the rest of the functions work normally.	The outlet water temperature sensor repairs or the temperature returns to normal.	The display shows the E2 and flash for 120 seconds.
Air temperature sensor	Faulty air temperature sensor or abnormal temperature.	Air temperature does not heat , and the rest of the functions work normally.	The air temperature sensor repairs or the temperature returns to normal.	The display shows the E3 and flash for 120 seconds.
Seat sensor	Faulty seat temperature sensor or abnormal temperature.	The seat does not heat , and the rest of the functions work normally.	The seat temperature sensor is repaired or the temperature returns to normal.	The display shows the E4 and flash for 120 seconds.

It is important to contact customer service when any of the following occurs.

- The indicator light on the toilet is still blinking after 30 seconds of being re-plugged in (Please unplug the power supply).
- The indicator light on the toilet does not light up after 30 seconds of being re-plugged in.
- When smoke or abnormal sound occurs. (Please unplug the power supply).
- When warm air does not come out, or when the warm air suddenly becomes cold during use of the warm air function, it does not return to normal after re-plugging the power supply.

Chapter 6 Technical Data

Product model		IS-D10PRO,ID-V010PRO		
Rough-in Size		305mm(12 in)		
Rated voltage		AC 120V (60Hz)		
Power rating		1050W		
Nominal water consumption		Large <4.8L / small <3.5L		
Suitable environment		39.2° F-104° F, 95% relative humidity		
Power cord		≥1m(39.37 in)		
Cleaning	Water pressure		11psi-108 psi(Static pressure)	
	Water inlet temperature		39.2°F-95°F	
	Warm water heating method		Instant	
	Cleaning method		Rear and lady wash / Mobile wash/ Massage wash	
	The nozzle position	Rear wash	5 levels adjustable	
		Lady wash	5 levels adjustable	
	Safety device		Temperature fuse wire, temperature controller	
Seat	Seat temperature		5 levels+Room temp	
	Safety device		Temperature sensor and temperature fuse	
	Open&close		Sensor or remote control	
Drying	Minimum air volume		0.2m ³ /min	
	Dry cycle		3 minutes	
	Warm air temperature		5 levels adjustable+Room temp	
	Safety device		Thermo controller, temperature fuse	
Deodorization method		Cold catalyst		
Other safety device		Leakage protection		
Net weight		39. 6 Kg/87.3 lbs (Including ceramic)		

Note: Rated power is the average power that under the conditions of ambient temperature of 71.6 ° F ± 1.8 ° F, inlet static pressure of 30psi ± 3psi, inlet water temperature of 59 ° F ± 1.8 ° F, turn on the rear wash function and set the water flow, seat temperature and water temperature to the highest level successively, then start rear/lady wash function immediately, record the average power for 60 seconds as the rated power value of the unit.



Get free technical support for the lifetime of your product.

Email: service@ihatit.com

Phone: (+1) 702 610 2950