

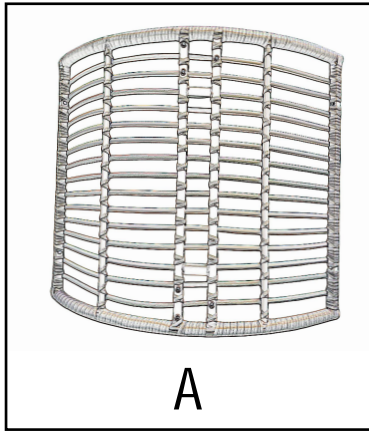

**Warning:**

Be careful not to cut the seat cushion if you need to open the package

Part List:



A

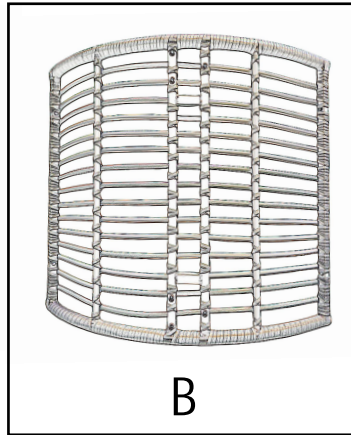

B

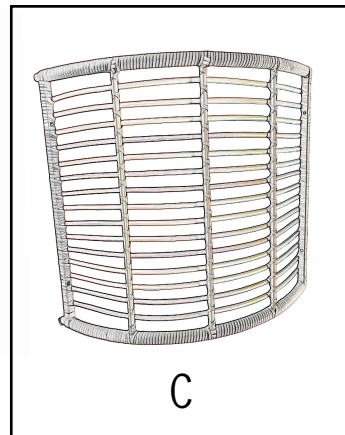

C

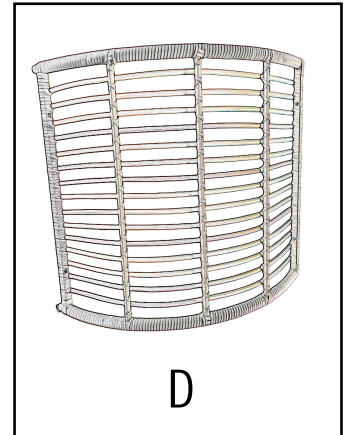

D

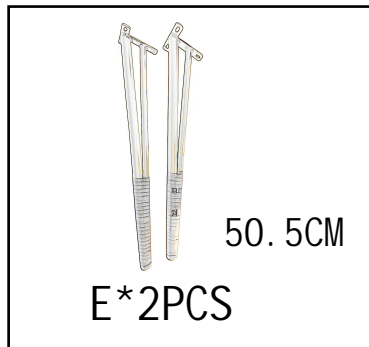

50.5CM

E\*2PCS

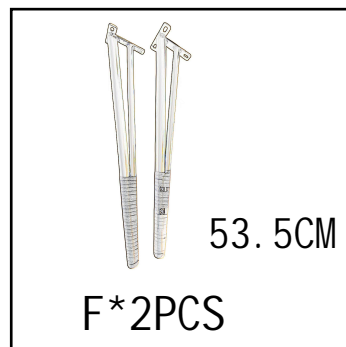

53.5CM

F\*2PCS

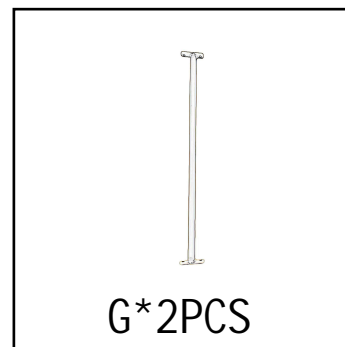

G\*2PCS

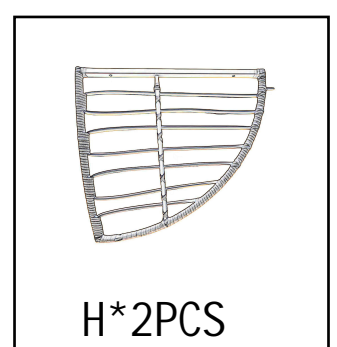

H\*2PCS

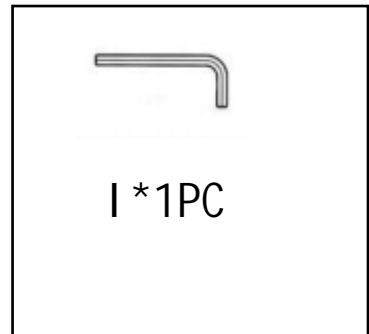

I\*1PC

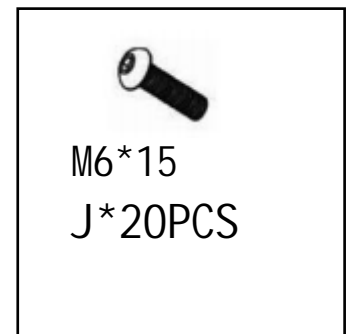

M6\*15

J\*20PCS

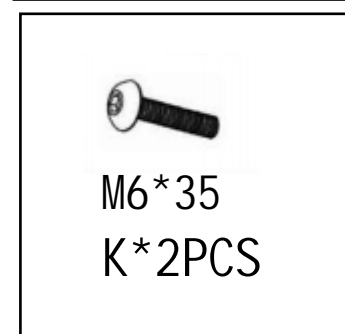

M6\*35

K\*2PCS

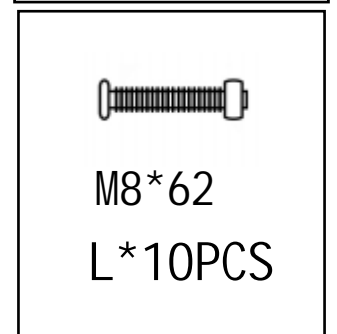

M8\*62

L\*10PCS

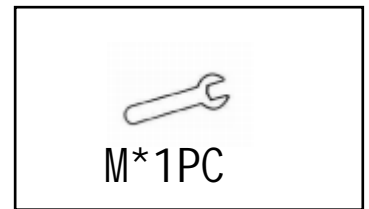

M\*1PC

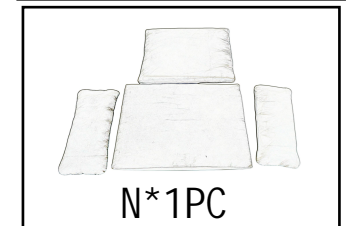

N\*1PC

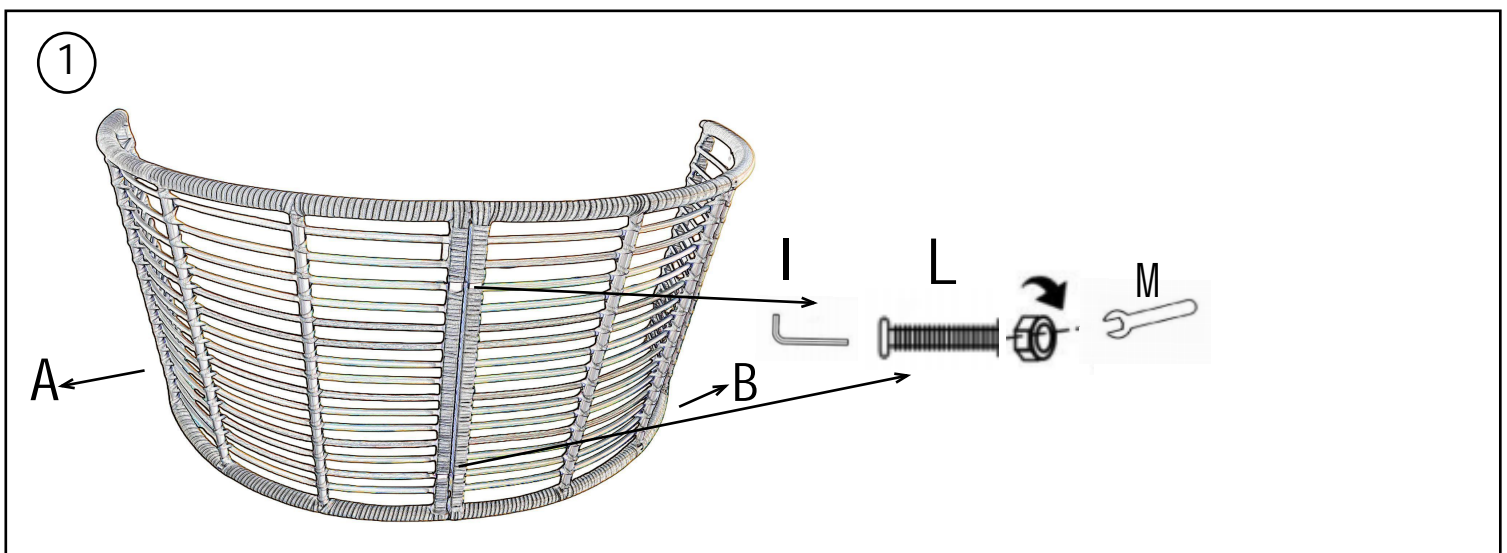

2

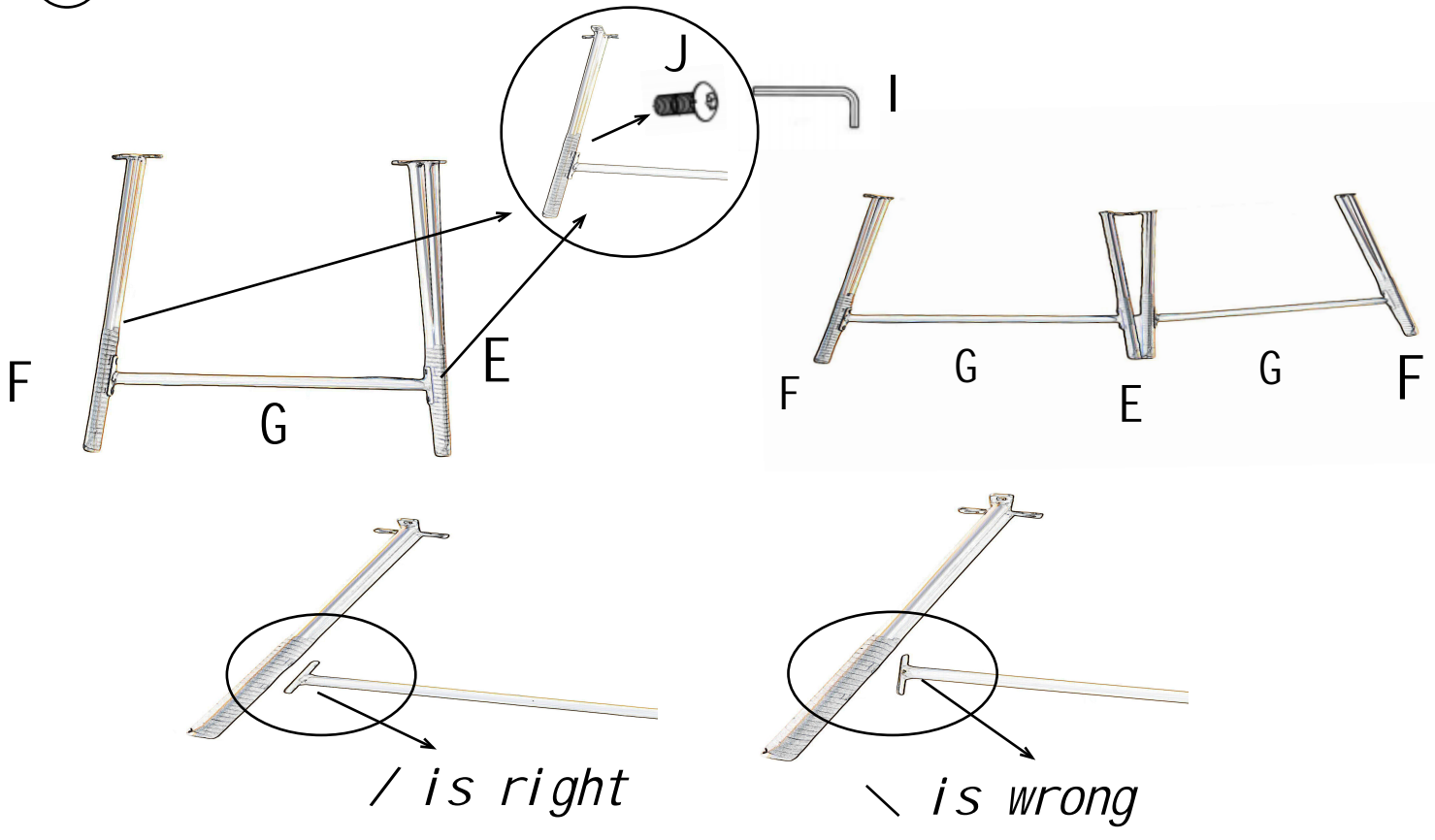

3

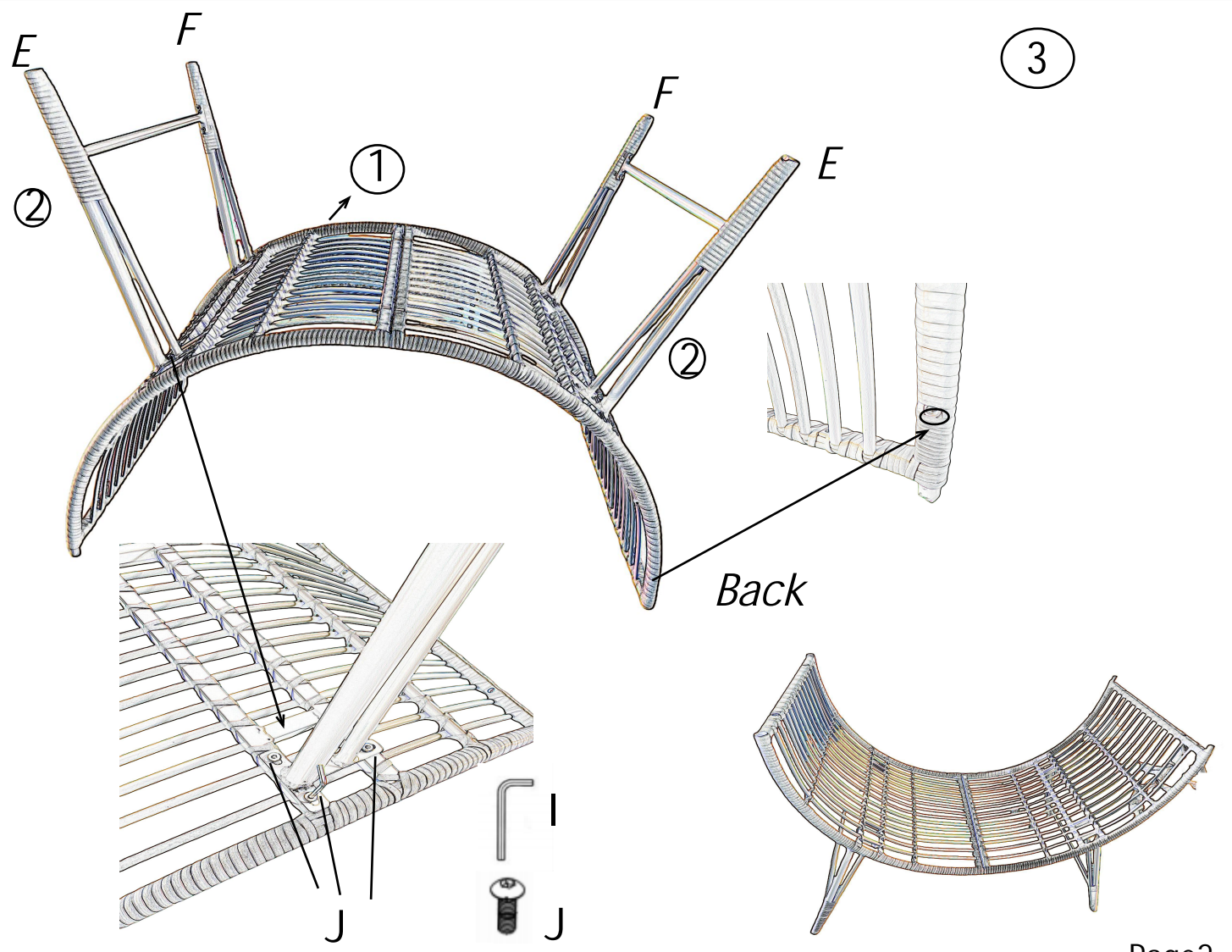

④

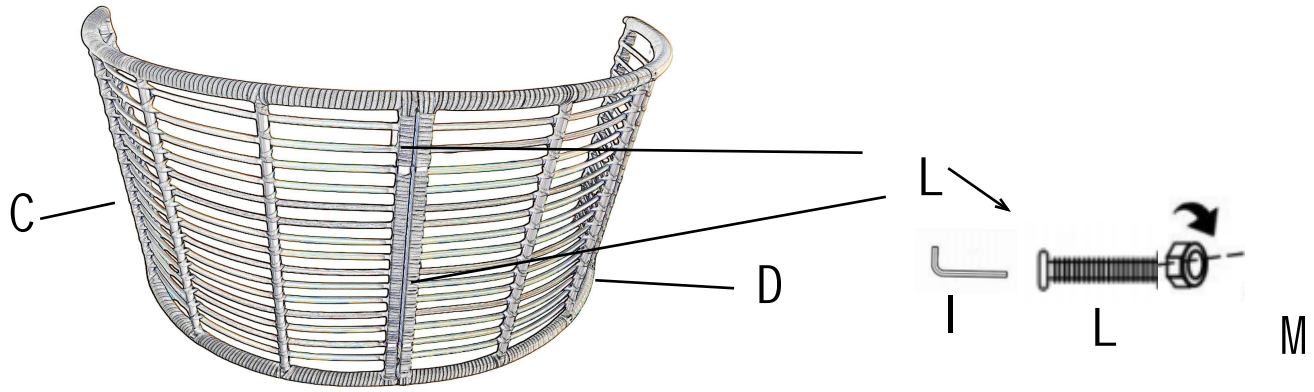

⑤

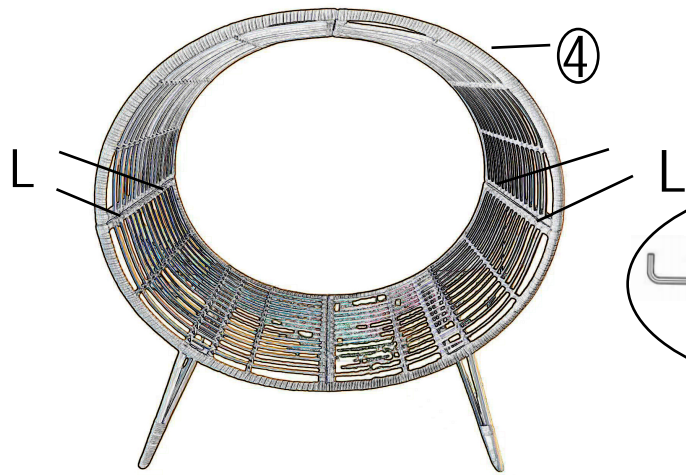

⑥

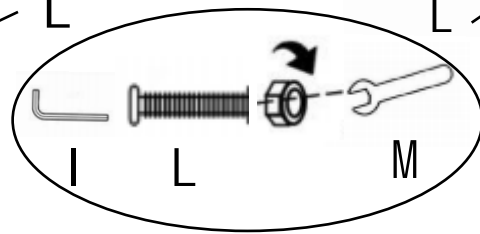
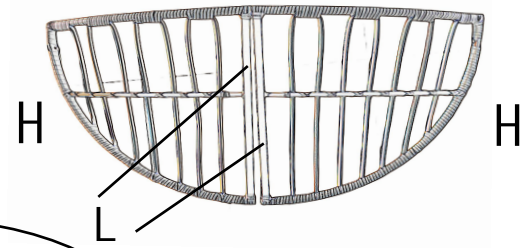

⑦

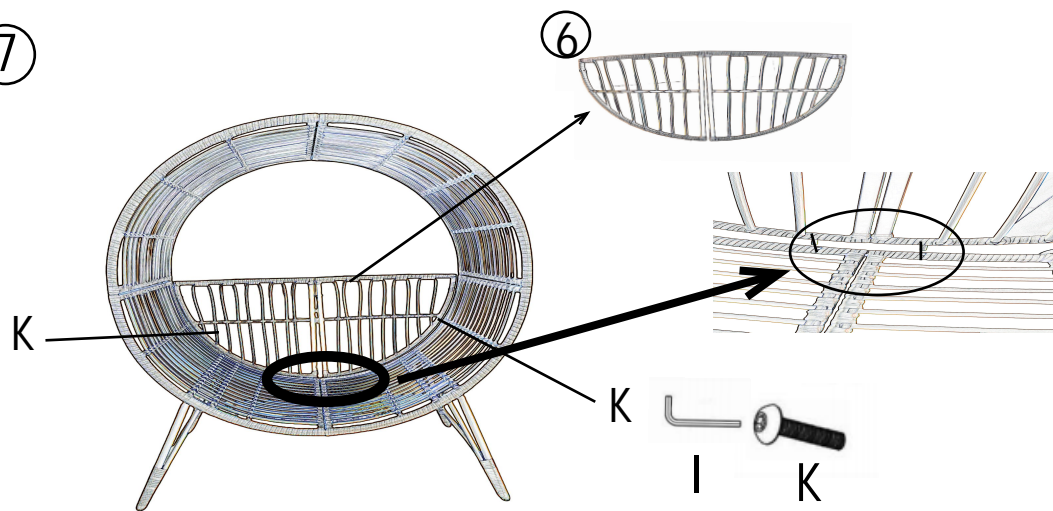

⑧

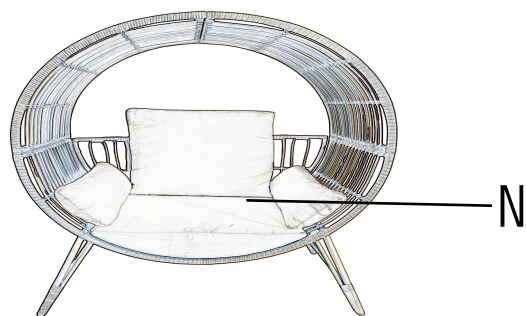

# WARRANTY INFORMATION

- Clean the surfaces preferable with a clean damp cloth, then dry with a clean towel.
- Do not use solvents or abrasive materials to clean the unit. If you decide to use a cleaning agent, test first on an area hidden from view.
- Replacement parts might be available to you at no charge, with an original proof of purchase and where a defect has arisen, wholly or substantially, as a result of faulty manufacturing, parts or workmanship during the Warranty Period.
- The warranty does not extend to regular wear and tear, nor the manufacturer assumes liability for damages or consequences due to accidents, incorrect assembly, negligence, improper use, modifications, or not heeding the above warnings.
- Thank you so much for your support! We hope you enjoy your purchase. If there is any damage or missing accessories, please feel free to contact us for free replacement or refund. You can quickly find us through this  
Service Email: **Service7770@outlook.Com**  
Service Line: **+1-888-292-2399**  
with your order number we will try our best to solve this problem for you!

Thank you !