

QUEEN/FULL
ASSEMBLY
INSTRUCTION

IMPORTANT – READ CAREFULLY – RETAIN FOR FUTURE REFERENCE

WARNING Children must stay away from the assembly zone, preventing children from potential asphyxia because of plastic bag and foam breathing in nose;

WARNING For your safety, please do not tread or climb product.

WARNING The loading weight of seating shall be within the range that vendor claims.

WARNING The product is designed for adults use, domestic use and indoor use only.

WARNING The product shall not combine with other product for use.

WARNING check regularly that all assembly fastenings are properly tightened, do not use the product if any structural part is broken or missing

WARNING Incorrect installation and incorrect use can cause accidents. Please completely follow the guidance of assembly instruction.

SECURITY INSTRUCTIONS

Before assembling check whether all parts listed in the parts list have been delivered. Do not start assembling if parts are missing or damaged.

A failure to assemble this product correctly could cause damage or result in serious injury!

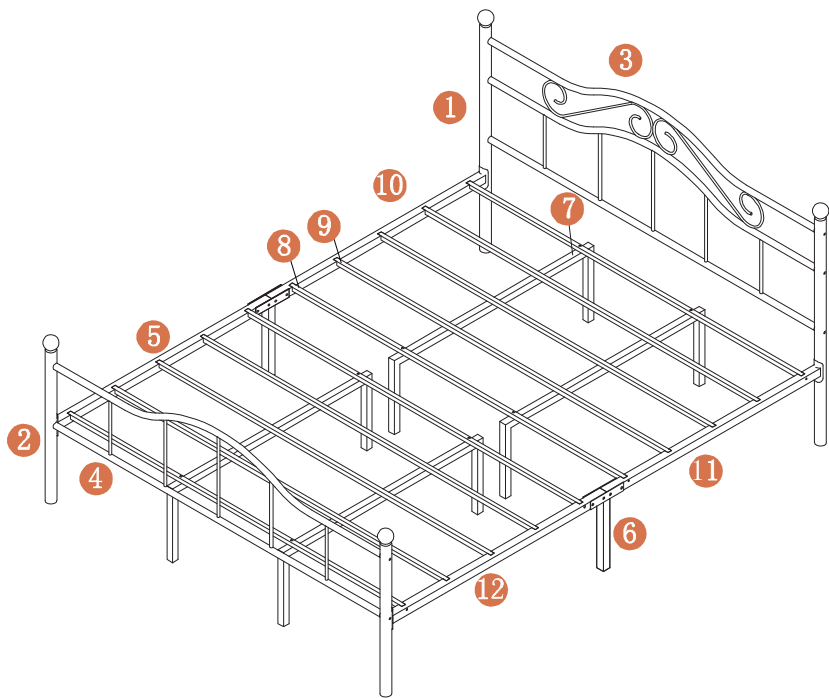

Before assembling make sure that you have enough space for the procedure. Assemble on a flat surface. Keep the assembly instructions available at all times and follow each of the individual steps exactly.

During assembly, be careful with all the parts of the assembly (do not walk on them or distort them) and beware of shearing and trapping risks. Keep children and pets away while setting up the furniture.





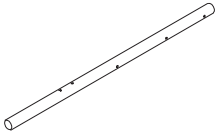
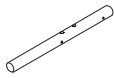
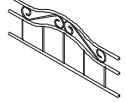
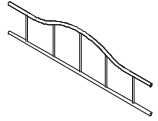
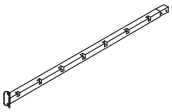

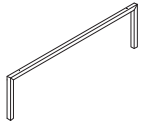
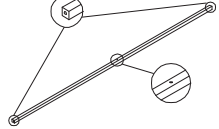
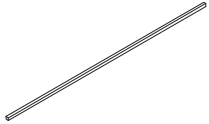
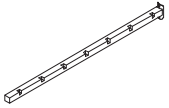
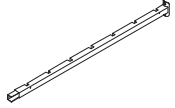
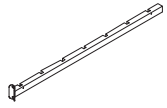







Parts List

◆ Components of furniture

1 Headboard Bar X2 	2 Footboard Bar X2 	3 Headboard Frame X1 
4 Footboard Frame X1 	5 Bedside Frame X1 	6 Bedside Supportor X2 
7 Support Frame X4 	8 Main Slat X4 	9 Slat X6 
10 Bedside Frame X1 	11 Bedside Frame X1 	12 Bedside Frame X1 

◆ Hardware accessories

A	M6x60  X10	E	M6x25  X8	I	M6*35  X8
B	M8x27  X8	F	M6x45  X8	J	 X4
C	M8x30  X8	G	φ 22  X10		4#  X1
D	M6x27  X8	H	Plastic Cap  X20		5#  X1

Assembly Steps

Step 1. Please use screw **A** to lock Headboard Frame **3** with accessory **G** on Headboard Bar **1** as below.

Tips: Please do not completely tighten up screws! Will be tighten up completely in the end.

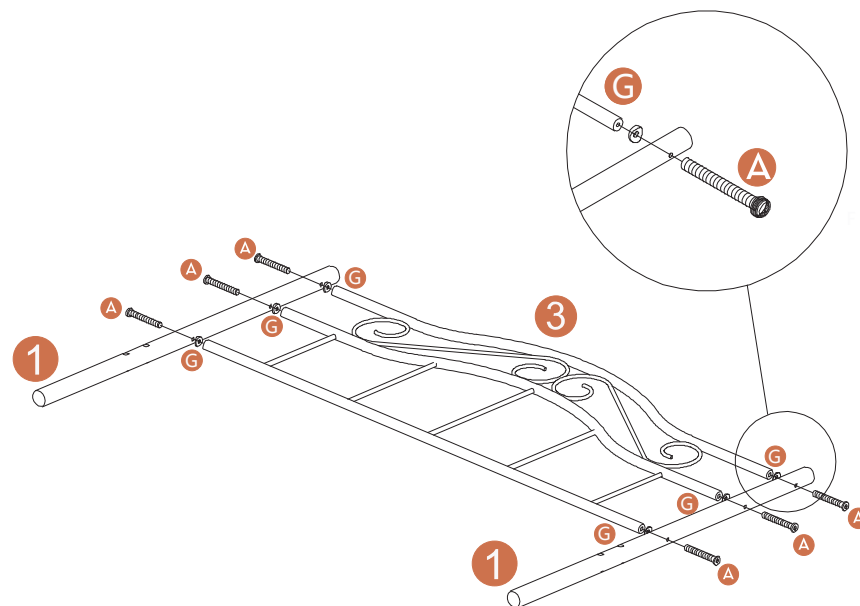
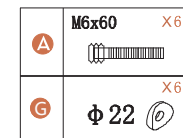
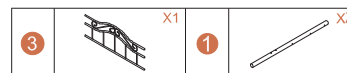

Step 2. Please use screw **A** to lock Footboard Frame **4** with accessorie **G** on Footboard Bar **2** as below.

Tips: Please do not completely tighten up screws! Will be tighten up completely in the end.

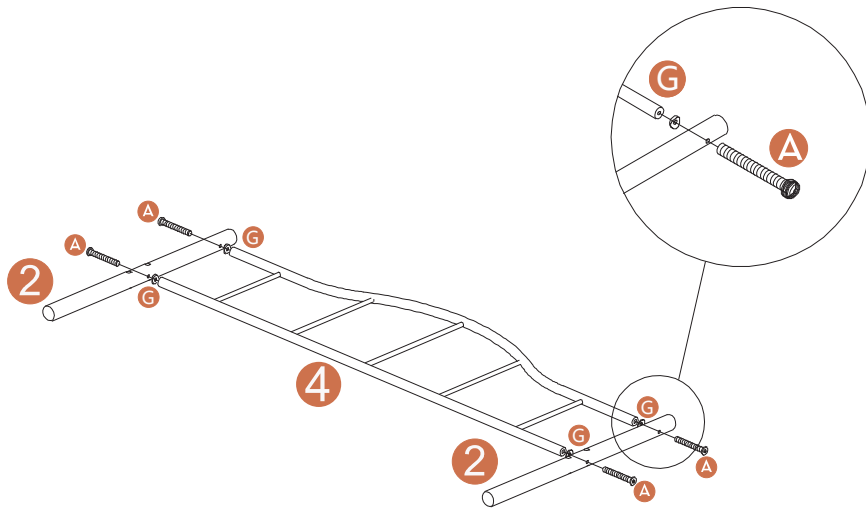
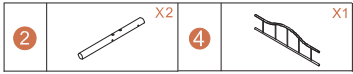

Step 3. Please use screw **B** & **C** to lock bedside frame **10** / **11** on Headboard as below.

Tips1: Please make sure the bedside frame's notches are all aligned inward as picture in below.

Tips2: Please do not completely tighten up screws! Will be tighten up completely in the end.

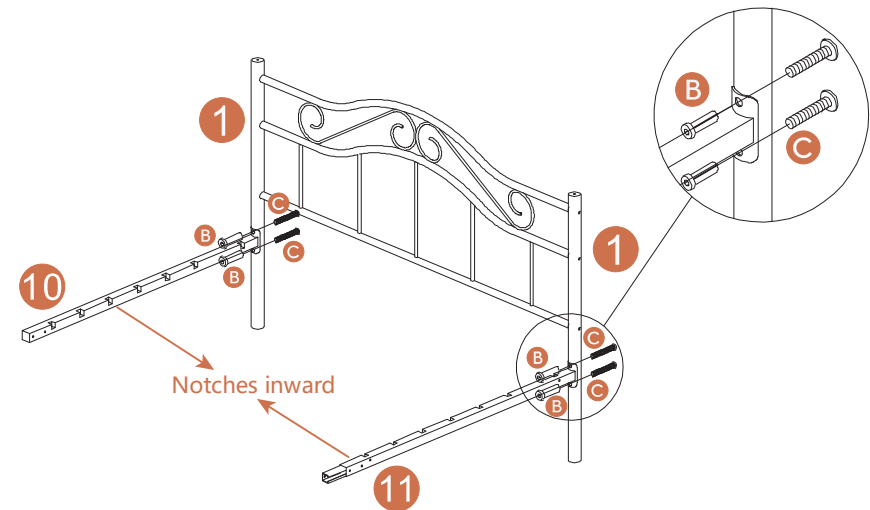
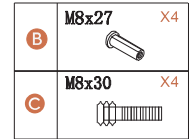
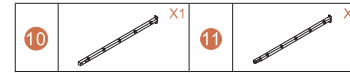

Step 4. Please use screw **B** & **C** to lock bedside frame **5** / **12** on Footboard as below.

Tips1: Please make sure the bedside frame's notches are all aligned inward as picture in below.

Tips2: Please do not completely tighten up screws!
Will be tighten up completely in the end.

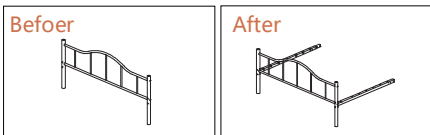
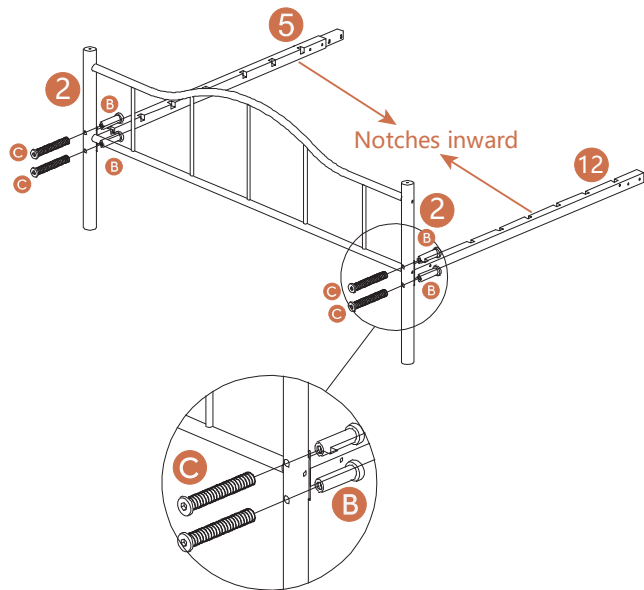
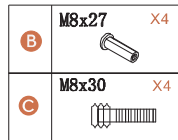
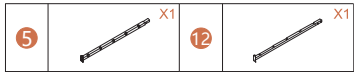

Step 5. (1) Please plug in bedside frame **5** & **10** / **11** & **12** as below
(2) Supportor **6** attached with bedside frames and make sure each side holes are matched completely;

(3) use screw **D** & **E** lock bedside frame as below

Tips: Please do not completely tighten up screws ! Will be tighten up completely in the end.

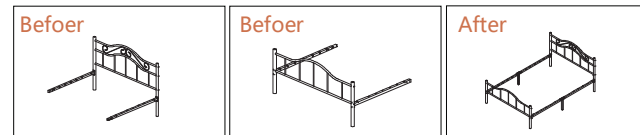
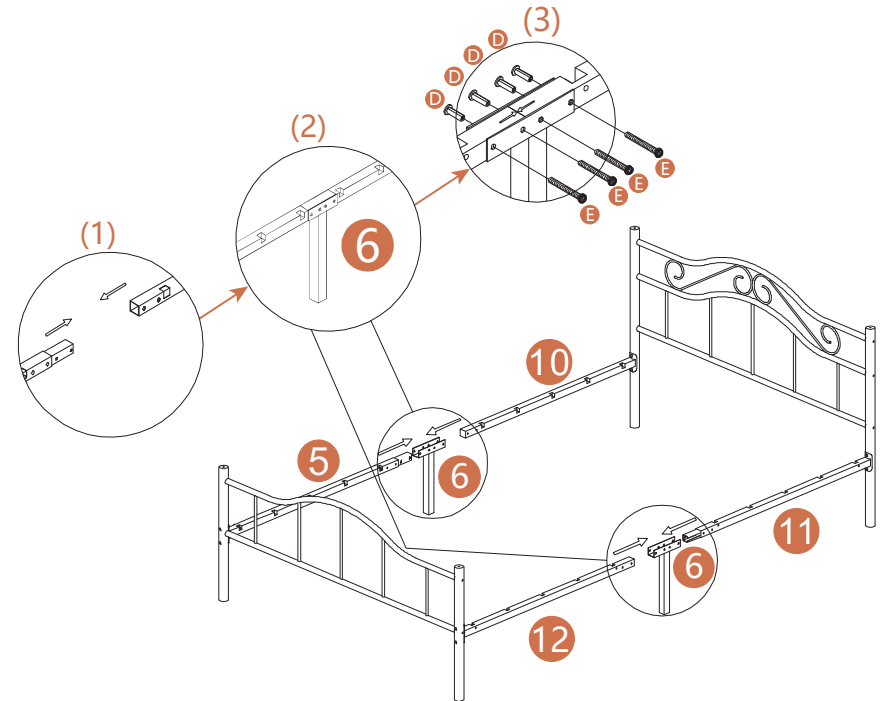
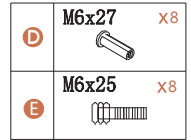
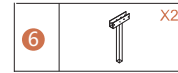

Step 6. (1) Please wearing cup **H** on main slat **8** with two sides; and make sure holes in the middle all upward as below;
 (2) Plug in main slat **8** on bedside frame as below; Please make sure plug in are completely.

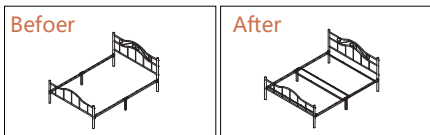
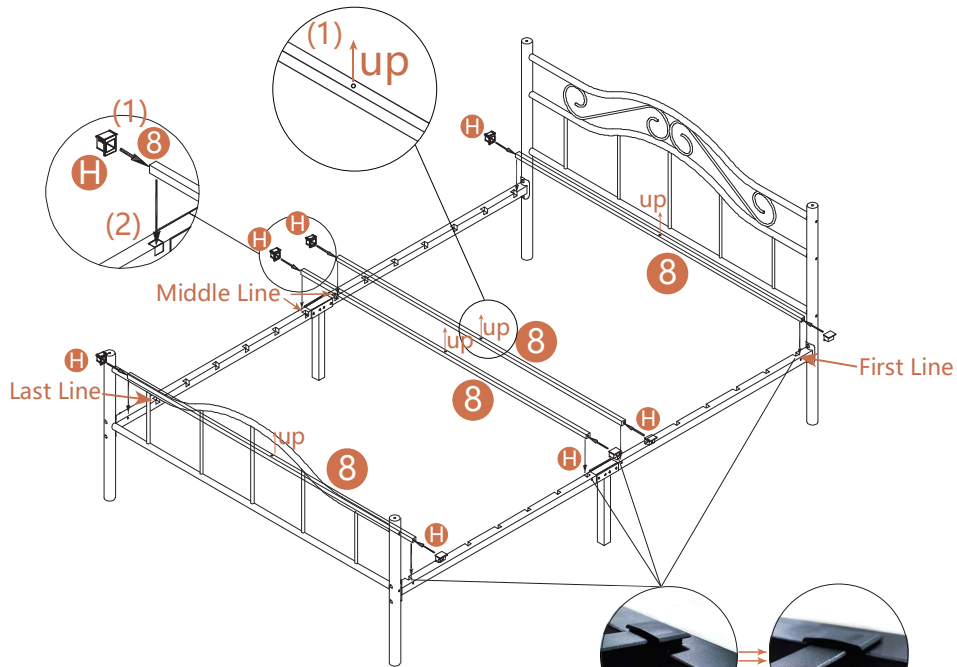
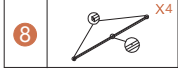

Step 7. Please use screw **F** to lock support frame **7** completely as below.

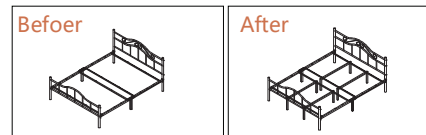
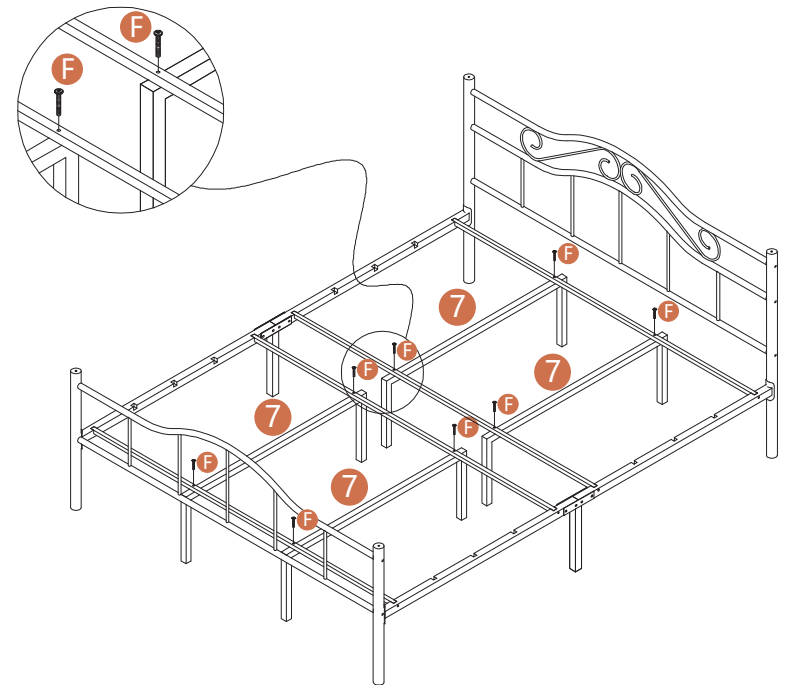
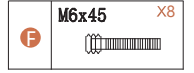
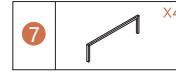

Step 8. (1) Please wearing cup **H** on slat **9** with two sides;
 (2) Plug in main slat **9** on bedside frame as below; Please make sure plug in are completely.

Tips: please make sure all slats are completely plugged in.

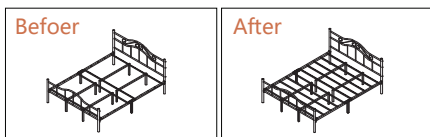
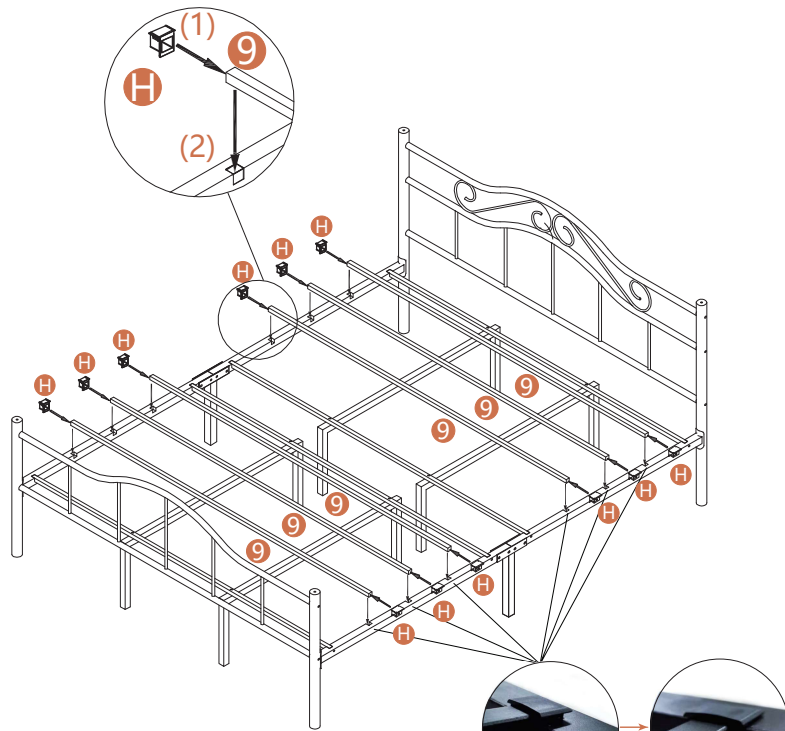

Step 9. (1) Please use screw **I** to lock main slats on bedside frame as below completely.
 (2) Please use part **J** to lock on headboard & footboard as below.
 (3) Please completely tight up all screws on the bed.

