

# ASSEMBLY INSTRUCTION

# -SOFA

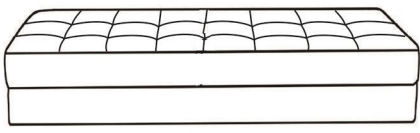

A\*1

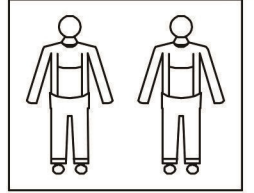
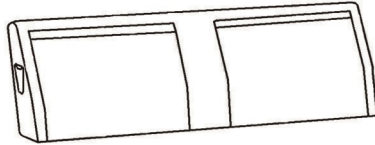

B\*1

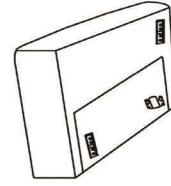

C\*1-LEFT

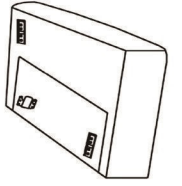

C\*1-RIGHT

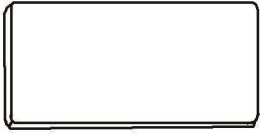

D\*2

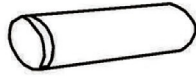

E\*2

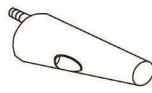

F\*2

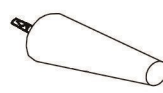

G\*2



H\*2



I\*1



J\*2



K\*4

## STEP 1

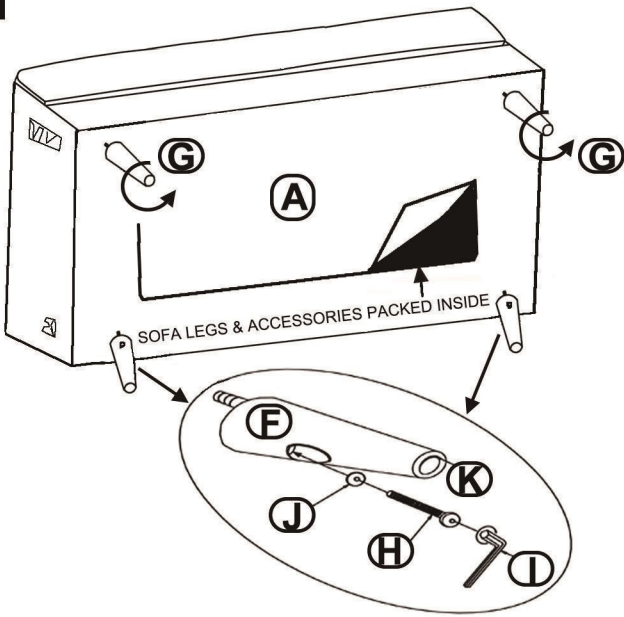

## STEP 2

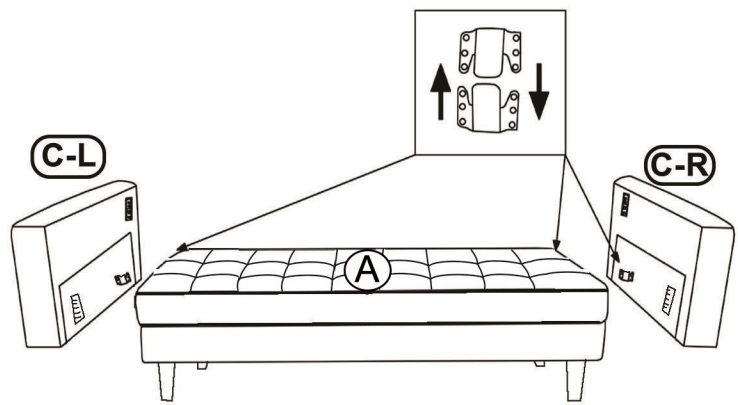

## STEP 3

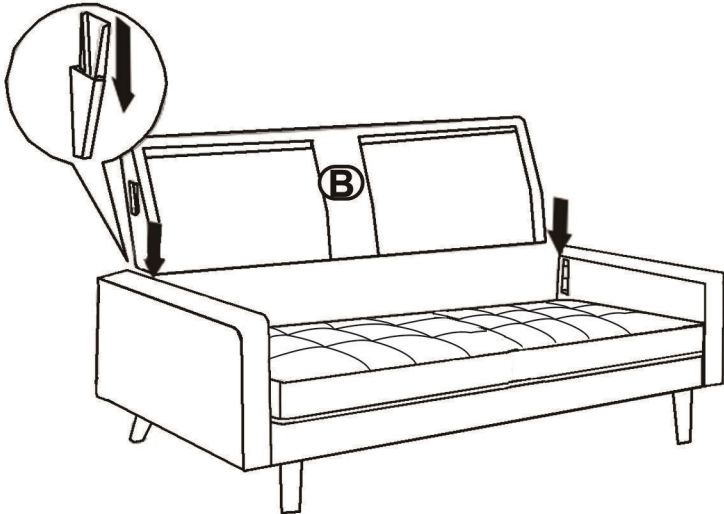

## STEP 4

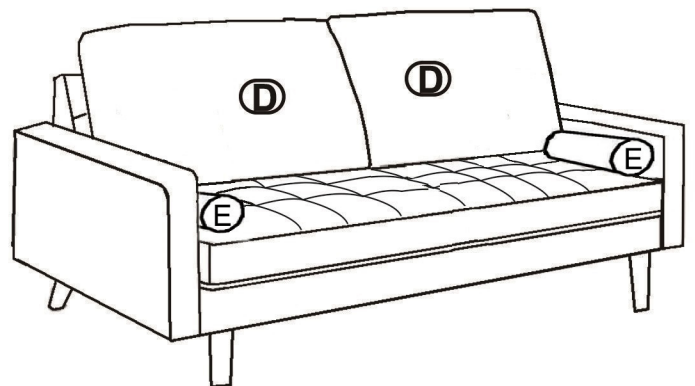

## KINDLY REMINDER

D\*2, E\*2, F\*2, G\*2, H\*2, I\*1, J\*2, K\*4  
PACKED IN SOFA STORAGE

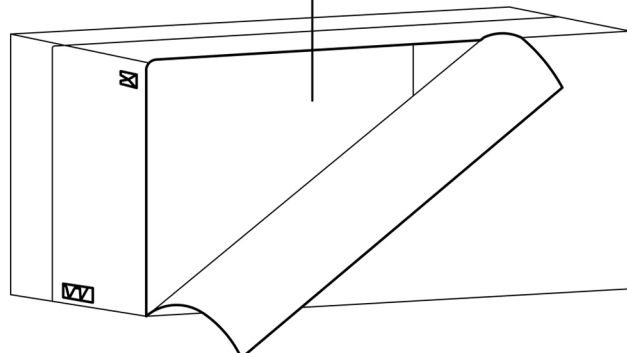

CAREFULLY UNPACK AND PLACE THE SOFA BODY (A) ON A CLEAN FLAT SURFACE TO SHOW THE BASE AS SHOWN.  
UNPACK PARTS FROM THE STORAGE COMPARTMENT