

WARNING!



Be sure electrical power is OFF before and during installation or maintenance.
The luminaire must be installed by a qualified electrician, in accordance with all applicable local codes.

Ensure that the rated luminaire voltage requirements are compatible with the available mains supply in which it will be installed.
All LEDs are included in your lamp. Never touch the LED surface with your bare hands as this may reduce the life of your LED.
Do not alter, relocate or remove any electrical component.

Line: Frame
Family: Pendant
Description: Frame Accord Cylindrical 1430

Material: Natural Wood Veneer MDF and Acrylic
Weight:

INSTALLING THE FIXTURE ON CEILING

Turn OFF the power before start the installation.

- ① Pass the support steel cables through the holes on adjustable make sure that the end pass through the hole in the side. Then, screw these assemblies into each anchor fixed on ceiling.

Reserve excess cable by wrapping it or cut it using suitable pliers.

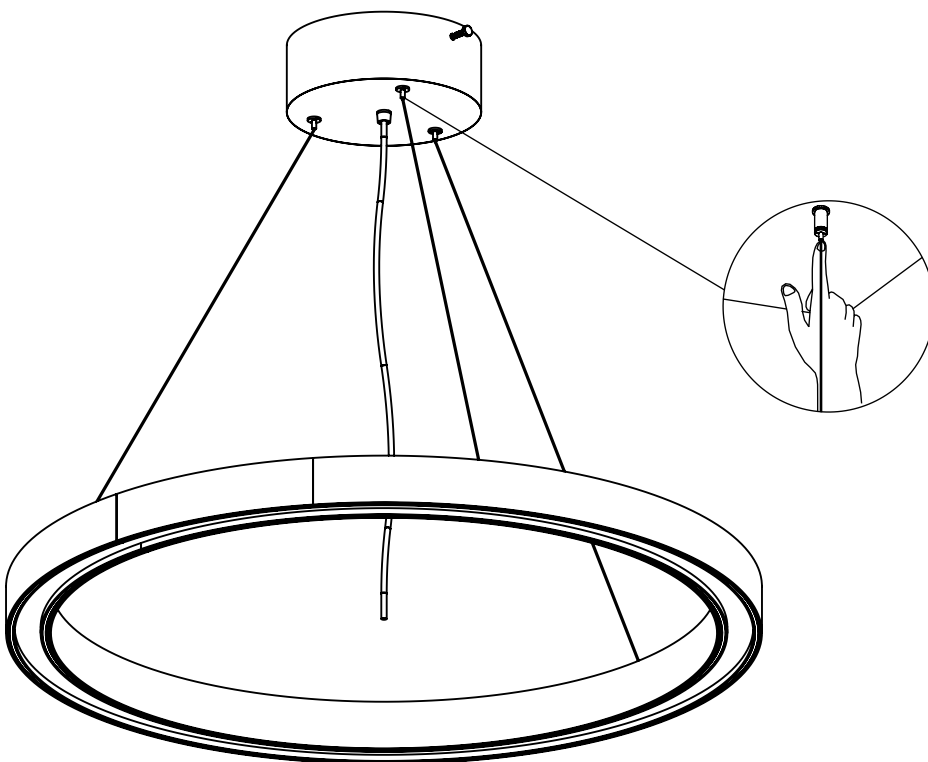

ATTENTION!



FAILURE TO COMPLY WITH THESE INSTRUCTIONS MAY CAUSE ACCIDENTS AND LOSS OF PRODUCT WARRANTY.
It's recommended to read these instructions completely and carefully before proceeding.

SAVE THESE INSTRUCTIONS FOR FUTURE REFERENCE.

ACCORD Lighting guarantees coverage against manufacturing defects including electrical components and finishes, for a period of three years, under normal use, from the date of purchase. For warranty service, please contact your local dealer for further instructions. Proof of date of purchase will be required for validation of warranty service.

The responsibility of the manufacturer regarding the product warranty is related to the correct observation of the instructions contained in this manual. The manufacturer is not responsible for any damage to the product caused by accidents, alterations of any kind, improper usage or improper installation. See the website for additional warranty details.

ACCORD Lighting reserves the right to change the dimensions and specifications contained in this manual without prior notice, in accordance with its policy of continuous product improvement. Please, contact the manufacturer if additional information is necessary. The illustrations in this manual are for guidance only and may vary in scale, dimensions and model details.

WARNING!



Be sure electrical power is OFF before and during installation or maintenance. The luminaire must be installed by a qualified electrician, in accordance with all applicable local codes.

Ensure that the rated luminaire voltage requirements are compatible with the available mains supply in which it will be installed. All LEDs are included in your lamp. Never touch the LED surface with your bare hands as this may reduce the life of your LED. Do not alter, relocate or remove any electrical component.

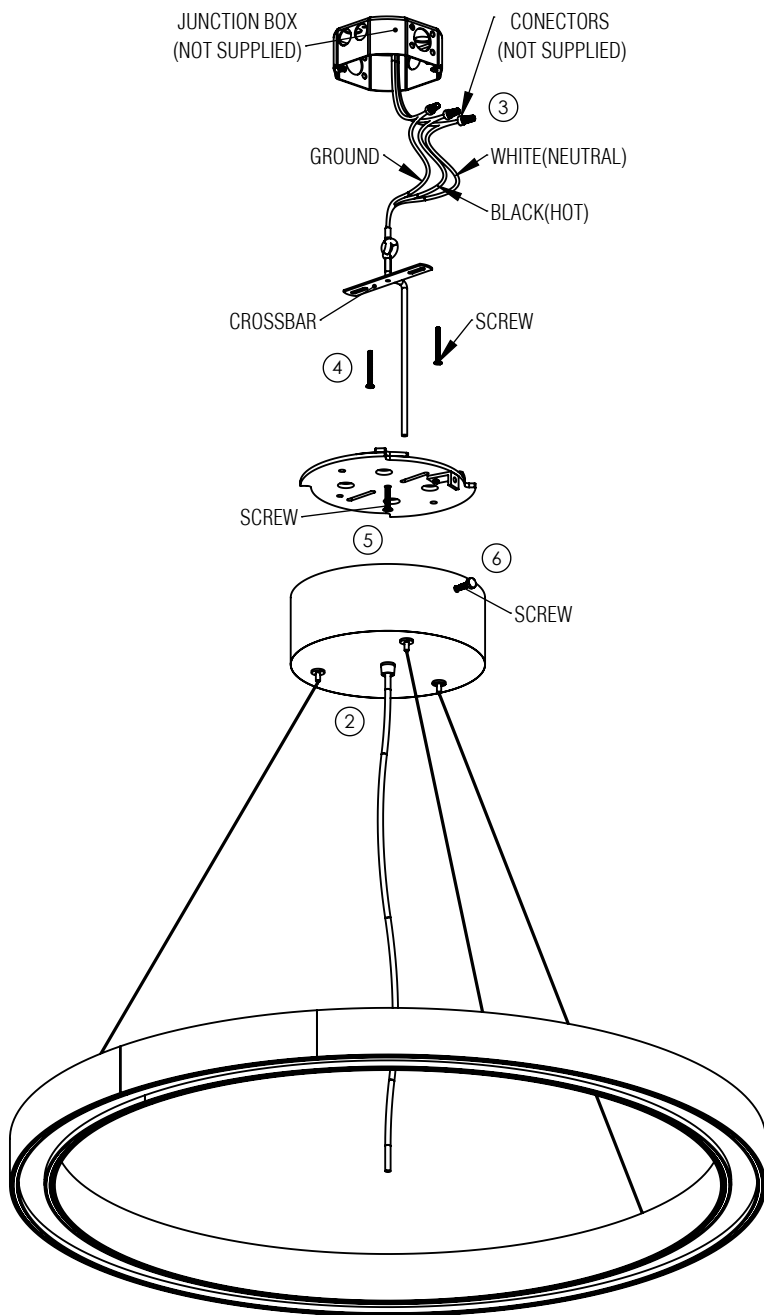

Color Temperature: 2700K, 3000K, 3500K or 4000K
CRI: 90
Luminous Flux: 1800lm
Total Power: 9W

Input Voltage: 110V or 277V
Input Frequency: 60 Hz
Isolation: Class II

Material: Natural Wood Veneer MDF and Acrylic
Weight:

Height Adjustment Limit: 160cm/63in

MAKING ELECTRICAL CONNECTIONS

- ② Pass the power supply cable through the strain relief cone, threaded tube nipple, canopies and crossbar.
- ③ Connect the electrical supply wires to the junction box in accordance to all applicable local codes, as shown in the diagram.

MOUNTING ON THE FIXTURE

- ④ Attach the crossbar to the junction box using the supplied screws.
- ⑤ Bring the canopy base to the ceiling and secure it by screwing.
- ⑥ Bring the canopy to the ceiling and secure it by screwing the side of the canopy at its base.

Turn ON electrical power.

Your luminaire is now ready for use.

DIMMER COMPATIBILITY

The LED driver included with this fixture is designed to operate with most standard dimmers. All power ratings and installation instructions from dimmer manufacturers' instruction sheets must be followed.

ATTENTION!



FAILURE TO COMPLY WITH THESE INSTRUCTIONS MAY CAUSE ACCIDENTS AND LOSS OF PRODUCT WARRANTY. Its recommended to read these instructions completely and carefully before proceeding.

SAVE THESE INSTRUCTIONS FOR FUTURE REFERENCE.

ACCORD Lighting guarantees coverage against manufacturing defects including electrical components and finishes, for a period of three years, under normal use, from the date of purchase. For warranty service, please contact your local dealer for further instructions. Proof of date of purchase will be required for validation of warranty service.

The responsibility of the manufacturer regarding the product warranty is related to the correct observation of the instructions contained in this manual. The manufacturer is not responsible for any damage to the product caused by accidents, alterations of any kind, improper usage or improper installation. See the website for additional warranty details.

ACCORD Lighting reserves the right to change the dimensions and specifications contained in this manual without prior notice, in accordance with its policy of continuous product improvement. Please, contact the manufacturer if additional information is necessary. The illustrations in this manual are for guidance only and may vary in scale, dimensions and model details.