

ASSEMBLY INSTRUCTIONS

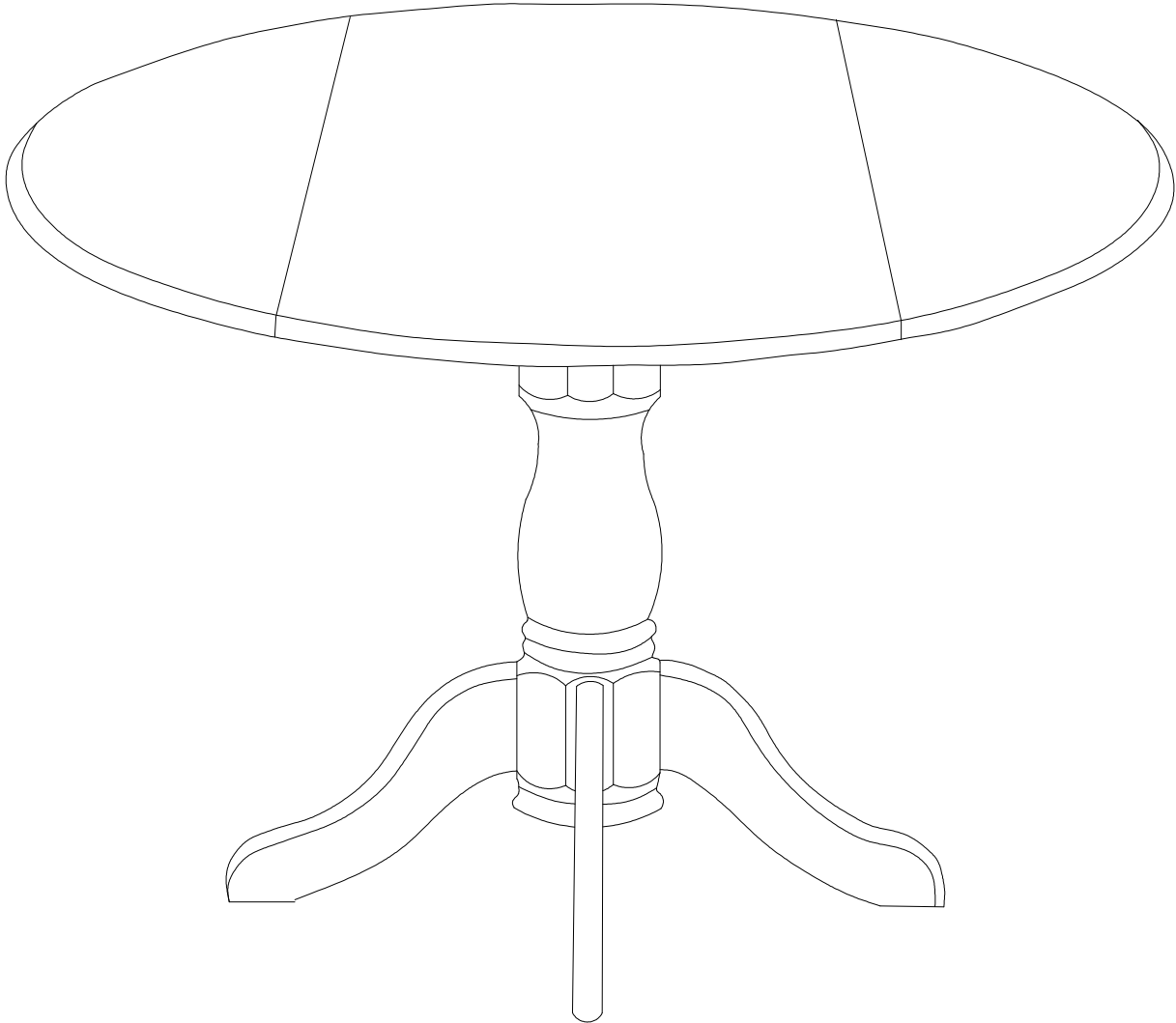

Description : ROUND TABLE WITH 2 DROP LEAVES :

Dimension ϕ 42" x 29" 1/2.H

Cube Size : 44" x 26.7" x 3.1"

NW: 28.6 LBS

(TOP)

GW: 31 LBS

Cube Size : 25.5" x 9" x 6"

NW: 12.1 LBS

(PEDESTAL)

GW: 14 LBS

ROUND TABLE WITH 2 DROP LEAVES

BEFORE ASSEMBLY

Thank you for purchasing this quality product. This product has been designed for easy assembly and constructed for durability. Please take the time to read and follow the assembly instructions carefully.

Be sure to check all packing material carefully for small parts which may have come loose inside the carton during shipment. Please separate, identify, and count all parts and metal hardware. Compare with part list to be sure all parts are present.



If hardware is missing or you have difficulty assembling this product, please call for us.

IMPORTANT NOTE:

- Place all wooden parts on a clean and smooth surface such as a rug or carpet to avoid the parts from being scratched.
- Remove all wrapping material, including staples & packing straps before you start to assemble.
- DO NOT tighten all screws and bolts until completely assembled.
- Keep all hardware parts out of reach of children.



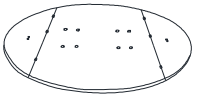

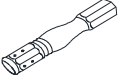
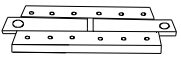



PART LIST

When unpacking, please be careful not to discard any parts with the packaging. Before continuing, please make sure you have the following parts:

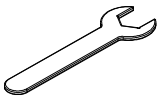
NO	Description	Qty	Sketch	NO	Description	Qty	Sketch
A	Top	1		B	Leg	4	
C	Pedestal	1		D	Mounting plate	1	

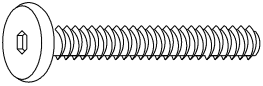
HARDWARE LIST

When unpacking, please be careful not to discard any parts with the packaging. Before continuing, please make sure you have all of the following hardware:

NO	Description	Qty	Sketch	NO	Description	Qty	Sketch
1	Large flat washer ($\Phi 8.5 \times \Phi 19 \text{mm}$)	4		2	Large lock washer ($\Phi 8.5 \times \Phi 11 \text{mm}$)	4	
3	Hexagon nut (M8x13mm)	4		4	Wrench (M13mm)	1	
5	Small flat washer ($\Phi 6.5 \times \Phi 13 \text{mm}$)	4		6	Small lock washer ($\Phi 6.5 \times \Phi 9 \text{mm}$)	12	
7	Bolt (M6x48mm)	12		8	Medium flat washer ($\Phi 6.5 \times \Phi 16 \text{mm}$)	8	
9	Allen key (M4)	1		10	Screw M3.5x20	4	
11	Plastic	2					

ROUND TABLE WITH 2 DROP LEAVES

STEP 1

Attach legs (B) to the pedestal (C) with washers (1), (2) and nuts (3). Tighten with wrench (4).

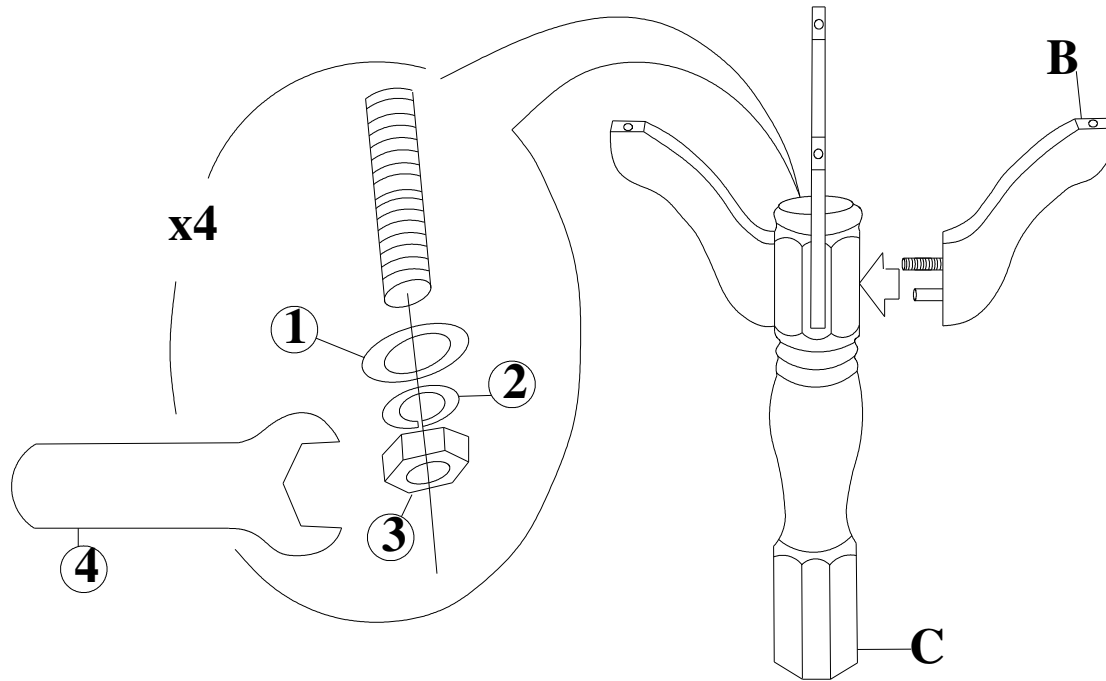

STEP 2

Put the Mounting plate (D) on top of the pedestal, and attach with bolts (7), washers (5), (6). Tighten with Allen key (9).

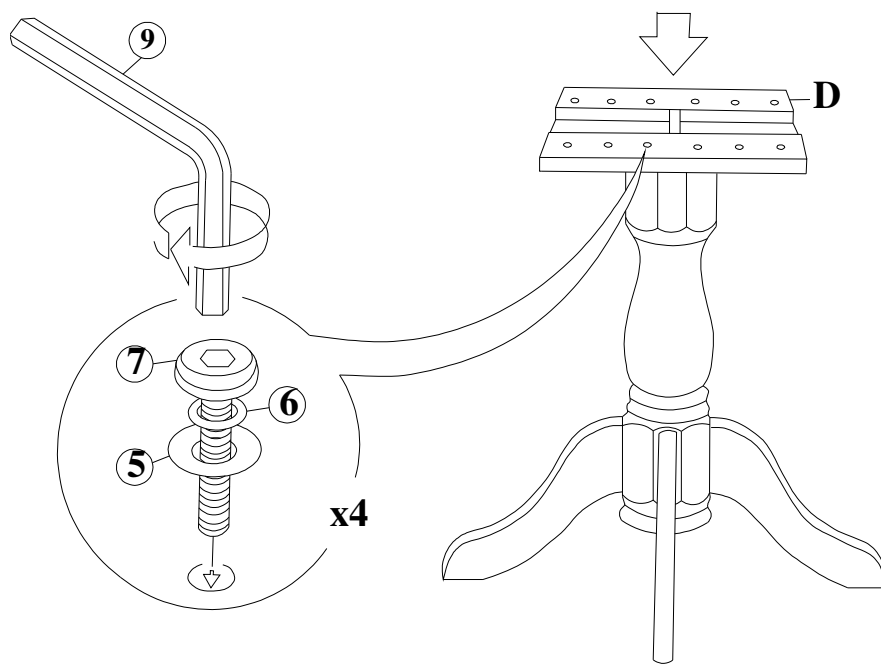

ROUND TABLE WITH 2 DROP LEAVES

STEP 3

Attach plastic(11) to the top (A). use the screw driver to tighten the screws (10) as shown below.

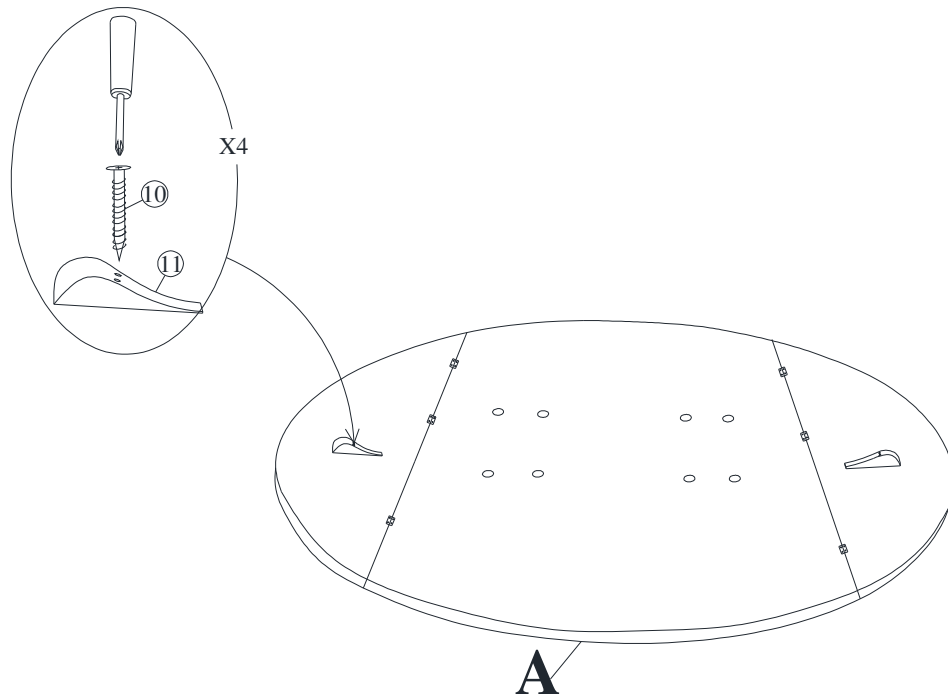

STEP 4

Carefully place the frame (from Step 2) on bottom side of the table top (A), with bolts (7), washers (8), (6). Tighten with Allen key (9).

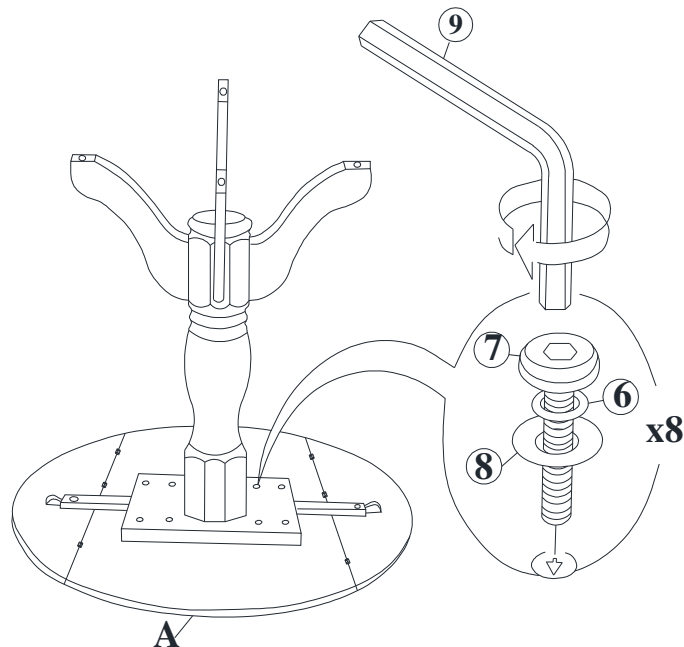

ROUND TABLE WITH 2 DROP LEAVES