

# ASSEMBLY INSTRUCTIONS

## Upholstered Chair

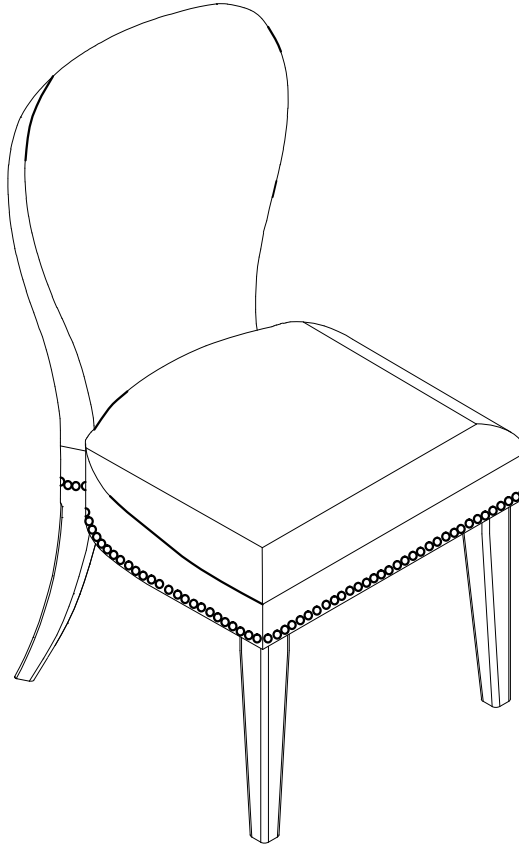

### REPLACEMENT PARTS

Please do not contact the company purchased from as we can help you faster.

Order replacement parts and hardware at "[boltonfurniture.com](http://boltonfurniture.com)"

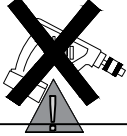
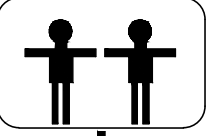
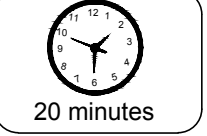
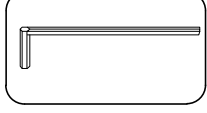
 <p>. Use of power tool to assemble this product will invalidate any claim and damage this product making it unsafe!!! . Please assemble on a clean soft surface to avoid damage.</p>	 <p>+</p>  <p>20 minutes</p>	<p><u>Tool Included</u></p> 
--	--	---

# Upholstered Chair

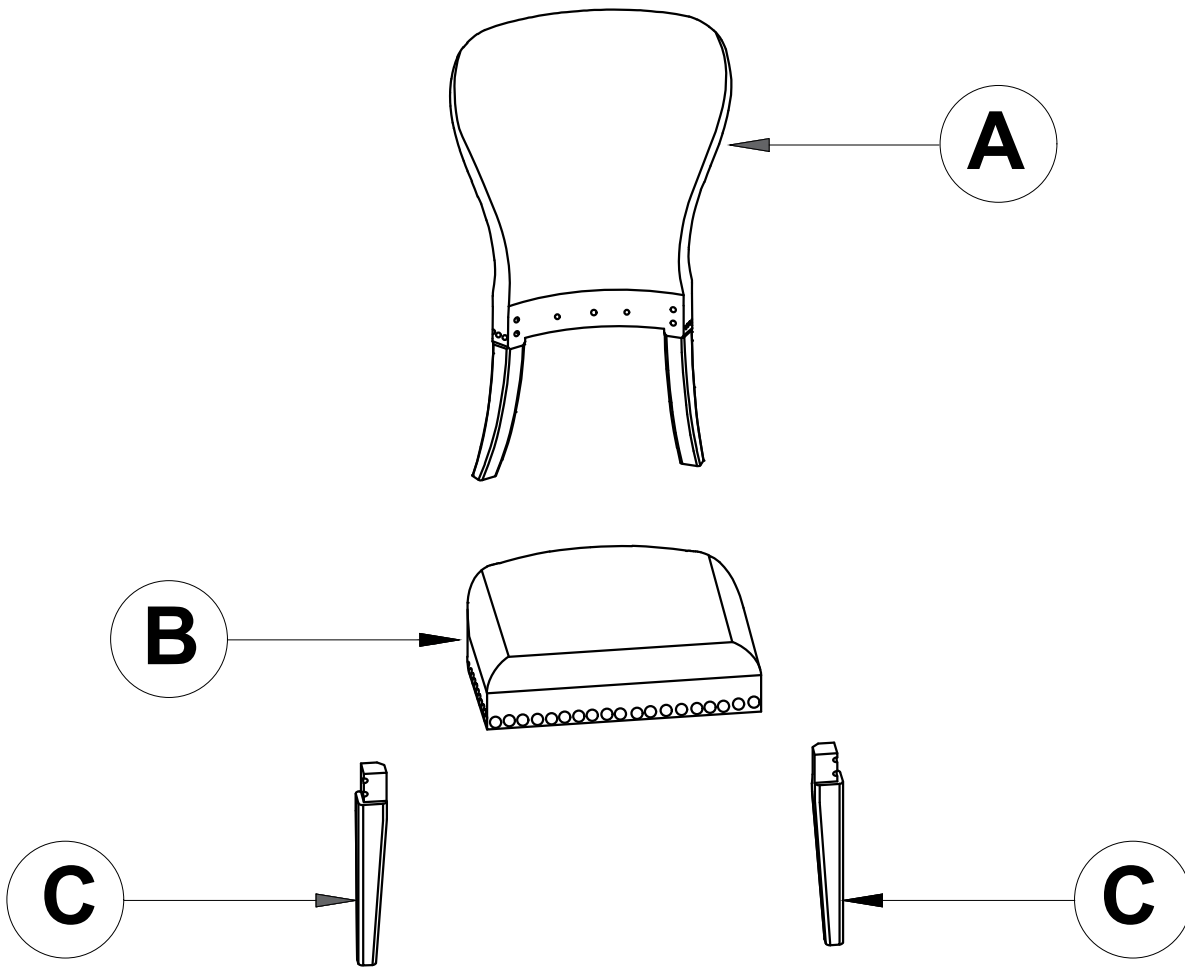

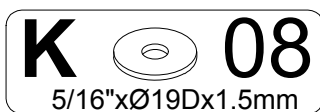
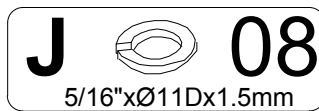
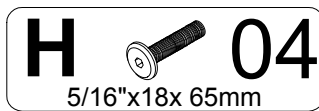
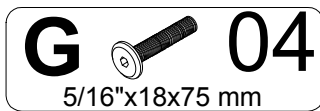
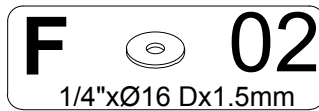
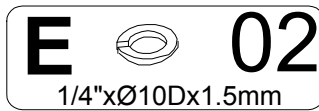

Identifying the hardware-Identify the hardware using the illustrations below.



# Step 1

**D**  **02**  
1/4"x20x50 mm

**E**  **02**  
1/4"xØ10Dx1.5mm

**F**  **02**  
1/4"xØ16 Dx1.5mm

**L**  **01**  
ALLEN WRENCH

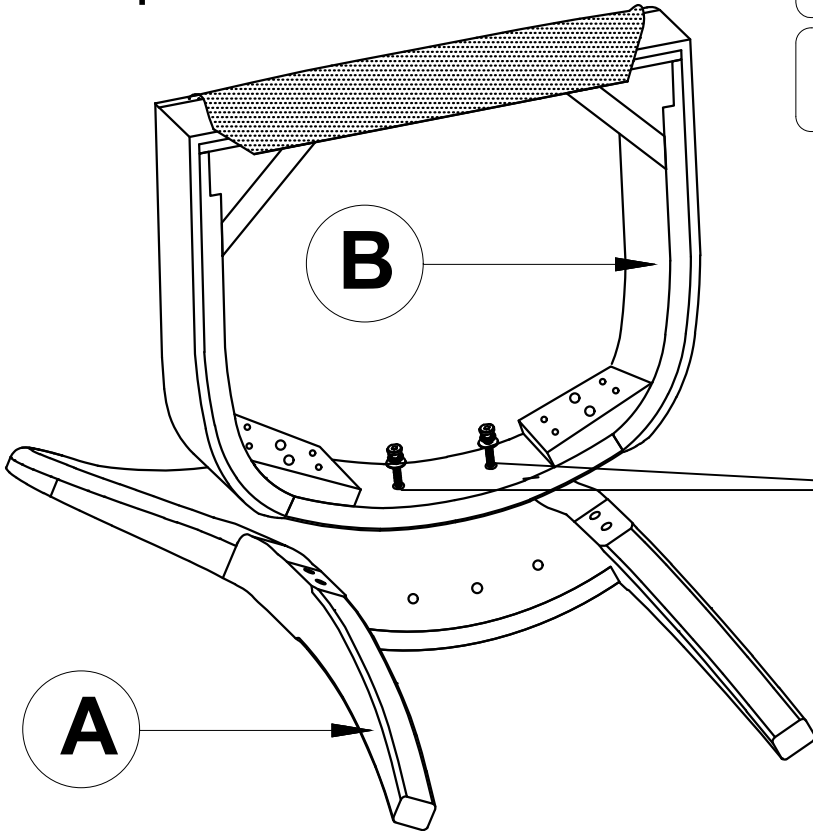

# Step 2

**G**  **04**  
5/16"x18x75 mm

**J**  **04**  
5/16"xØ11Dx1.5mm

**K**  **04**  
5/16"xØ19Dx1.5mm

**L**  **01**  
ALLEN WRENCH

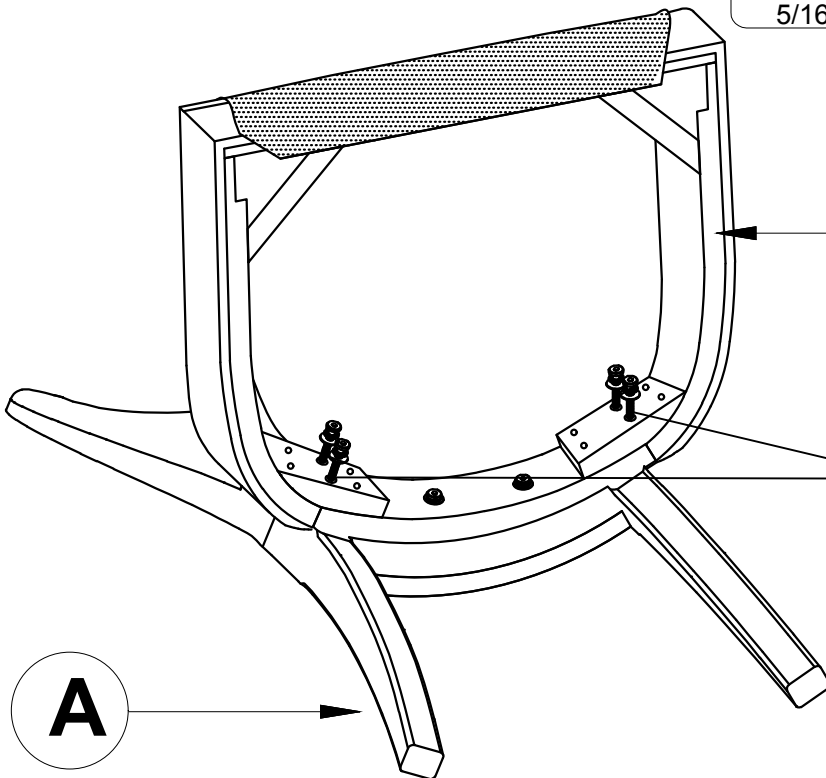

# Step 3

**H**  **04**  
5/16"x18x 65mm

**J**  **04**  
5/16"xØ11Dx1.5mm

**K**  **04**  
5/16"xØ19Dx1.5mm

**L**  **01**  
ALLEN WRENCH

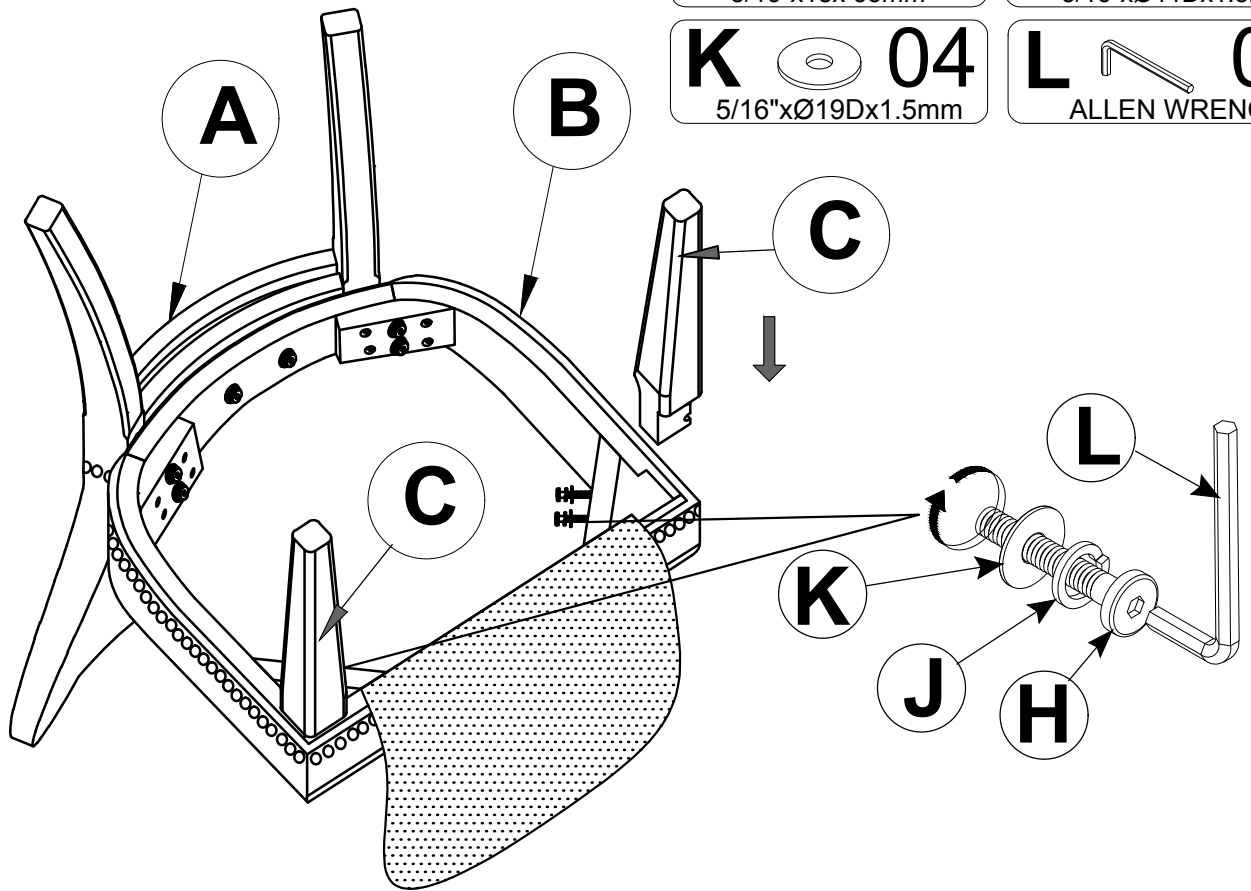

# Step 4

