



MANUAL INSTRUCTION

12X12FT POLYCARBONATE DOUBLE ROOF GAZEBO

SG401BR08-LH

SG401GR08-LH

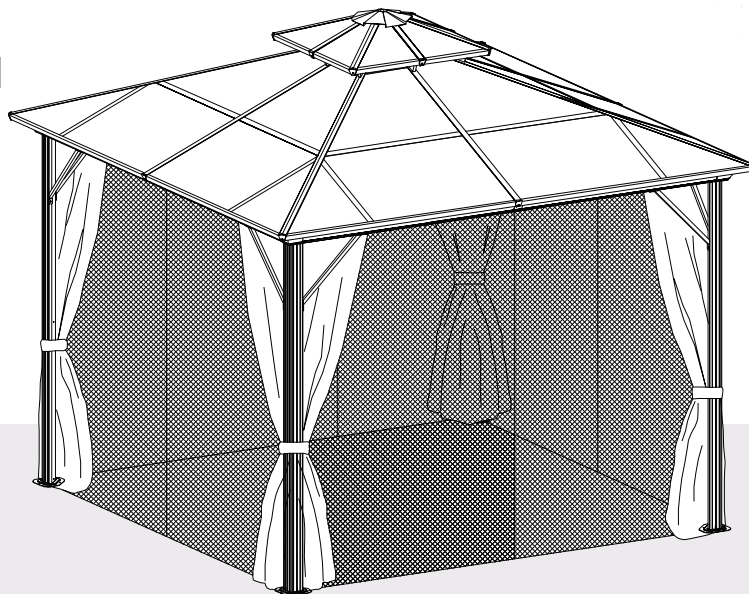

Reach us at:

 service@kmcglobe-us.com

 (+1) 559-354-1889

12X12FT POLYCARBONATE DOUBLE ROOF GAZEBO SG401GR09-LH



We offer a diverse range of products to meet the needs of customers.

part 1: Precautions and preparations 2-5

part 2: Material list (please check before installation) 6-10

part 3: Frame mounting 11-22

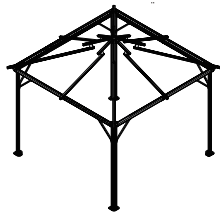

part 4: Top mounted 23-31

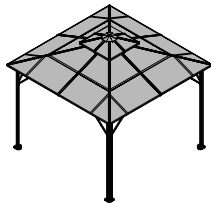

part 5: Hanging curtain installation 32-37

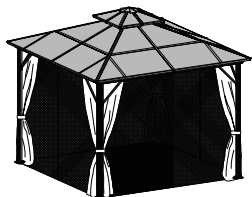

part 6: Help center 38

Outdoor Furniture

We are a professional furniture provider with top-notch factories and outstanding designs, Our mission is to provide consumers with new lifestyles. By collecting consumer feedback, we constantly improve our products and create more choices for consumers. If you want to create your space, We are an ideal choice.

Always.



WARNING

1. Two or more people are required for assembly.
2. A ladder and electric drill may be necessary.
3. Do not erect the structure in heavy winds or inclement weather.
4. Do not leave up this unit for extended periods of time, as it is not a permanent structure or designed to withstand sustained wind or rain. It is a temporary, portable shelter that shields you from sunlight and rain. The screens also block flying insects.
5. Do not use candles, matches, or any open flames near the tent.
6. To better align the screws for practical situations, do not fully tighten screws initially.
7. Professional installation is highly recommended

WARNING

- In case of windy weather, please do not stand in the gazebo.
- Please do not stand under the gazebo in case of heavy snowfall.
- For safety, please use expansion screws to reinforce the posts to the ground.
- In windy weather, please tighten the fence and netting to avoid tearing in high winds.
- In extreme weather conditions, you can use a rope to pull the four corners of the gazebo to keep it stable.
- Please clear the snow off the roof in time for the heavy snowfall.
- Make sure all screws are tightened before use.
- Repeat to confirm all screws, buckles and straps every 90 days.
- Please keep all screws loose during the assembly process and tighten them after completing the installation.
- Do not use or store next to a pole with an open flame or flammable chemicals.
- Please note that some parts have sharp edges and should be handled with gloves.
- If any parts are missing, broken, damaged or worn, discontinue use of the product until repairs are made or factory replacement parts are installed.
- Installation of the product in a manner that does not conform to the manufacturer's instructions may result in the loss of the warranty policy for this product.
- Consult your local authorities to check if permits are required to erect the shed .

WARNING

WARNING: This product can expose you to Carbon monoxide, which is known to the State of California to cause birth defects or other reproductive harm. For more information go to www.P65Warnings.ca.gov

TOOLS REQUIRED

EQUIPMENT REQUIRED (Not included in boxes)

*NOTE: Tools / equipment are not shown to actual size and scale.



LEVEL



RUBBER MALLET



PHILLIPS SCREW



DRILL



ALLEN KEY

EQUIPMENT REQUIRED (Not included in boxes)

*NOTE: Equipment are not shown to actual size and scale.



SAFETY HAT



GLOVES



SAFETY GOGGLES



STEPLADDER
(6.5ft Or More)

Matters needing attention



*Three or more people
are required for
assemblee*



*Do not fully tighten
screws prior to complete
assembly*

Part 2: Material list

(please check before installation)

Hardware list



P7

Parts list



P8-P11

HARDWARE

In case you cannot find or lose some small parts or screws during installation, we have provided extra parts '1' '4' '8' '10' 'U', it is a bag with "Additional Parts" label.

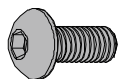

M6x16mm
1 X 124



M5x12mm
10 X 32

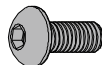

M6x25mm
3 X 1



12 X 1



ST4.8x12mm
4 X 16



13 X 1

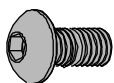

M6x10mm
5 X 8



14 X 12



M6x15mm
8 X 16

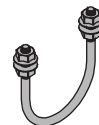

15 X 1



10x 50mm
9 X 12



M6x135mm
16 X 24

PARTS



A X 4

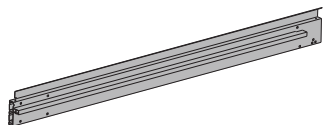

B X 4

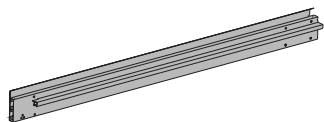

B1 X 4

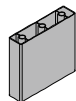

D X 4



Ea X 4



Eb X 4



E1 X 4



E2 X 4



F1 X 4



F2 X 4



F3 X 4



F4 X 4



G1 X 4



G2 X 4

PARTS



G3 X 4



G5 X 4



H X 4



H1 X 4

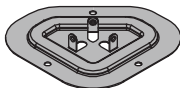

J X 4

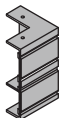

K X 4

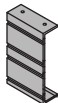

K1 X 4

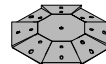

L X 1

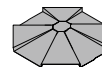

M X 1



N X 12



N1 X 8

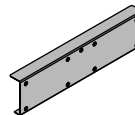

P X 4

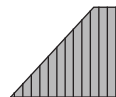

Q1 X 4

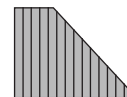

Q2 X 4

PARTS

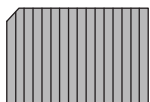

Q3 X 4

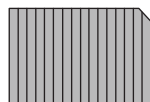

Q4 X 4



Q5 X 4



Q6 X 4



R1 X 4



R2 X 4



T1 X 1

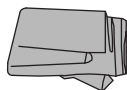

T X 1



U X 112

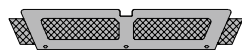

V1 X 2

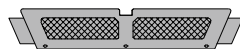

V2 X 2

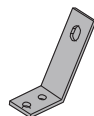

W2 X 4

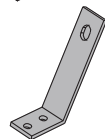

W3 X 4



17 X 4

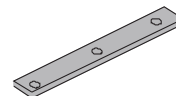

18 X 4

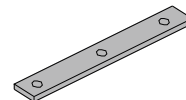

19 X 4



21 X 8



22 X 8

Part 3

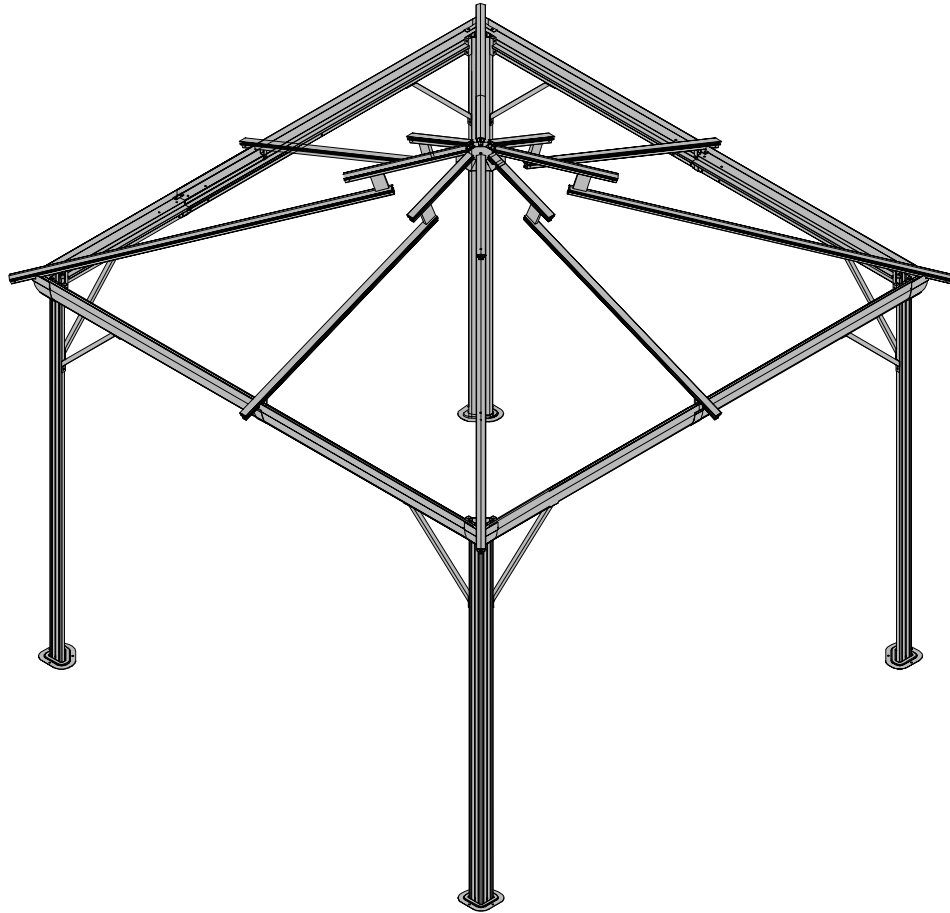

1

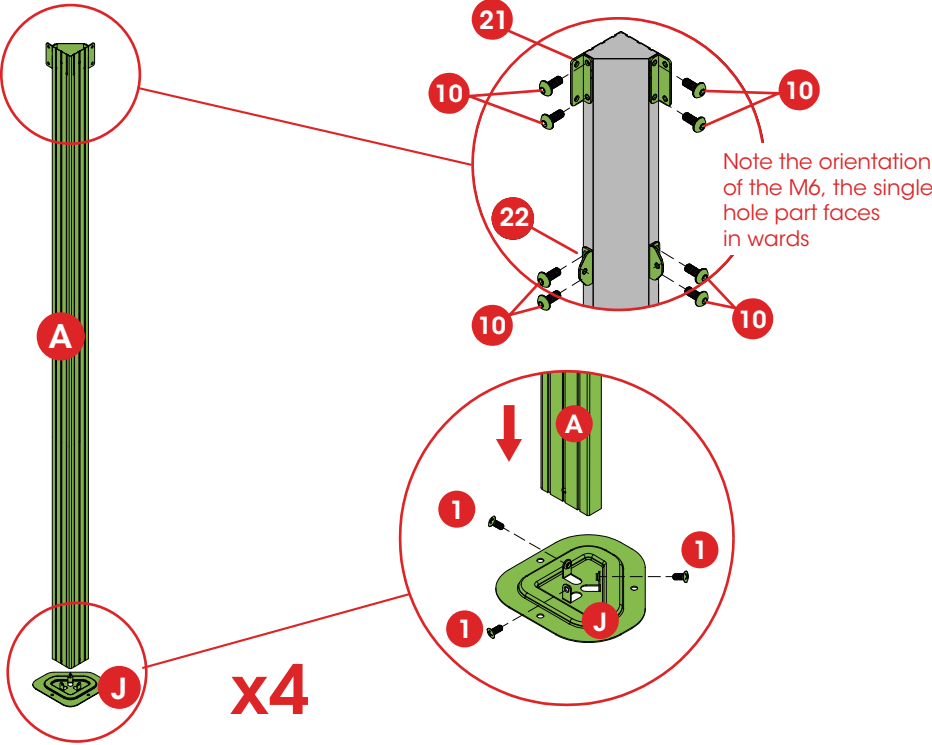
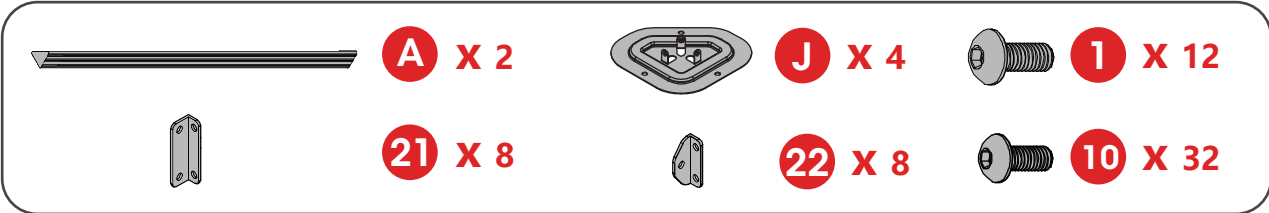

2

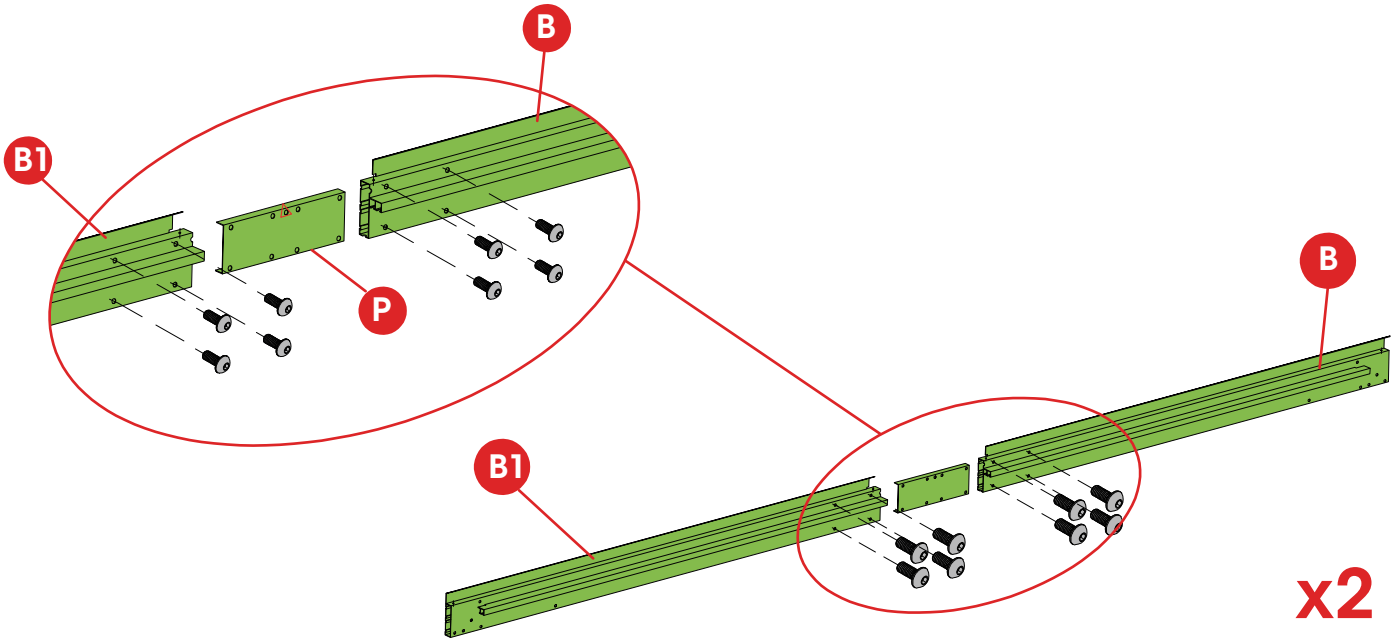
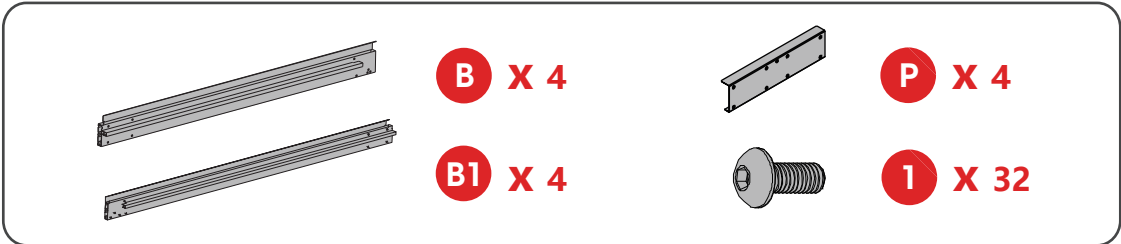

x2

3

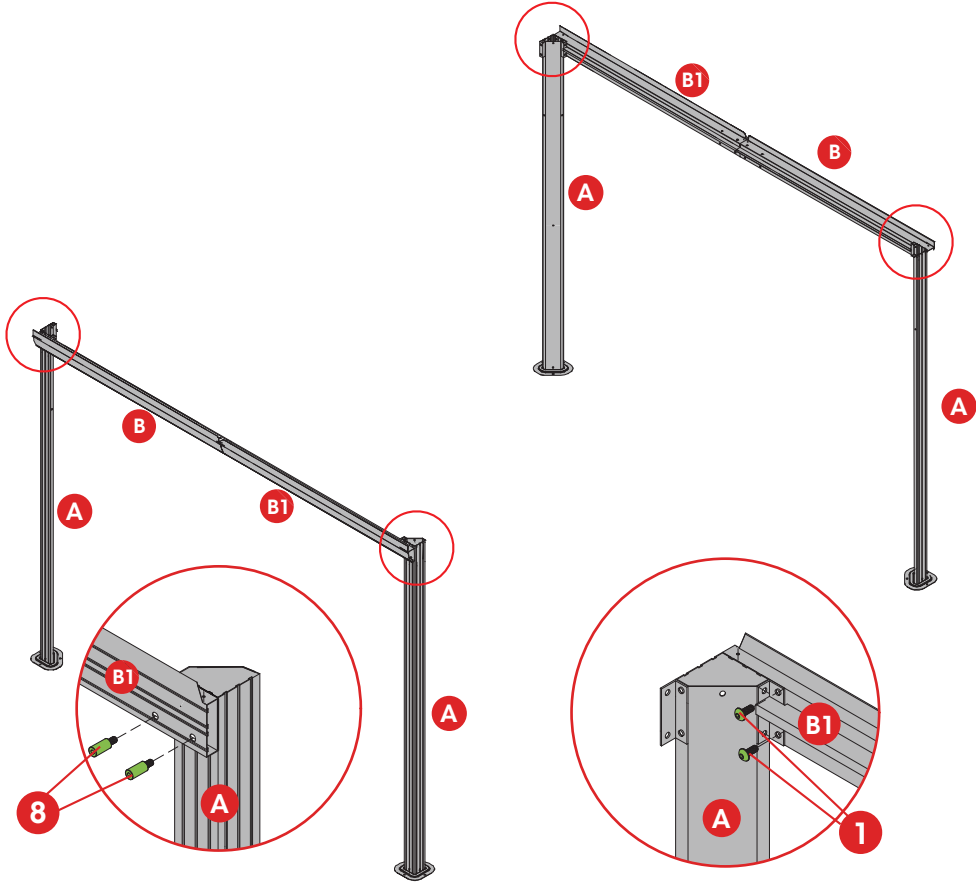

4

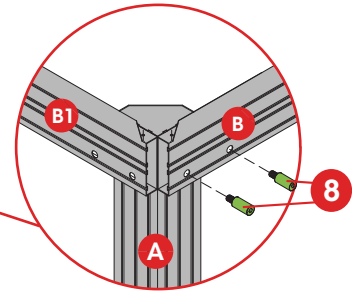
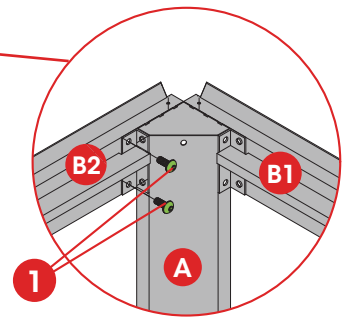
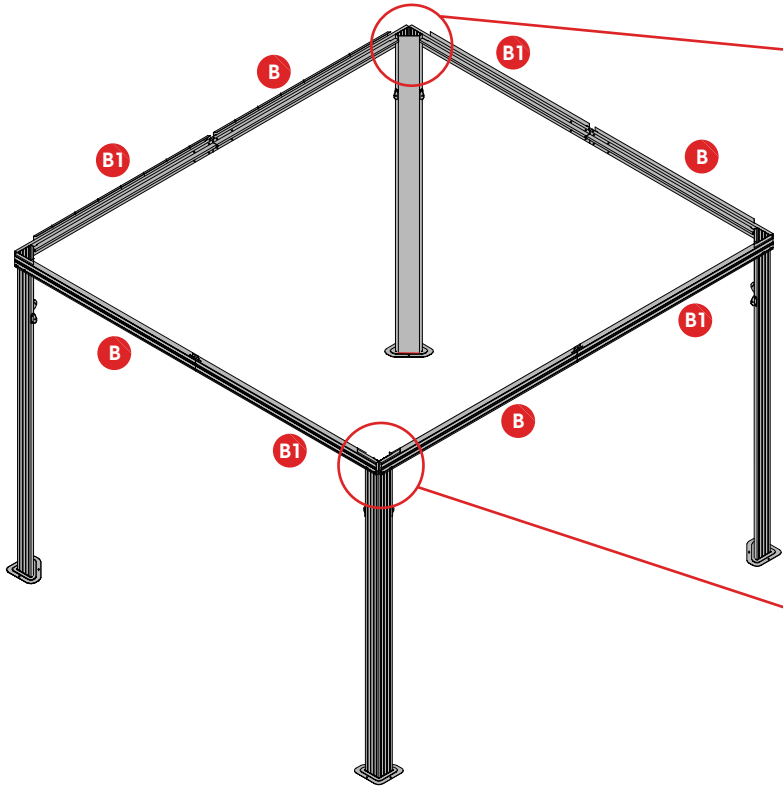

5

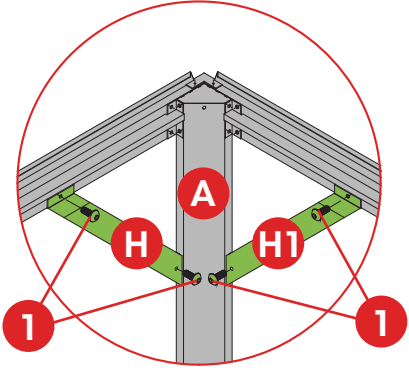
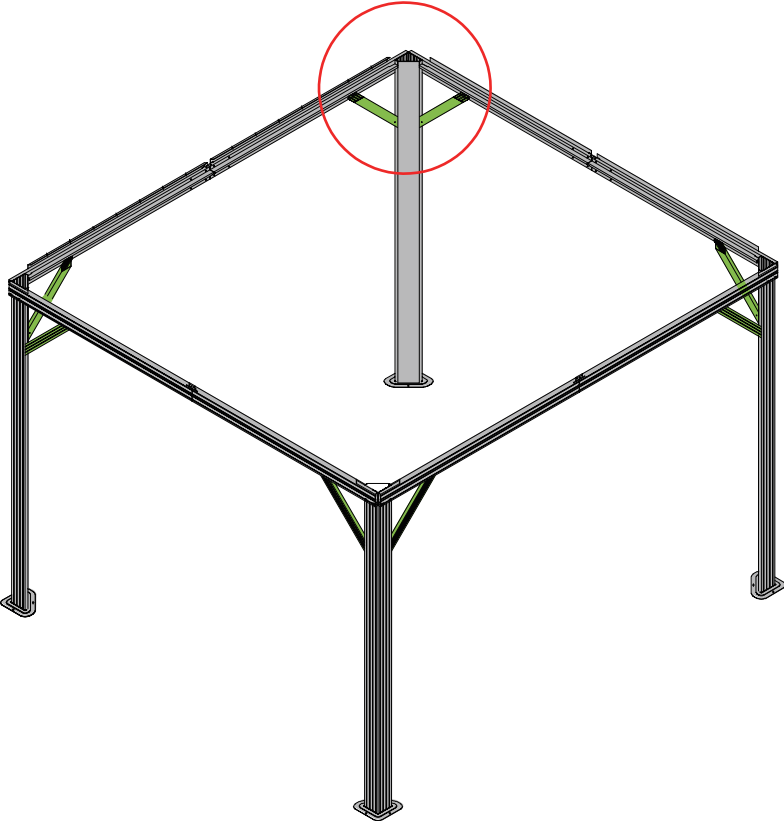

6

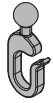



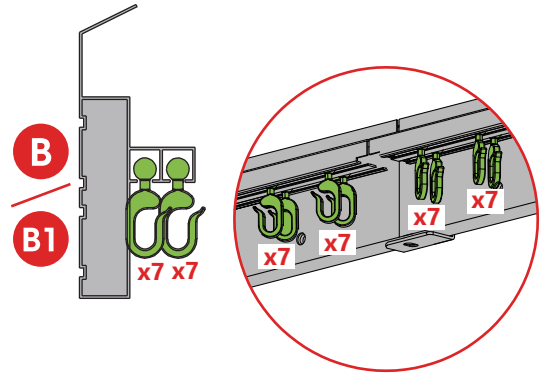
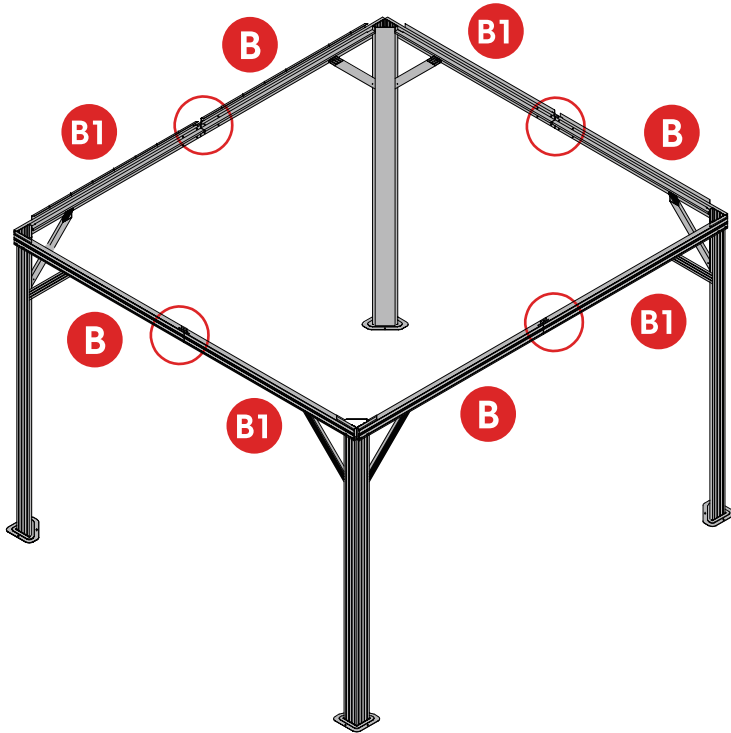

U X 112

Sliding hook 7 x U onto each rail of parts B and B1.





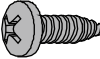

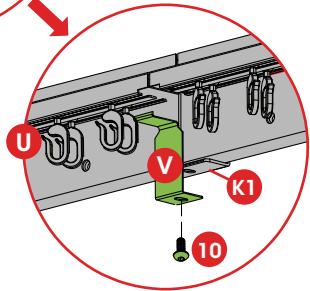
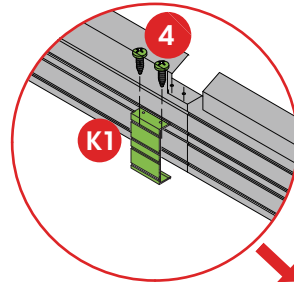
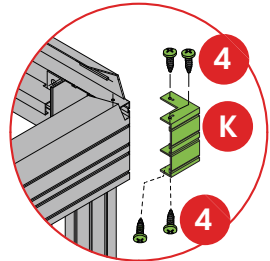
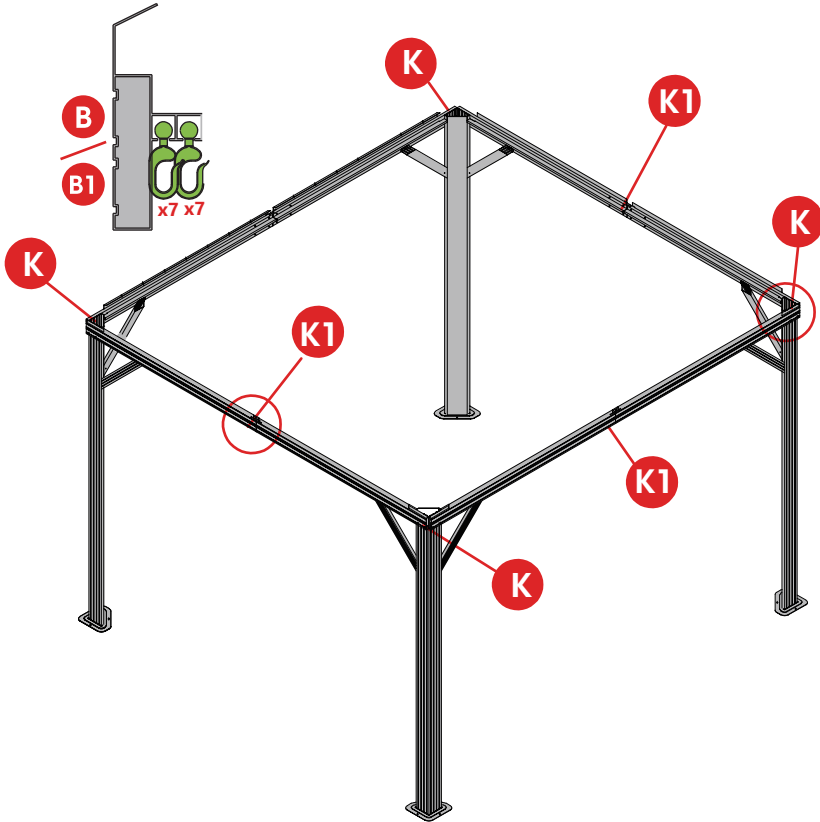

7

	V X 4		K X 4		K1 X 4
	U X 112		10 X 4		4 X 24



8

	Ea X 4		Eb X 4		17 X 4
	16 X 12		18 X 4		W3 X 4
	10 X 8				

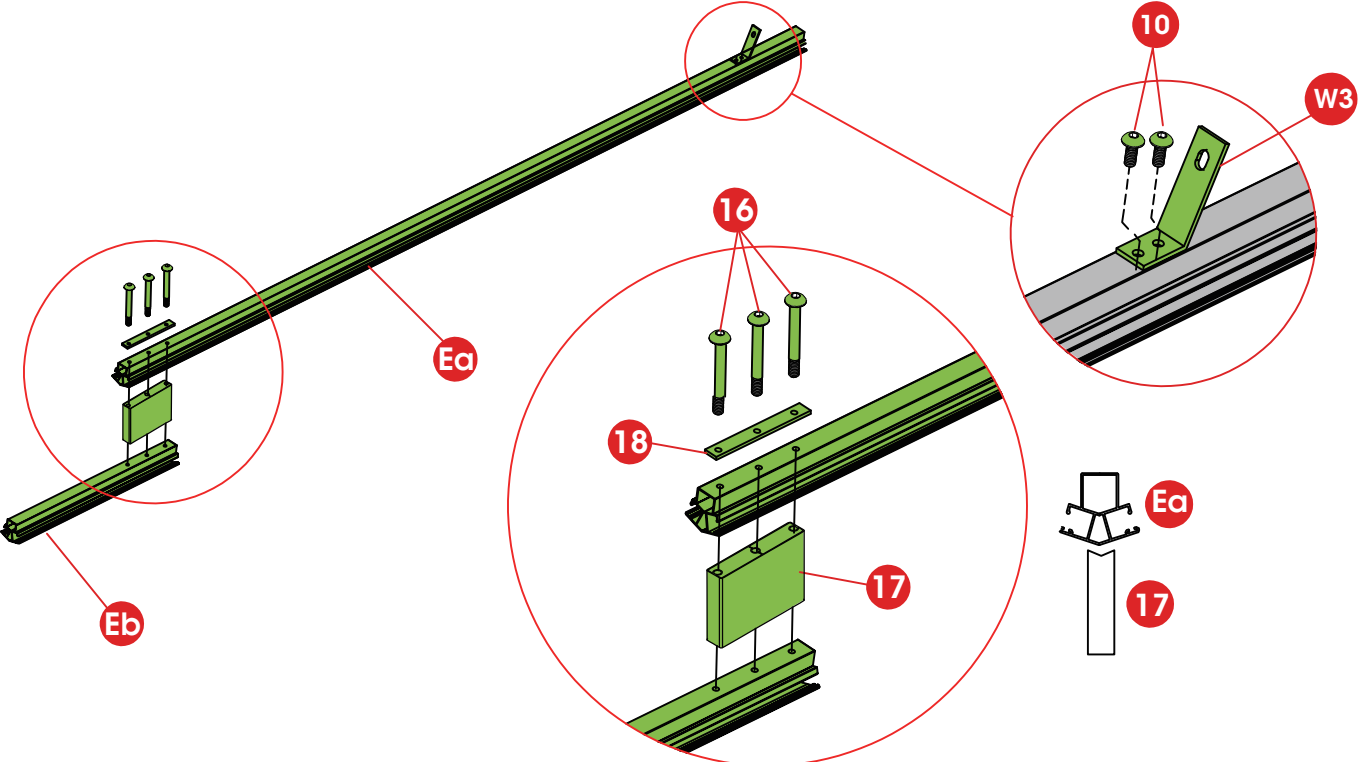

9

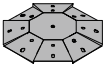
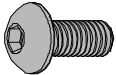
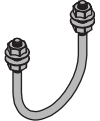
 **L** X 1  **1** X 12  **15** X 1

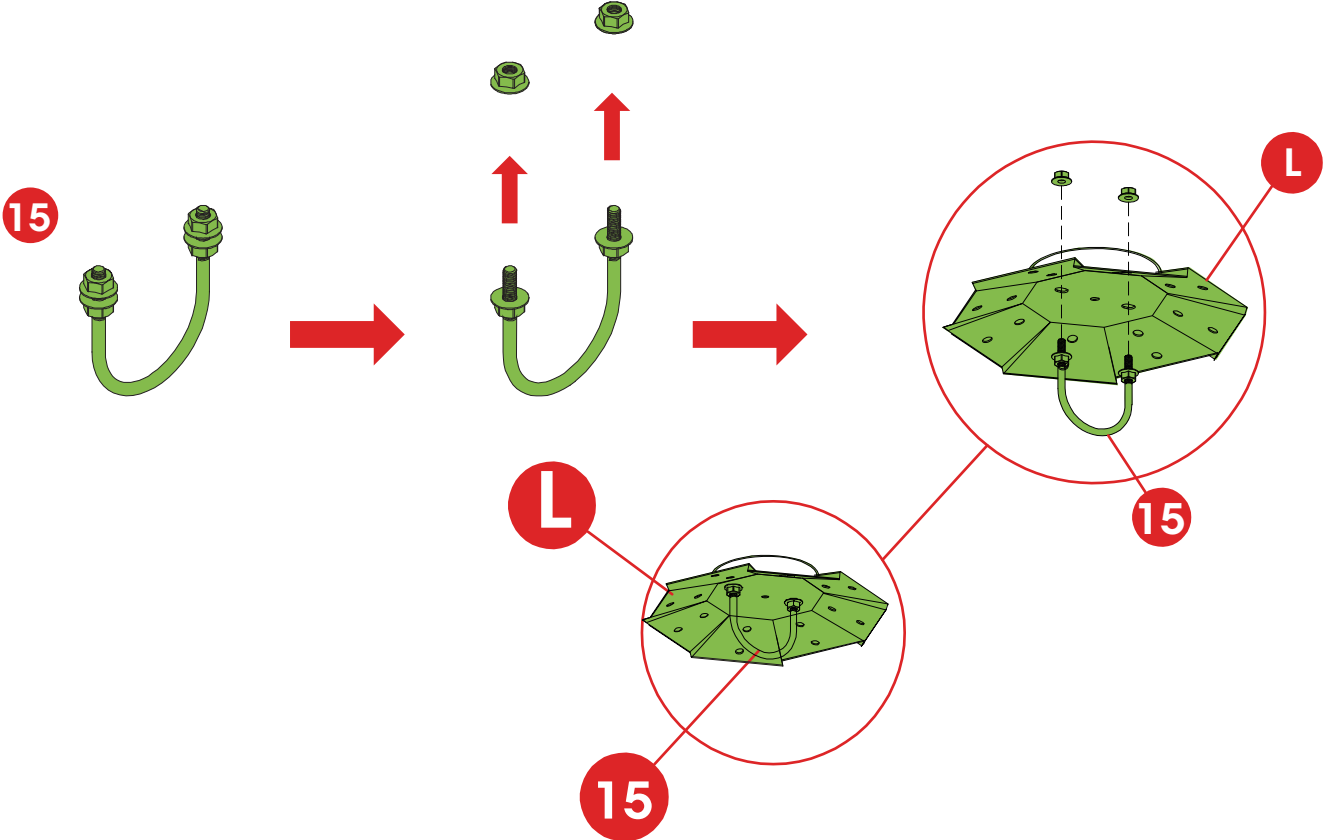

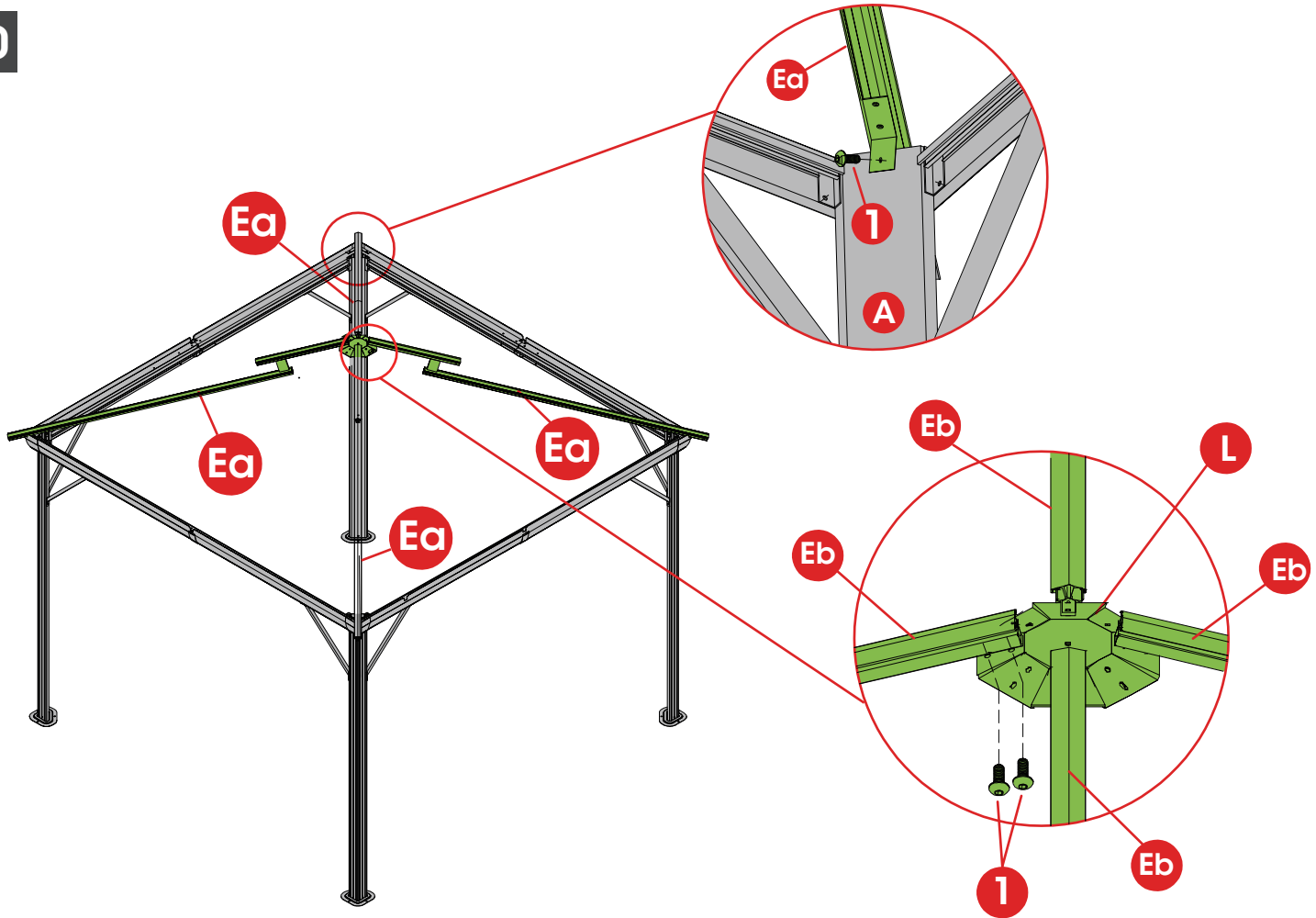

11

E1 X 4 1 X 12

E2 X 4

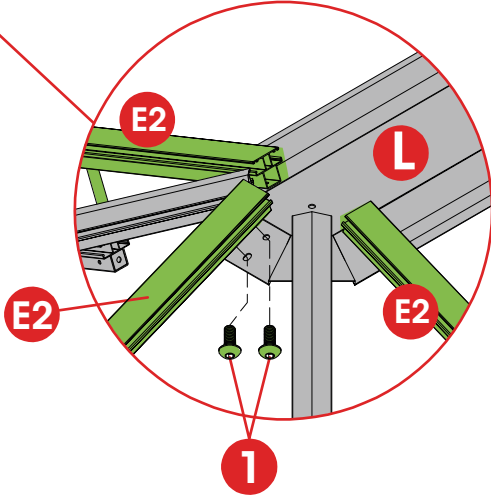
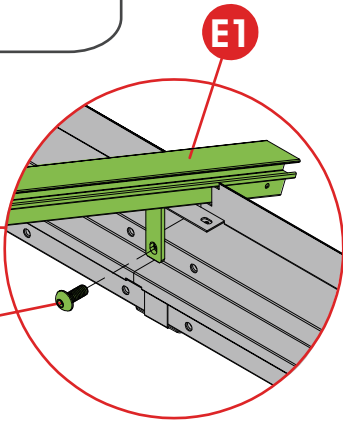
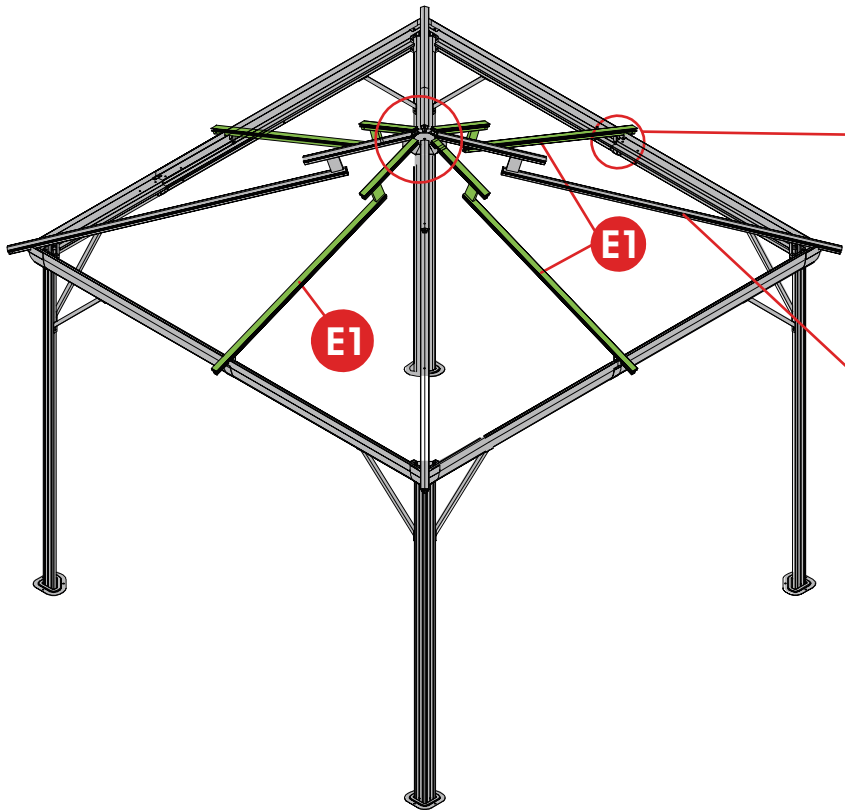

Part 4

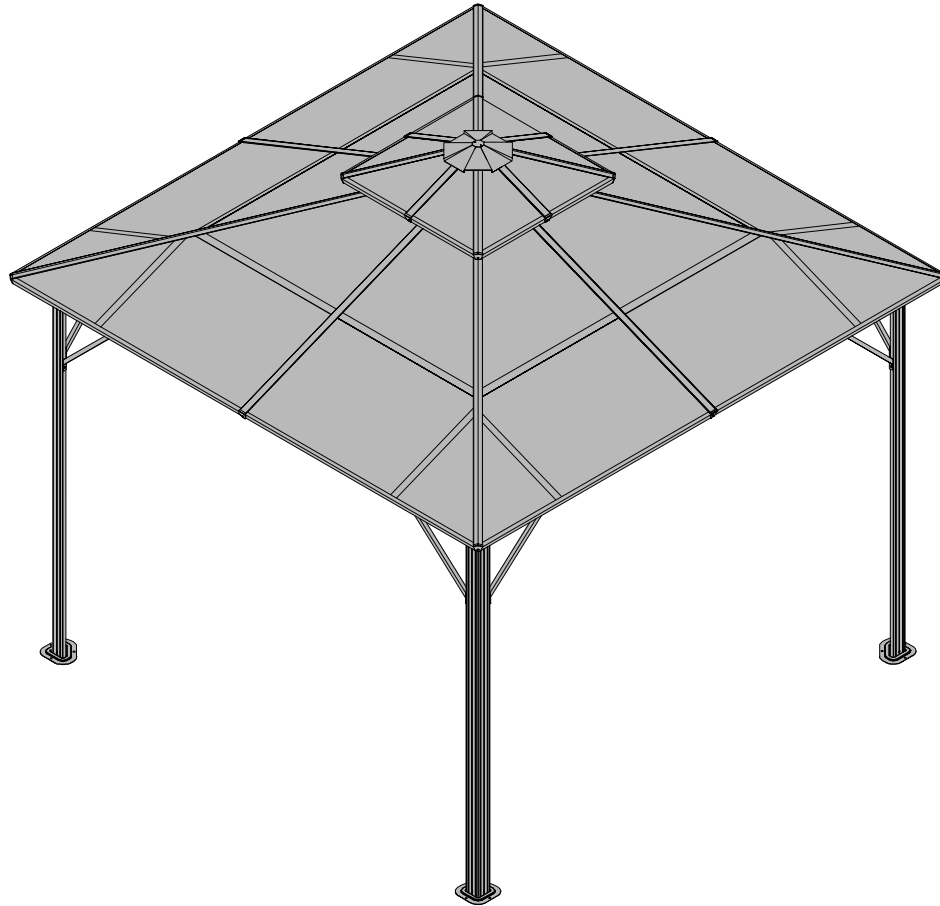

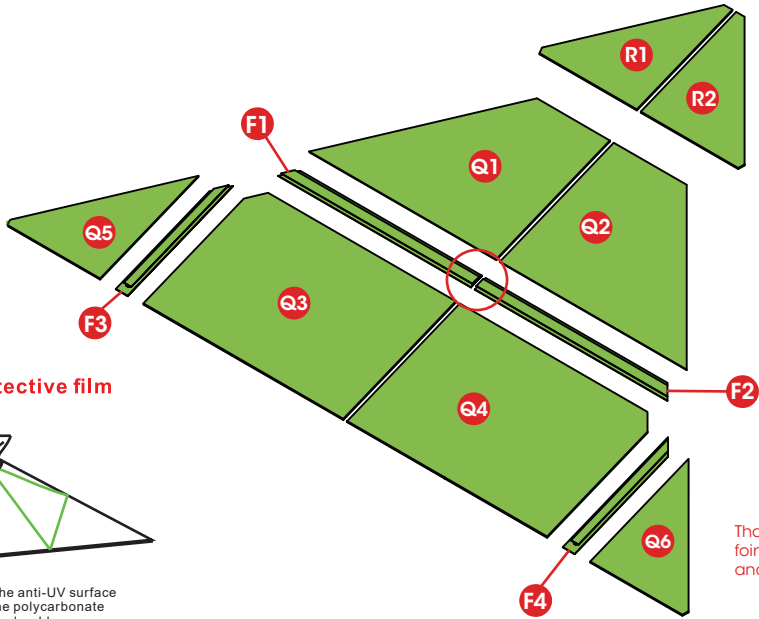
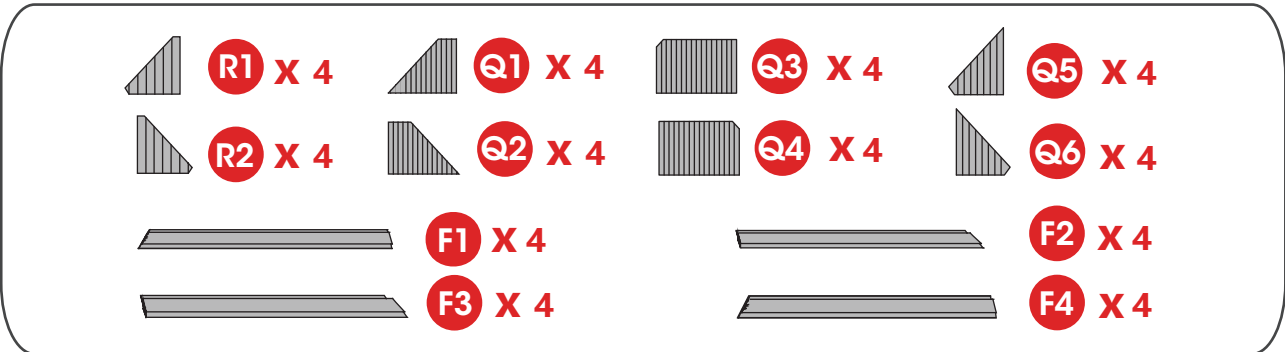

 Remove the protective film

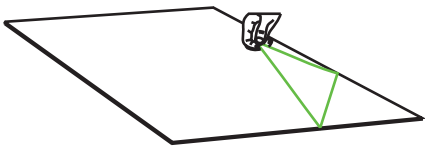

Note: When installing the product, the anti-UV surface should face outwards, preventing the polycarbonate board from aging and making it more durable.

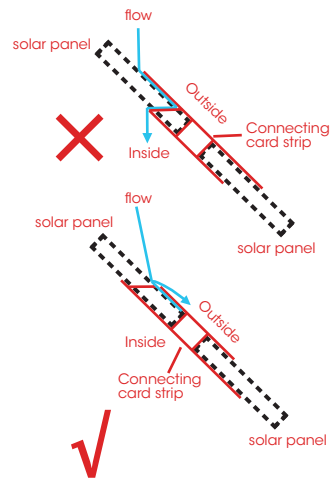

There is a film on the surface of the solar panel to indicate the front and back. Please check the front and back of each panel before removing the film.

12

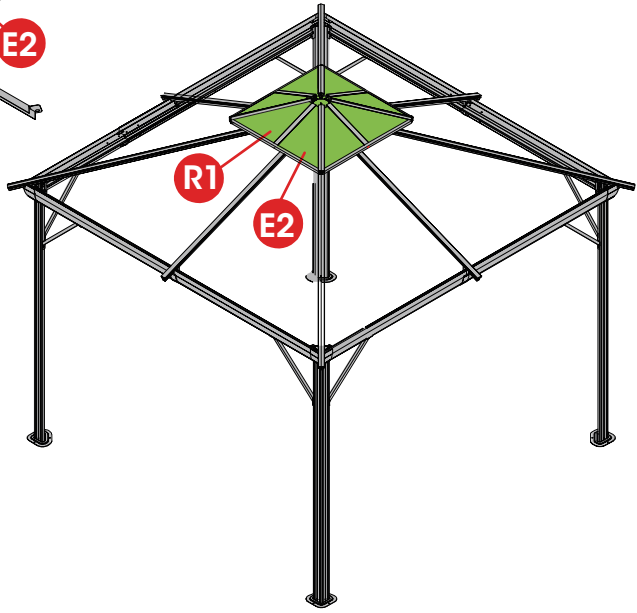
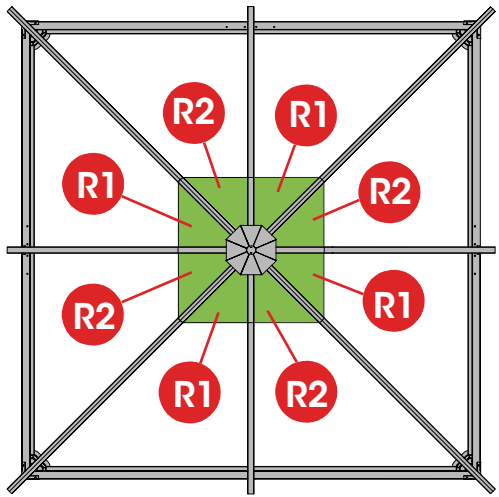
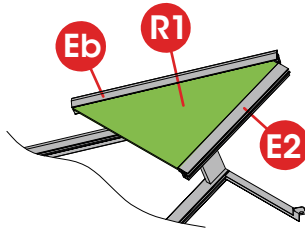
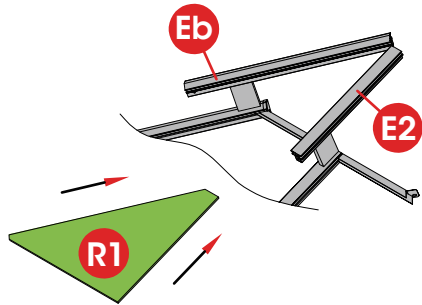

13



1 X 8



N X 4



G3 X 4

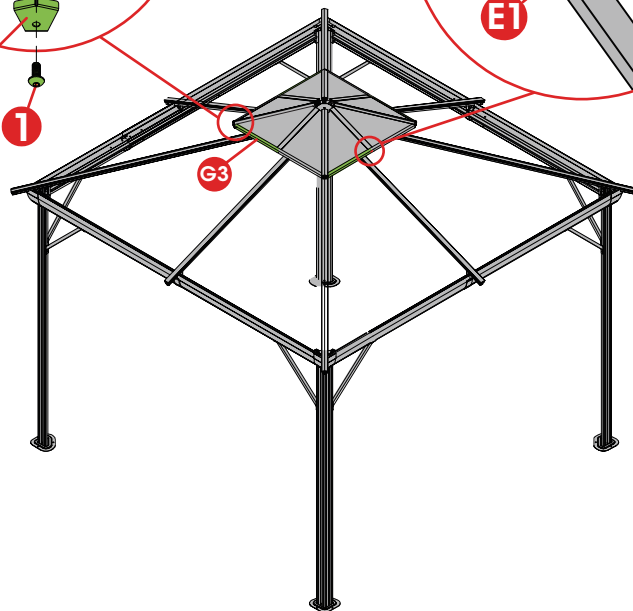
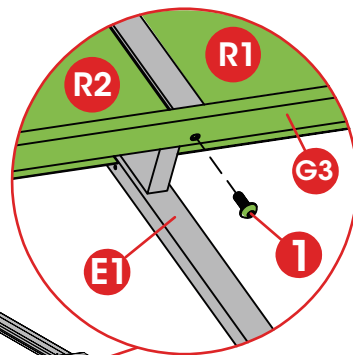
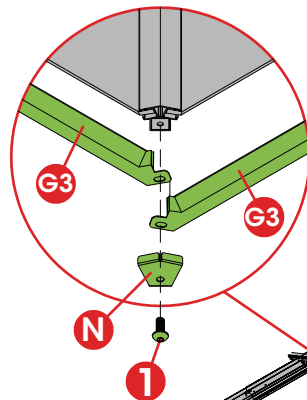
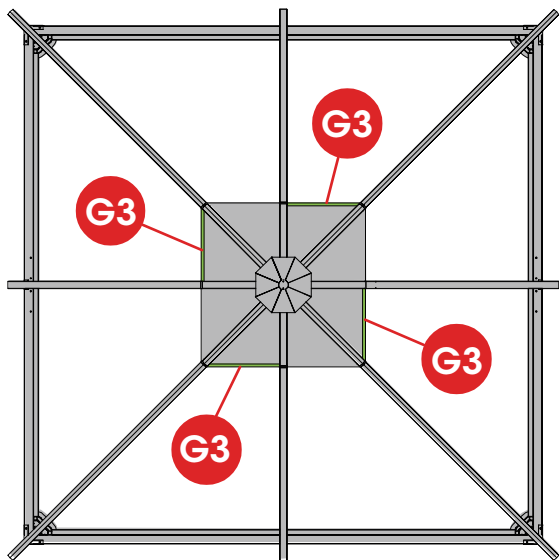

14

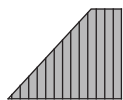

Q1 X 4

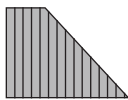

Q2 X 4



F1 X 4



F2 X 4

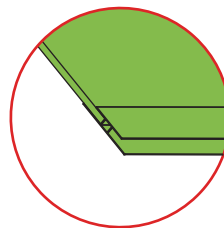
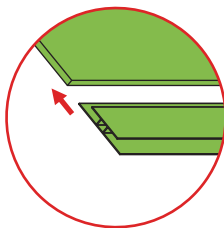
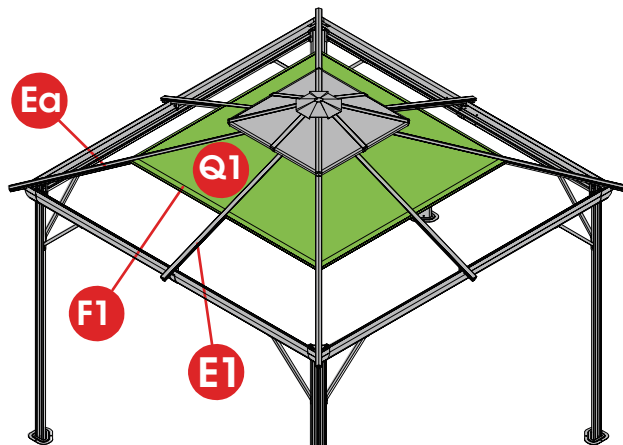
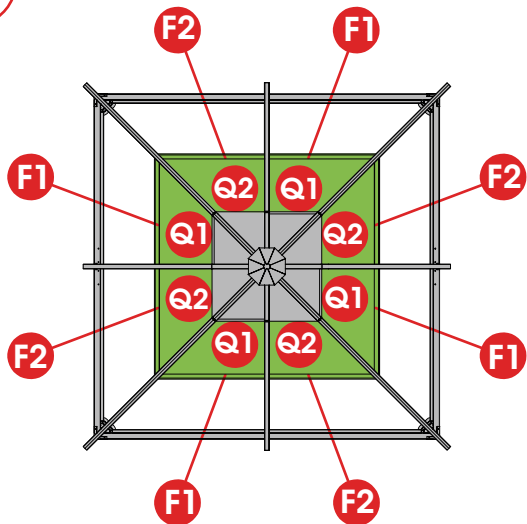
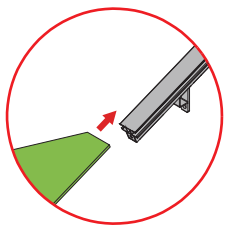
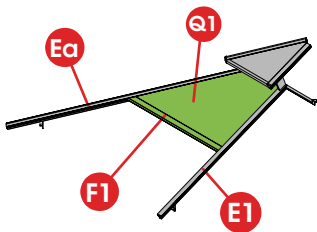
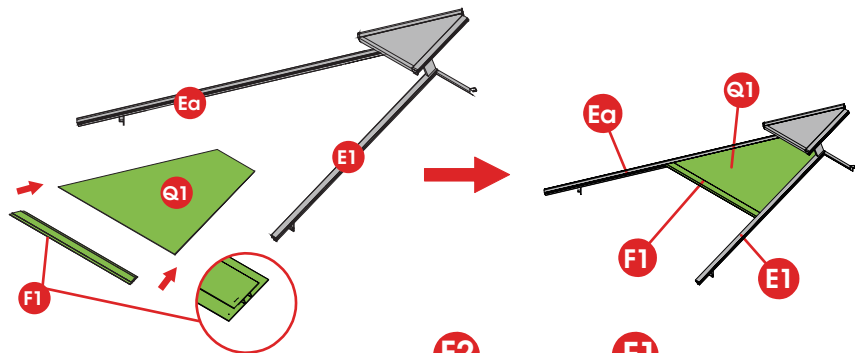

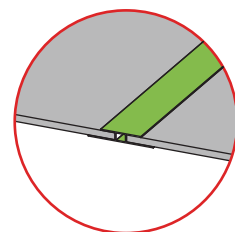
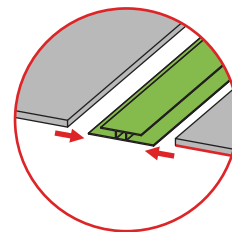
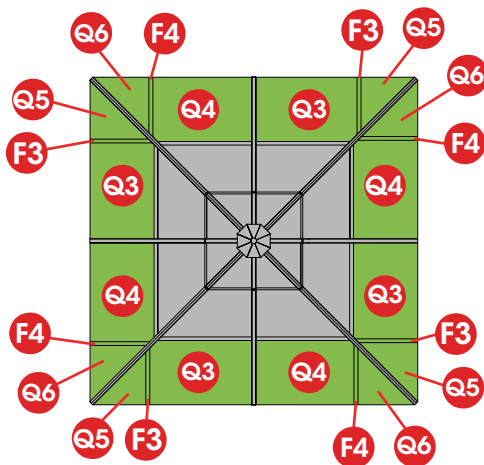
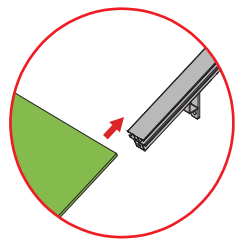
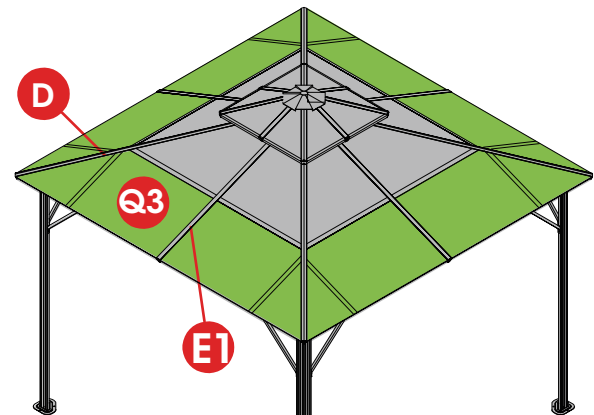
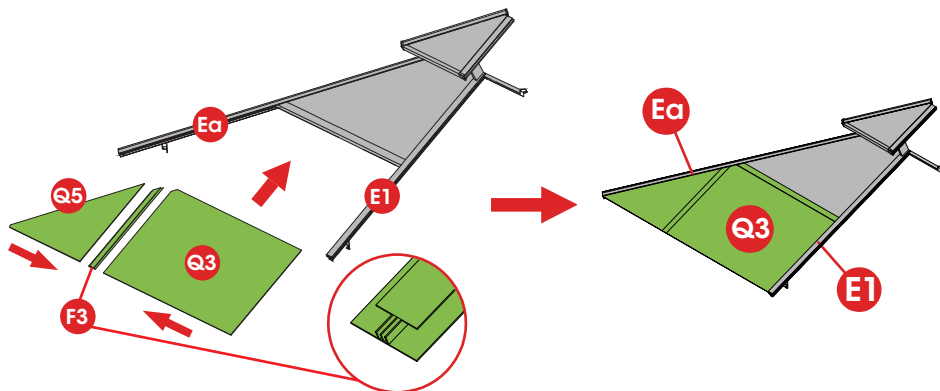

16

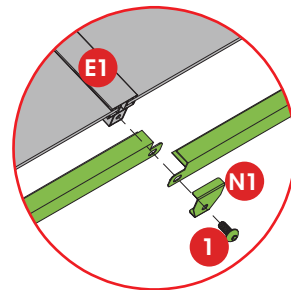
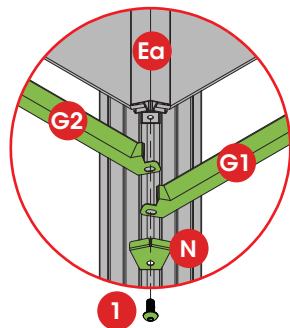
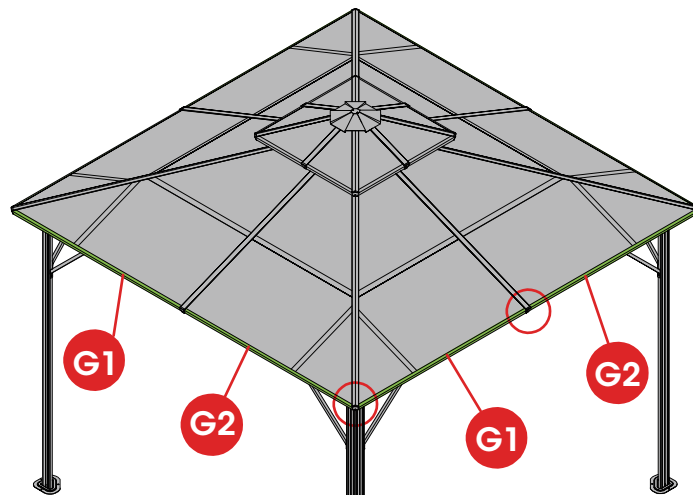
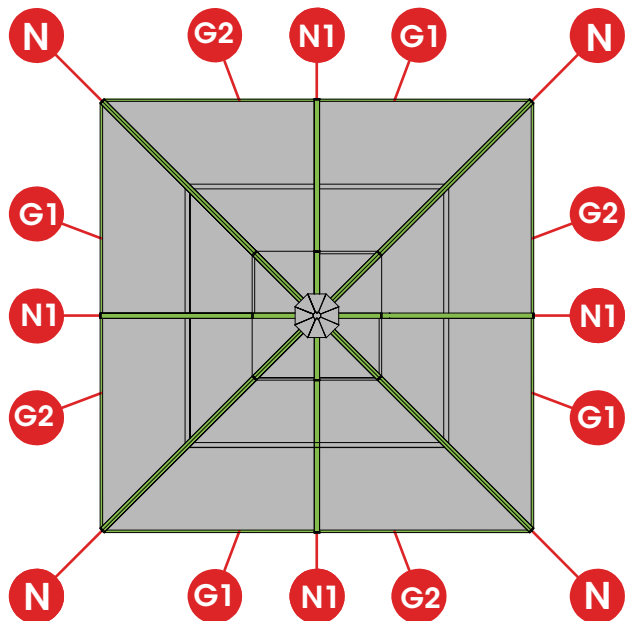
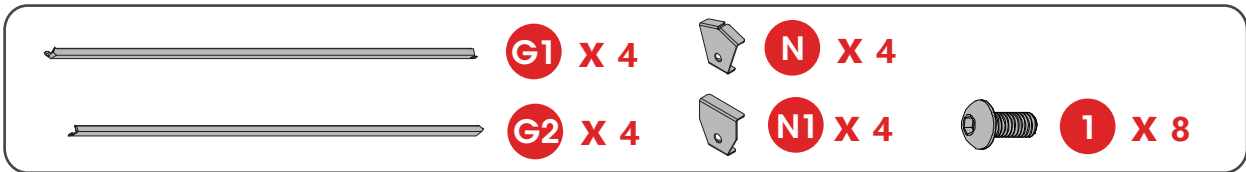

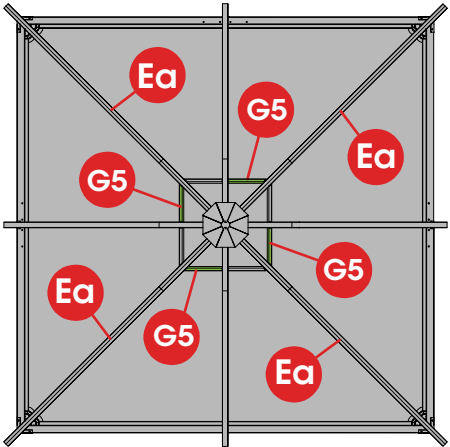
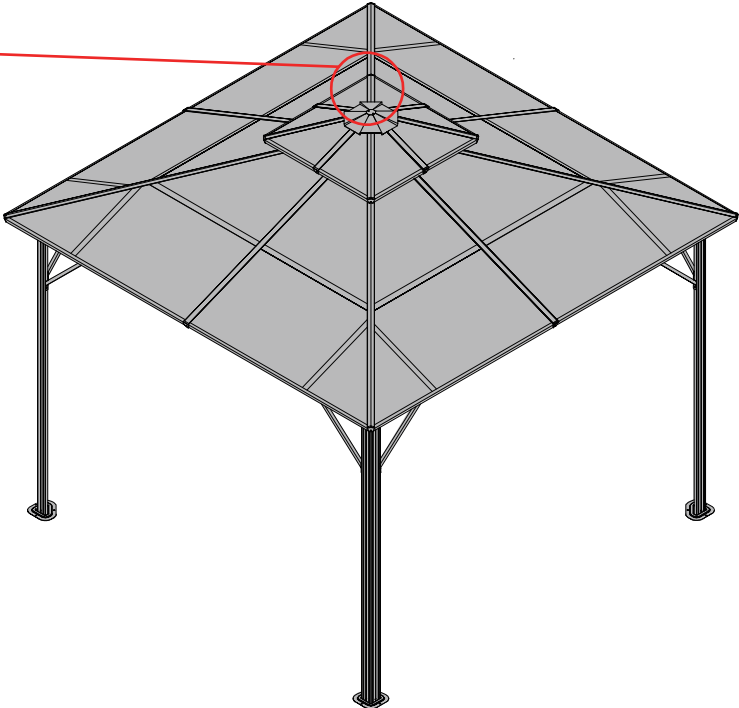
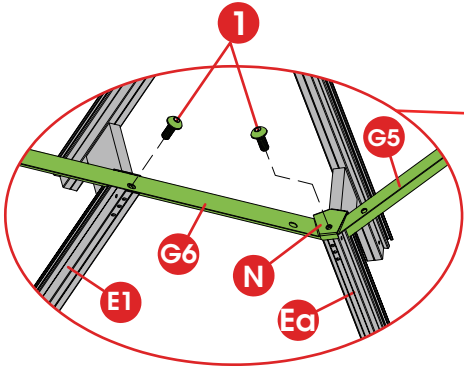
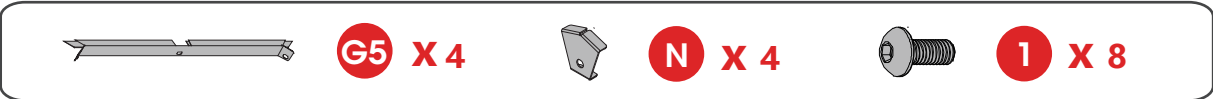

18

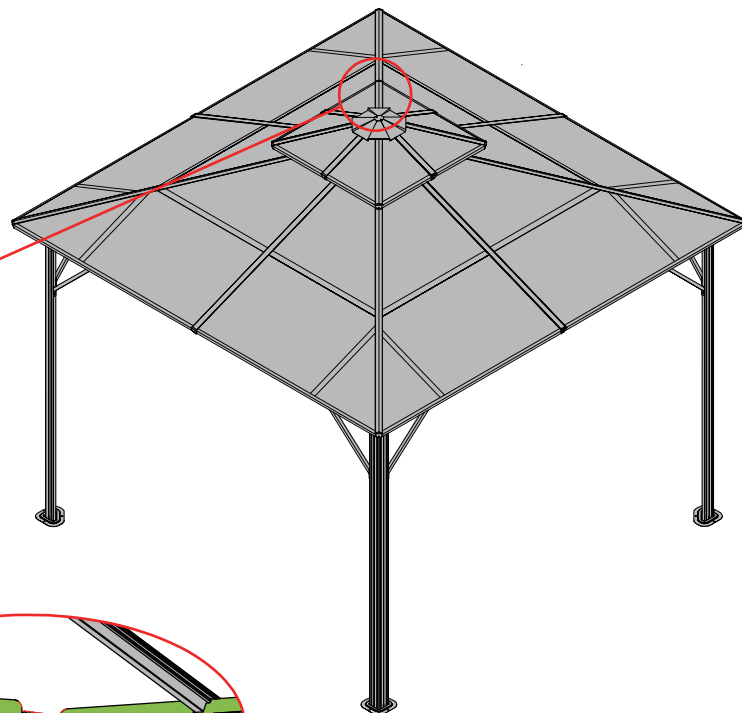
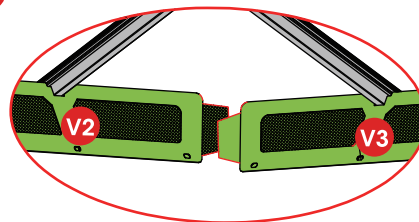
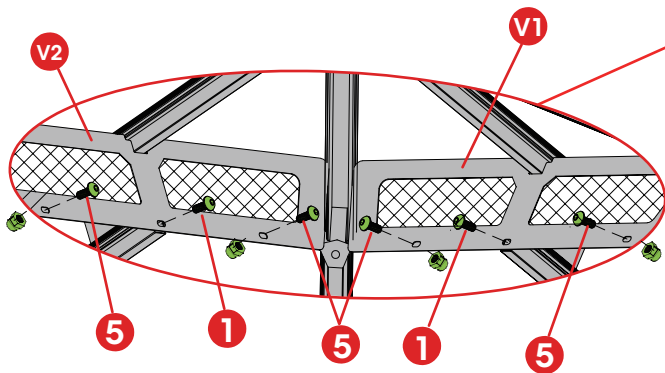
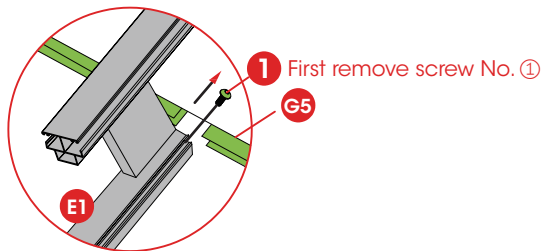
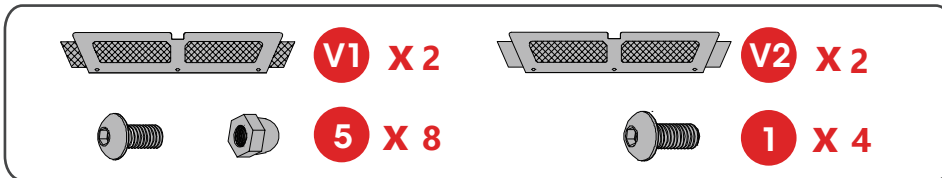

Part 5

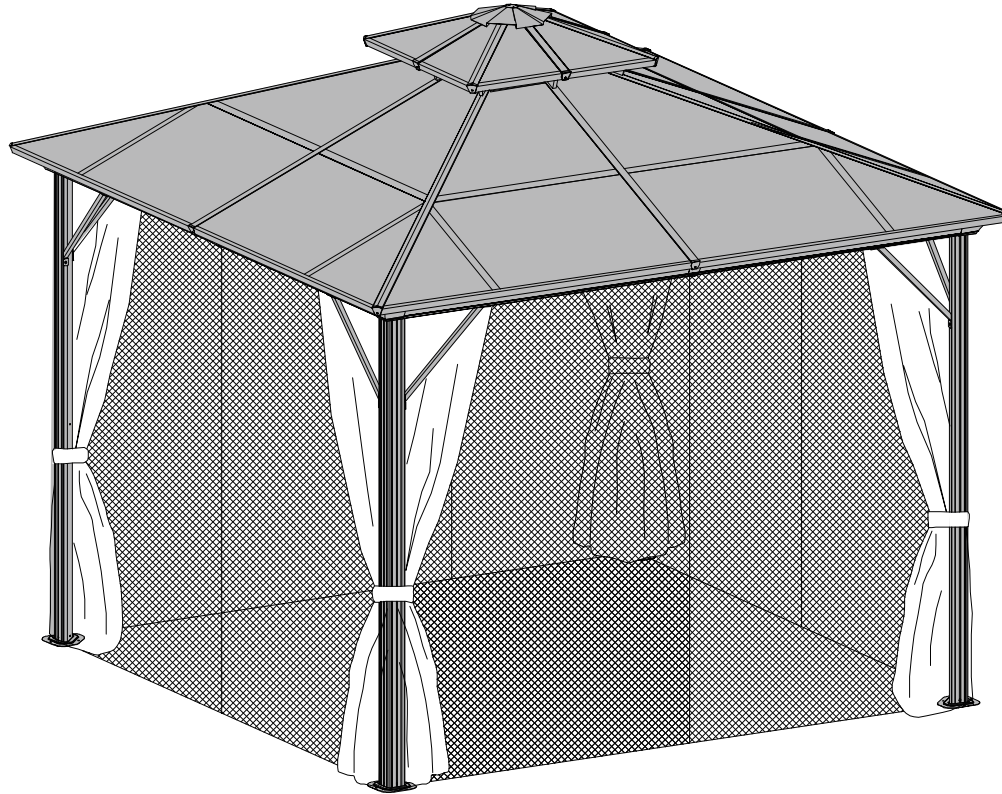

19

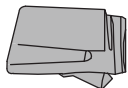

T X 1(4pcs)

Steps 19 and 20 need to be synchronized.

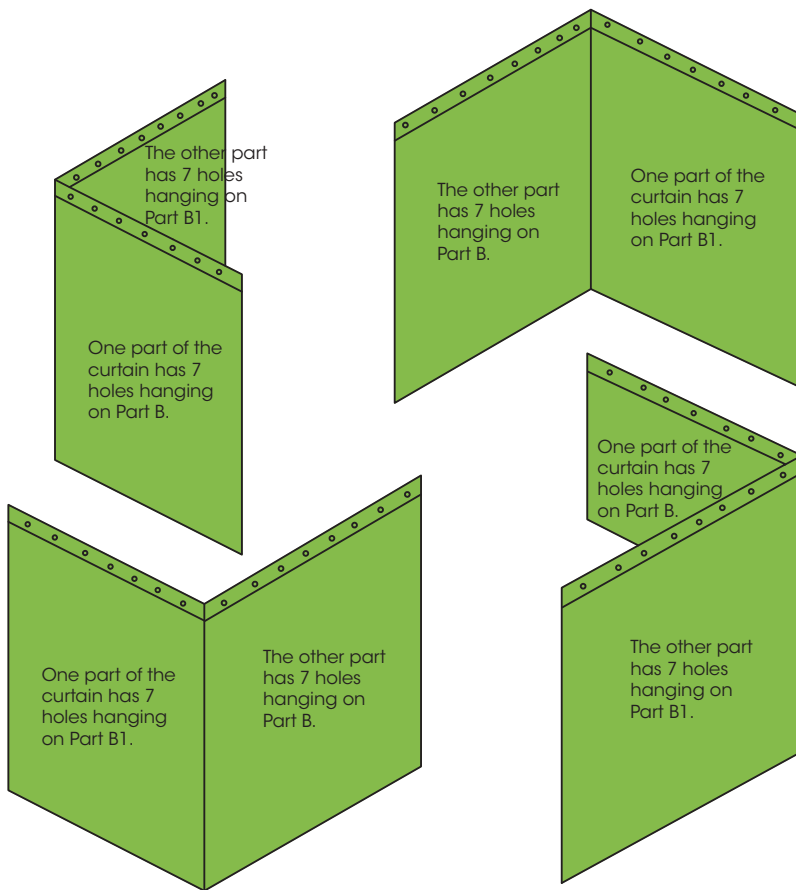
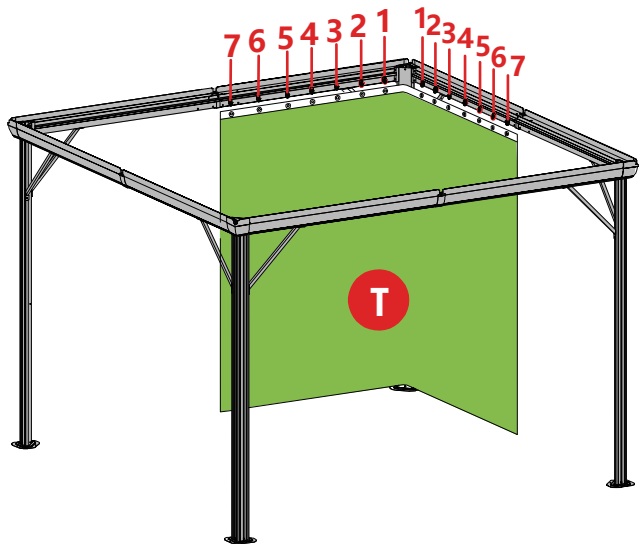

20

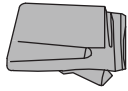

T X 1(4pcs)

Steps 19 and 20 need to be synchronized.

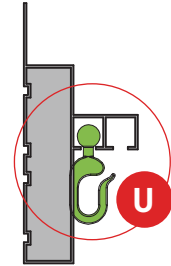
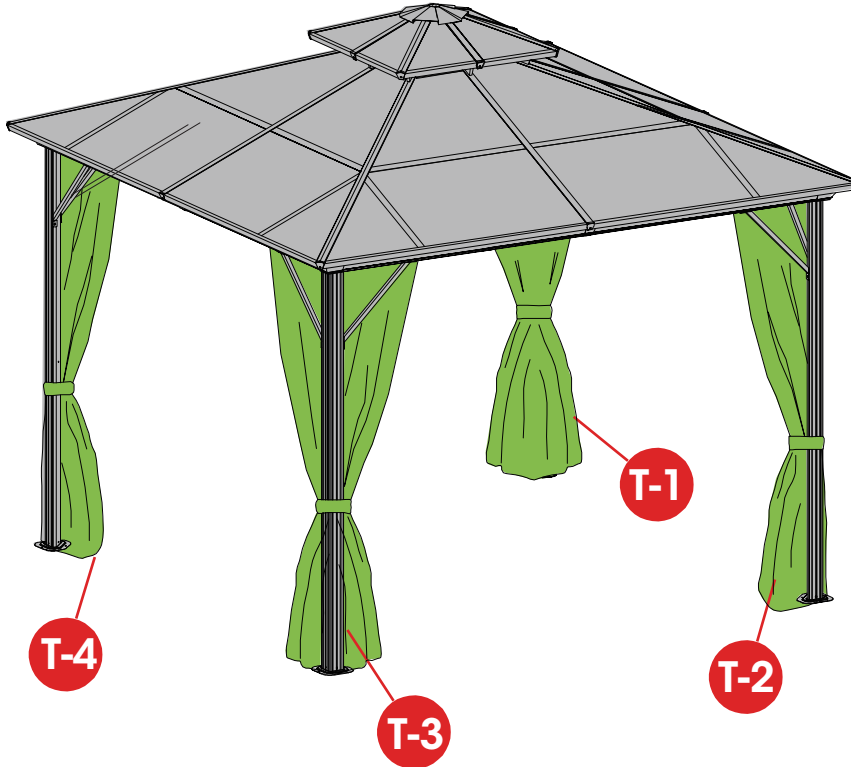

Pay attention to the sidewall curtain's installation position.

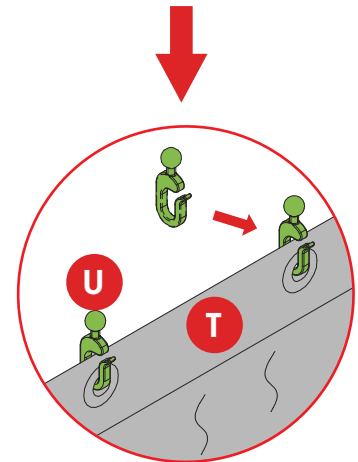

21

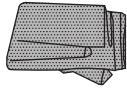

T1 X 1(4pcs)

Steps 21 and 22 need to be synchronized.

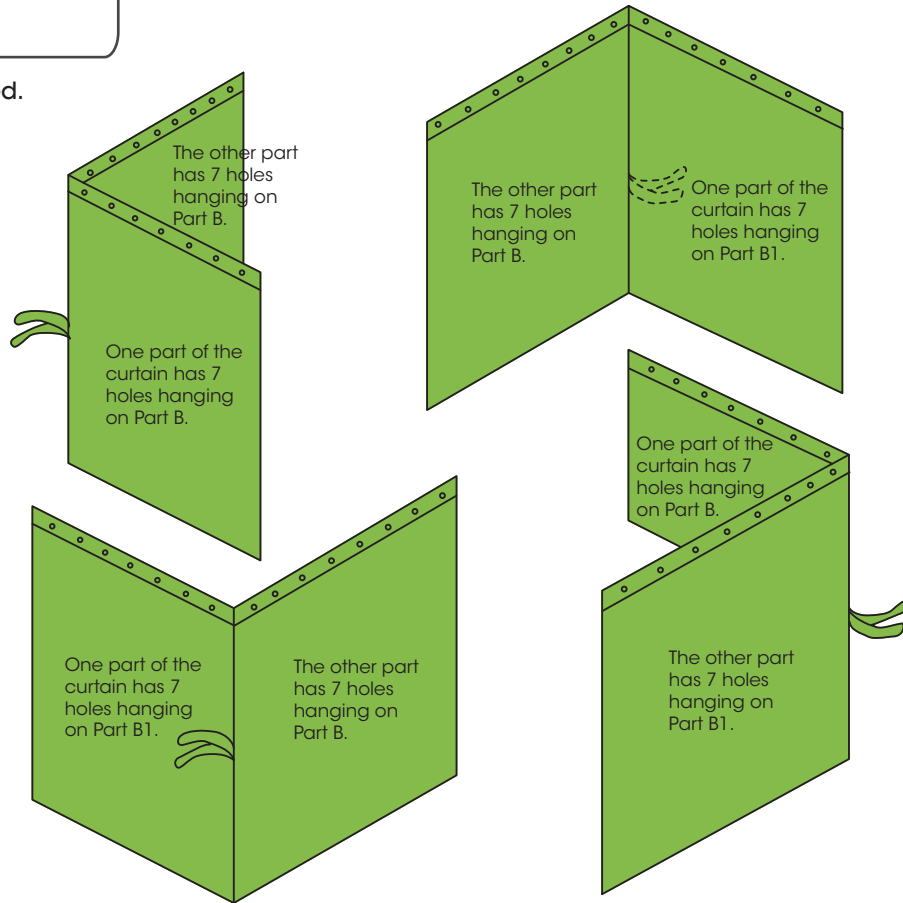
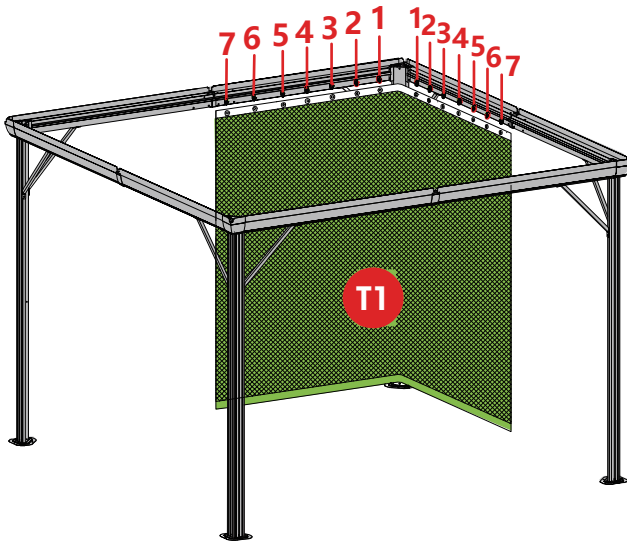



Steps 21 and 22 need to be synchronized.

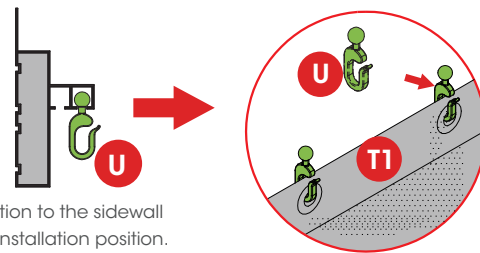
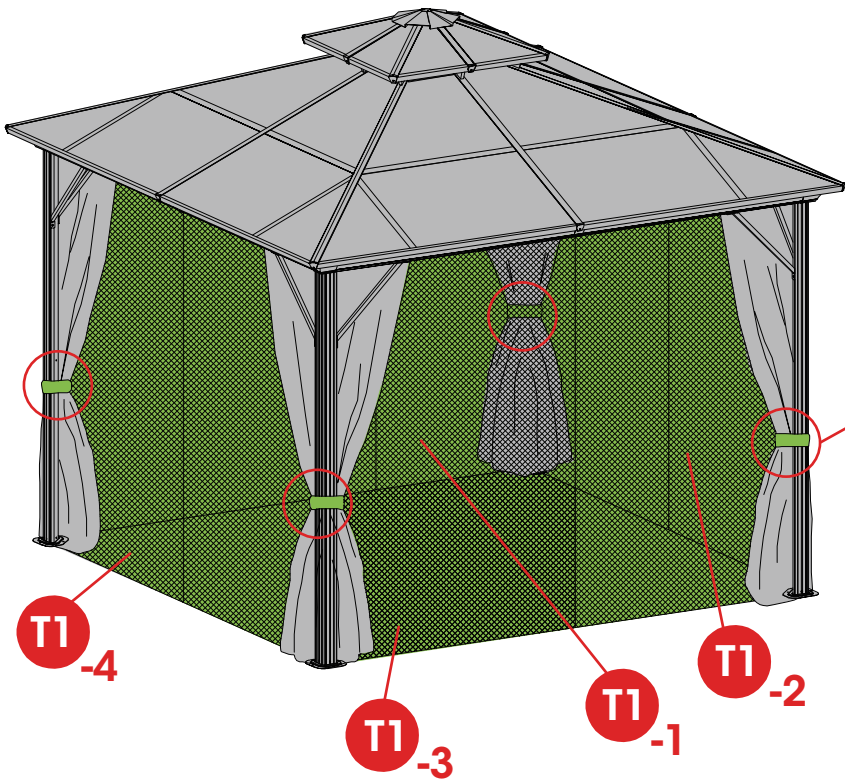

Pay attention to the sidewall netting's installation position.

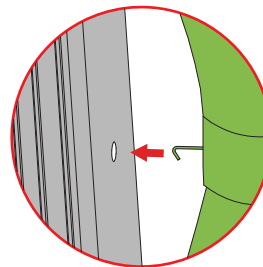
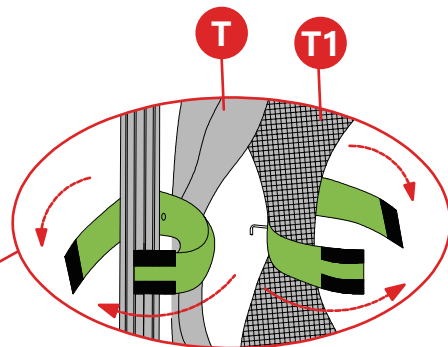

Hang the hook attached to the netting on Part A.



9 X 12



14 X 12

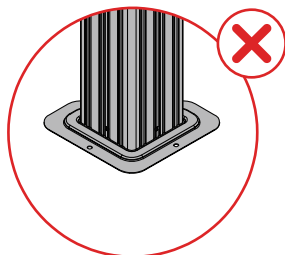
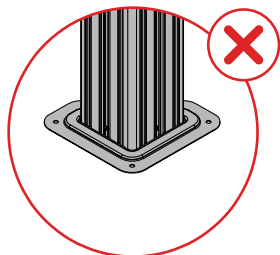
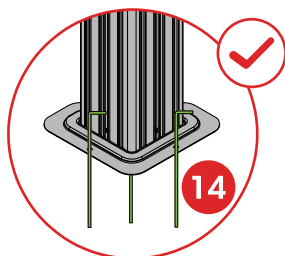
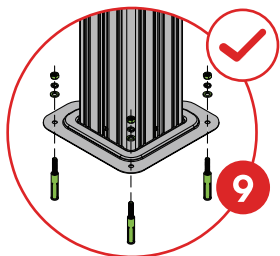

Cement surfaces

Grassy surfaces

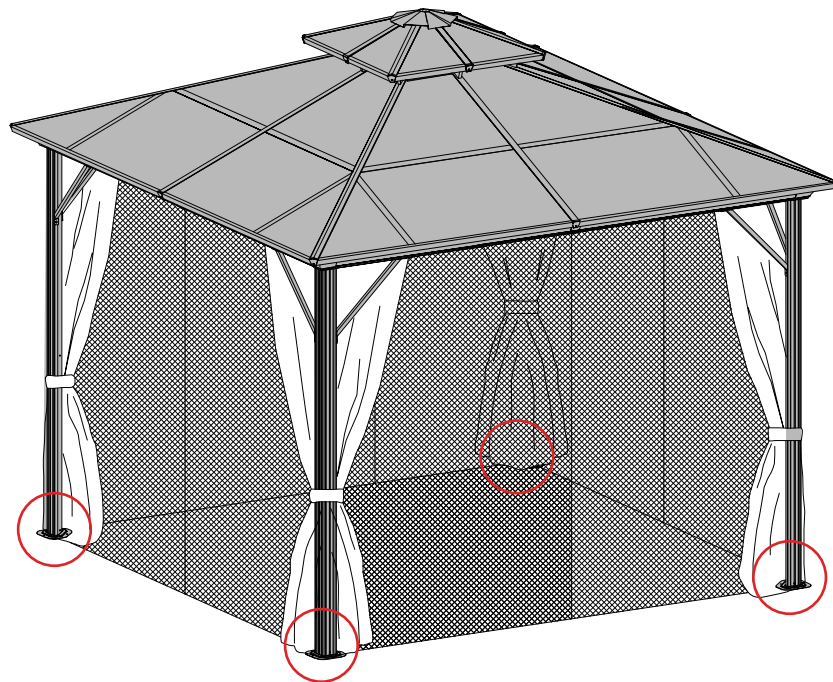

Installation Completed



To improve wind resistance, **be sure to complete this installation step. If expansion screws or ground nails are not installed, strong winds may topple the gazebo.** Expansion screws are essential for stability on cement surfaces, and ground nails are for grassy surfaces. All are included in the accessories package.

HELP CENTER

Question about your product? We're here to help. Visit us at:

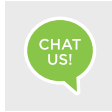

Chat Support



Product Inquiry

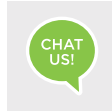

Orders FAQ



Product Assembly

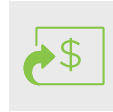

Returns & Refunds

We Stand Behind the Quality of Their Furniture

If you have any issues with your item please let us know! We will always do our best to come up with a solution that you will be happy with. Please get in touch with our customer service team before returning the product. And pls do not throw the original box(es) if you have not finished assembling or confirmed no quality issues.

Length of return period:

Items can be returned within 30 days of purchase.

In the meanwhile, everything you purchased from us comes with a one-year warranty.

Who is responsible for the return shipping fee:

We will cover the return shipping fees if:

1. Your item has a manufacturing defect in its materials or workmanship. For example, torn wicker or misaligned screw holes. We will send you a prepaid shipping label after photos are sent.
2. Your item has been damaged in transit. For example, glass is broken or wicker is damaged. We will send you a prepaid shipping label after photos are sent.
3. You receive the wrong box(es) due to a warehouse error. We will send you a prepaid shipping label after photos are sent of the wrong SKU numbers on the outer box(es).
4. One or more boxes are lost in transit. We will send you a prepaid shipping label if you no longer want the item.

*However, we still hope to work with you for a better solution instead of a return. Please don't hesitate to contact our customer service team.

Customer will cover the return shipping fees if:

1. You don't like the product(s) after receiving the box(es).
2. You no longer need the product(s) but you have received the box(es).
3. You buy the product(s) by mistake but you have received the box(es).
4. Order/shipment cancellation failed and you have received the box(es).

Return Request

In order to get a full refund as described in this return policy, all items must be: (1) In a brand new/unused condition, please provide photos before and after packaging.

(2) When returning, all accessories and parts are firmly packed in all original packaging.

If your return does not meet the requirements, you may not get a full refund.

When will I be refunded?

The refund is released once the goods have been returned to our warehouse.

What if the product is damaged/defective outside of the valid return period?

We want you to be a happy customer. Please reach out to us by email and we will come up with a solution to make sure you are satisfied.

Reach us at

 service@kmcglobe-us.com

 (+1) 559-354-1889