

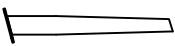

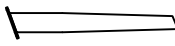

A		1
B		2
C		2
D	 M6*15	12
E	 φ13*φ6.5*1.0	12
F		1



②

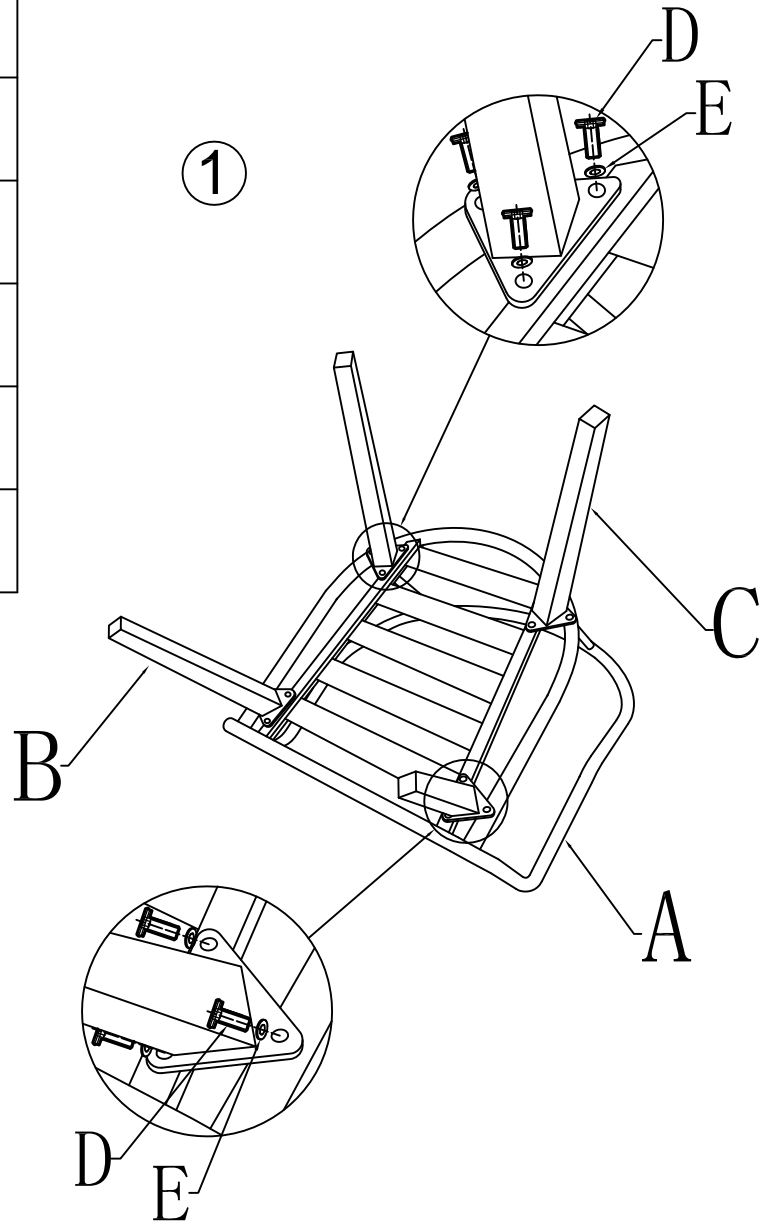