





























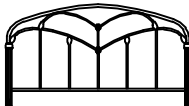
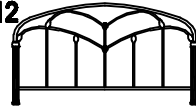
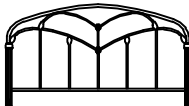
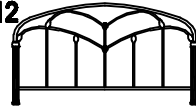

## Parts List

<b>HEADBOARD CARTON</b>															
<b>(11) HEADBOARD PANEL</b>															
<b>HARDWARE BAG FOR FRAME ATTACHMENT</b>															
<p>(1) 1/4-20 X 2 1/2" FLAT ALLEN HEAD SCREW-4</p> <p>(3) 1/4-20 X 3/4" FLAT ALLEN HEAD SCREW-4</p> <p>(4) 1/4" (ID) FLAT METAL WASHER - 8</p> <p>(5) 1/4" (ID) LOCK METAL WASHER - 4</p> <p>(6) 1/4 - 20 HEX NUTS - 4</p> <p>(7) ALLEN WRENCH- 1</p> <p>(8) OPEN END WRENCH-1</p> <p>(9) LEG. EXTENSIONS - 2</p> <p>(10) PLASTIC GLIDES - 4</p>															
<b>NOTE: GLIDES COME PRE-INSERTED</b>															
<table border="1" style="width: 100%; border-collapse: collapse; text-align: center;"> <tr> <td style="width: 25%; padding: 5px;">1 </td> <td style="width: 25%; padding: 5px;">2 </td> <td style="width: 25%; padding: 5px;">3 </td> <td style="width: 25%; padding: 5px;">4 </td> </tr> <tr> <td style="padding: 5px;">5 </td> <td style="padding: 5px;">6 </td> <td style="padding: 5px;">7 </td> <td style="padding: 5px;">8 </td> </tr> <tr> <td colspan="2" style="padding: 5px;">9 </td> <td colspan="2" style="padding: 5px;">10 </td> </tr> </table>	1 	2 	3 	4 	5 	6 	7 	8 	9 		10 		<table border="1" style="width: 100%; border-collapse: collapse; text-align: center;"> <tr> <td style="width: 50%; padding: 5px;">11 </td> <td style="width: 50%; padding: 5px;">12 </td> </tr> </table>	11 	12 
1 	2 	3 	4 												
5 	6 	7 	8 												
9 		10 													
11 	12 														

PRODUCT FULLY ASSEMBLED

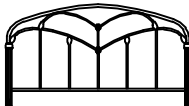
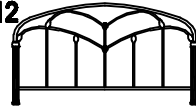
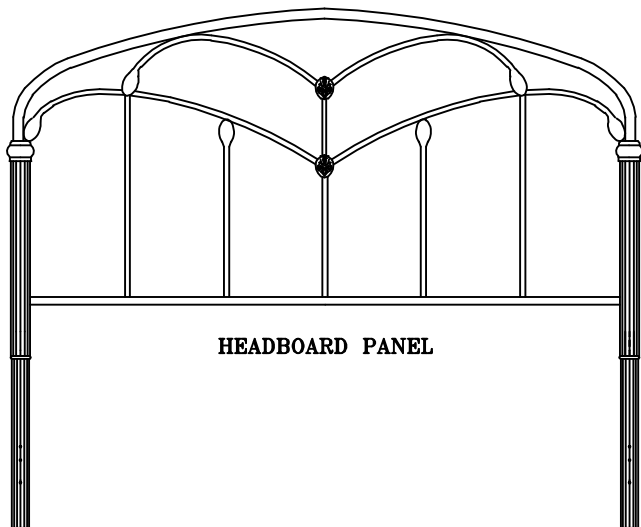

HEADBOARD PANEL

FOR ASSISTANCE IN ASSEMBLY ONLY OF THIS PRODUCT. CALL OUR HELP DESK . PLEASE HAVE THE STYLE NUMBER AVAILABLE BEFORE YOU CALL. (STYLE # OR NAME CAN BE FOUND ON PACKING CARTON OR SALES RECEIPT.) OUR PRODUCT IS INSPECTED TO ENSURE IT IS IN GOOD CONDITION. IF YOUR FURNITURE APPEARS TO HAVE BEEN DAMAGED IN SHIPMENT OR YOU ARE IN NEED OF REPLACEMENT PARTS PLEASE CONTACT THE DEALER FROM WHOM YOU PURCHASED THE PRODUCT.

# Instruction Sheet

SAVE ALL PACKAGING MATERIALS UNTIL PRODUCT IS FULLY ASSEMBLED. HARDWARE AND SMALL PIECES MAY NOT BE SEEN AND COULD BE ACCIDENTALLY DISCARDED WITH PACKAGING MATERIALS.

FIGURE 1

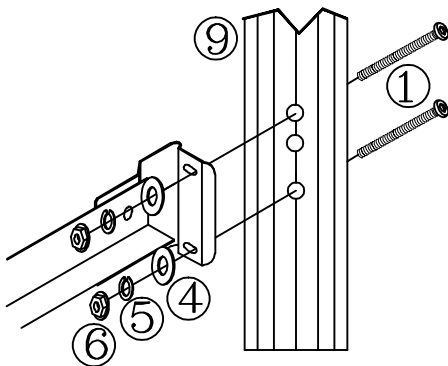
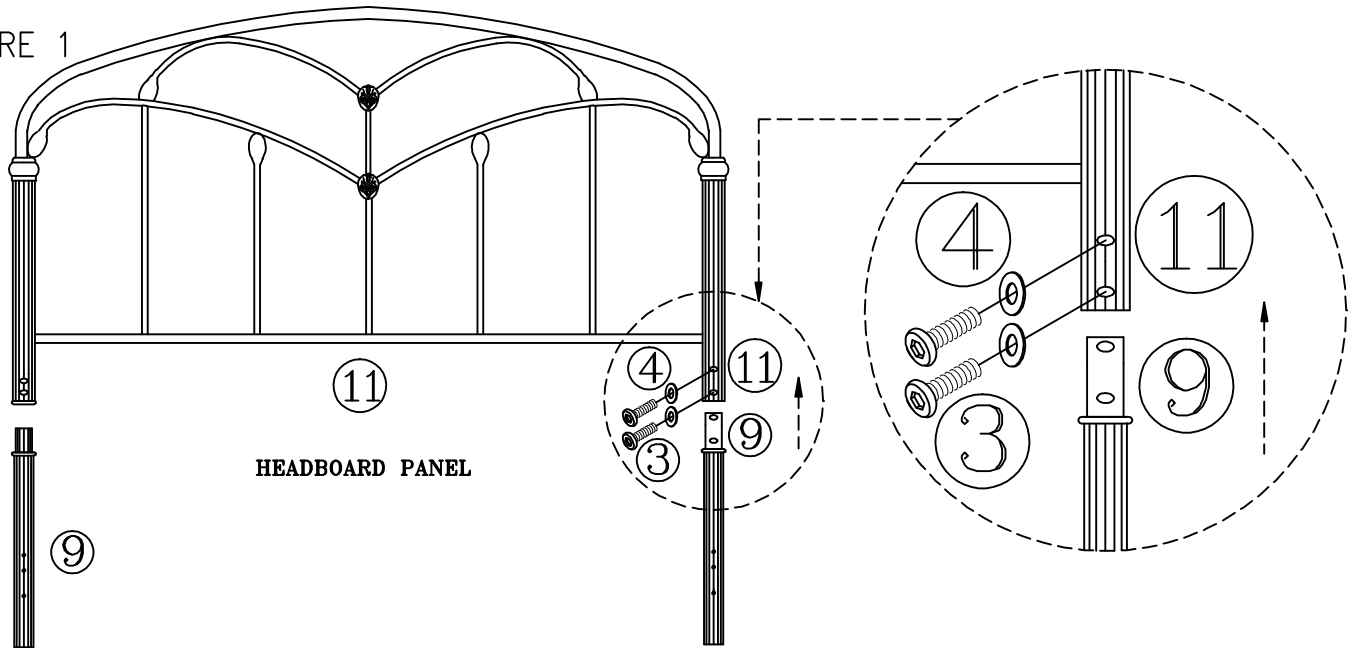

FIGURE 2

## Step 1

- Align top reduction of leg extension (9) with bottom of headboard panel (11) posts . (SEE FIGURE 1)
- Now carefully insert leg extension (9) into bottom of headboard panel (11) post.
- Secure leg extension with screw (3) and flat metal washer (4). using allen wrench (7).

## Step 2

- Place headboard and frame in desired location in room.
- Place 2 screws (1) through holes located in leg (9) (SEE FIGURE 2)
- Align bed frame bracket over screws.
- Place a flat metal washer (4), lock washer (5) and hex nut (6) over on each screw. Hand tighten. DO NOT TIGHTEN screws all the way. (SEE FIGURE 2)
- Repeat on other side of headboard.
- Tighten all screws securely using the Allen wrench (7) and open wrench (8).