

## Parts and Damage Replacement Procedure

1. Please inspect your purchase immediately.
2. This procedure covers product purchased from an authorized Roundhill Reseller and was received in its originally sealed carton.
3. If you find a part missing or damaged, you have a 30-day window in which to order a replacement part from the date on your purchase receipt.
4. You have 3 ways to do this. You will need a copy of your purchase receipt.
  - a. By Fax: Fax the parts order form below and along with your receipt.
  - b. By Email: Email the order form and along with your receipt.
  - c. By Mail: Fill out the parts order form below and along with a copy of your receipt send it to our furniture parts department.
5. Once this order is sent in, you will be notified if the part(s) you are requesting can or cannot be shipped within 7-10 business days.

**A COPY OF YOUR PURCHASE RECEIPT OR INVOICE MUST BE ATTACHED TO THIS ORDER FORM.  
NO ORDERS WILL BE PROCESSED WITHOUT PROOF OF PURCHASE.**

NAME: \_\_\_\_\_

ADDRESS: \_\_\_\_\_ (No Post Office Boxes)

CITY: \_\_\_\_\_ STATE: \_\_\_\_\_ ZIP: \_\_\_\_\_

PHONE: \_\_\_\_\_ FAX: \_\_\_\_\_

EMAIL: \_\_\_\_\_

**REASON FOR REPLACEMENT/PLEASE CHECK APPROPRIATE BOX.**

- ( ) Damaged /scratched, cracked, broken, crushed, etc.
- ( ) Mechanical malfunction/ drawer glides, swivel mechanisms, lid stays, etc.
- ( ) Missing pieces
- ( ) Unfinished surface
- ( ) Wrong color
- ( ) Other











IF MORE THAN ONE MODEL NUMBER IS LISTED ABOVE, PLEASE SPECIFY THE EXACT MODEL NUMBER OF YOUR ITEM IN THE SPACE PROVIDED BELOW.

Model Number	Part Letter Code	Quantity

# ASSEMBLY INSTRUCTIONS

## DESCRIPTION : DRESSER

Thank you for purchasing this quality product. Be sure to check all packing material carefully for small Hardware which may have some loose inside the carton during shipment. Identify and count all Hardware. Identify and count all Hardware and compare with the Hardware List Below.

PARTS LIST				HARDWARE LIST				
No.	Description	Sketch	Q'ty	No.	Description	Sketch	Size	Q'ty
A	Dresser		1pc	1	Allen Bolt		Ø5/16"x38mm	8pcs
B	Front Bun Foot		2pcs	2	Spring Washer		Ø5/16"	8pcs
C	Right Back Bun Foot		1pc	3	Flat Washer		Ø5/16"x19mm	8pcs
D	Left Back Bun Foot		1pc	4	Allen Key		4mm	1pc
E	Support Leg		1pc	5	Tipping Restraint			1pc

### Step 1:

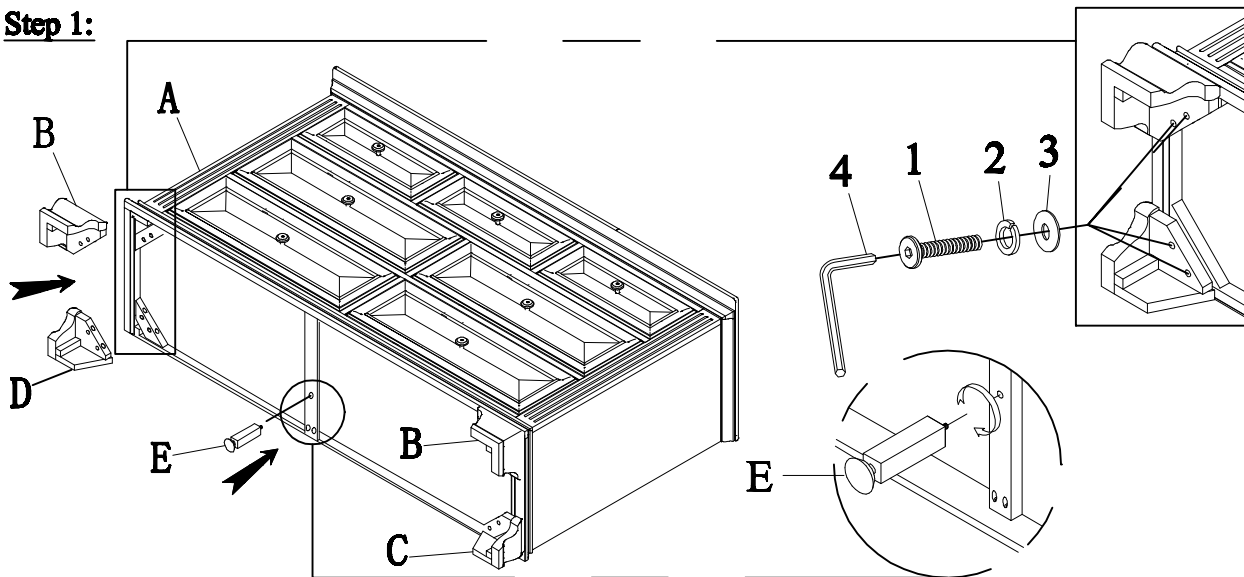

# ASSEMBLY INSTRUCTIONS

## DESCRIPTION : DRESSER

Thank you for purchasing this quality product. Be sure to check all packing material carefully for small Hardware which may have some loose inside the carton during shipment. Identify and count all Hardware. Identify and count all Hardware and compare with the Hardware List Below.

### Step 2:

