



## Bookshelf

### WARNING

Small parts and sharp points may be present prior to assembly.

### CARE INSTRUCTIONS

To clean your product, use mild soap and water on a damp cloth. Do not use window cleaners or cleaning abrasives as they will scratch the surface and could damage the protective coating.

### CUSTOMER SERVICE



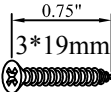
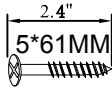
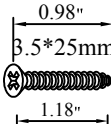
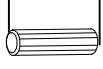

For questions regarding this product, or to receive replacement or missing parts, please contact customer service based on your location. Please have ready the model number and part number(s) located in this assembly instruction sheet when you contact us.

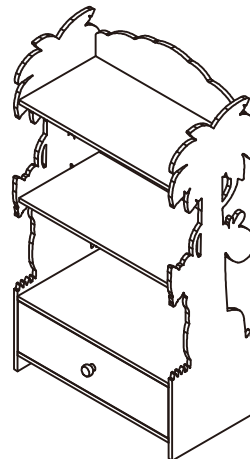



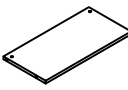
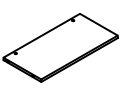

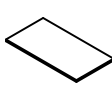
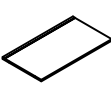
### HARDWARES:

- ①  1PCS
- ②  18PCS
- ③  12PCS
- ④  2PCS

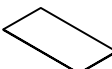

### PRODUCT PARTS:

A	B	C	D	E	F	G	H
							
2PCS	1PC	1PC	1PC	1PC	1PC	1PC	1PC

I	J	K	L	M	N
					
1PC	1PC	2PCS	1PC	1PC	1PC

### STEP 1

③  2PCS

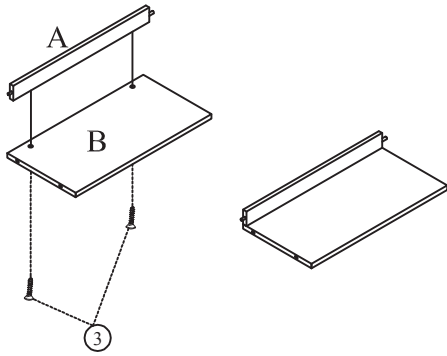

### STEP 2

③  2PCS

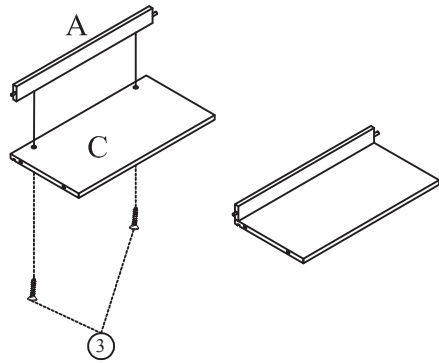

### STEP 3

②  9PCS

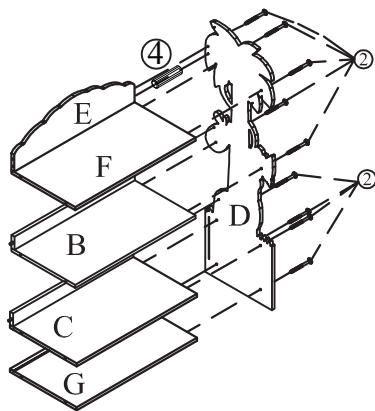

### STEP 4

②  9PCS

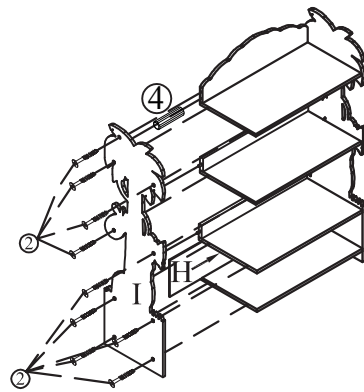

## STEP 5

①  1 PCS

③  8 PCS

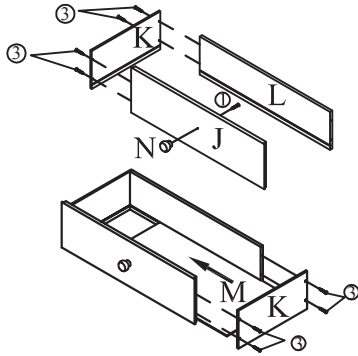

## STEP 6

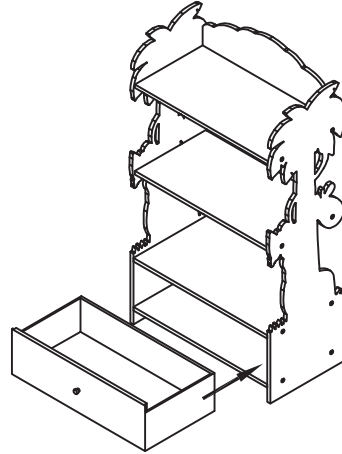

## STEP 7

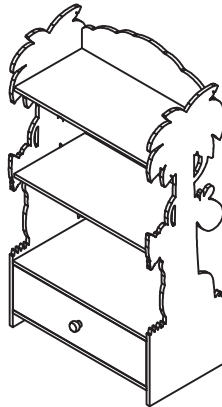

(Finished Product)

MADE IN CHINA