

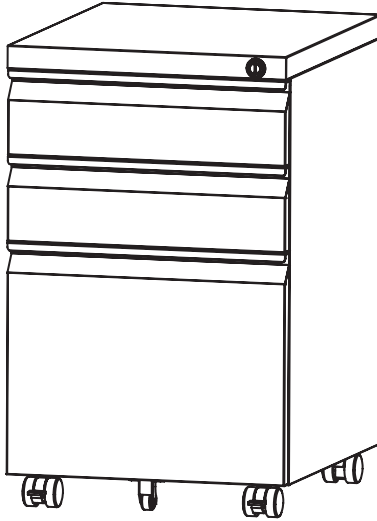

DEVAISE
WWW.DEVAISE.COM



AHDG025

Steel 3 Drawer Mobile Cabinet

V3.0



IMPORTANT INFORMATION

READ CAREFULLY.

KEEP THIS INFORMATION FOR FURTHER REFERENCE.

GENERAL GUIDELINES

- Please read the following instruction carefully and use the product accordingly.
- Please keep this manual and hand it over when you transfer the product.
- This summary may not include every detail of all variations and considered steps. Please **contact us** when further information and help are needed.

NOTES

- Please follow the assembly instructions precisely and only use the product as intended.
- If an odor is present when first opening the package, please leave the unwrapped product in a shaded and ventilated area for a few days to air out.
- Prior to assembly, please check the product for defects or missing accessories. If any defects are found or accessories are missing, do not use product as damage or injury may occur;
Please **contact us** for assistance and replacement.
- It is suggested you regularly check the products bolts and connections to ensure safe use.
- Assemble the item on a soft flat and clean surface to avoid scratches and damage.
- It is recommended that two people assemble this product.

WARNINGS

- During assembly, keep parts and packaging materials away from children and pets as there could cause injury and are a potential choking hazard.
- Avoid sharp objects or corrosive chemicals to prevent damage to the product.
- Please open the item slowly and cautiously to avoid pinching your hands by metal joints, especially children.







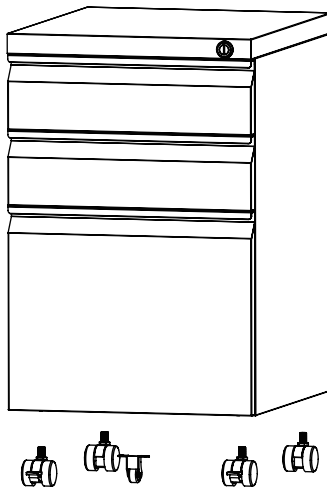



- If you have any further questions, please feel free to contact us by email or official website: devaise-cs@devaise.com
We will reply ASAP.
- Before installation, please make sure you have all the hardware, the serial numbers are properly labeled corresponding to the list, and the quantity is correct.
- Enjoy your new purchase!





EXPLODED DRAWING

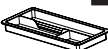

PARTS



 A X2	 B X2	 C X1	 D X4	
 E X2	 F X1	 G X1	 H X1	 I X1

1

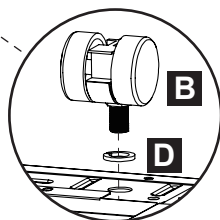
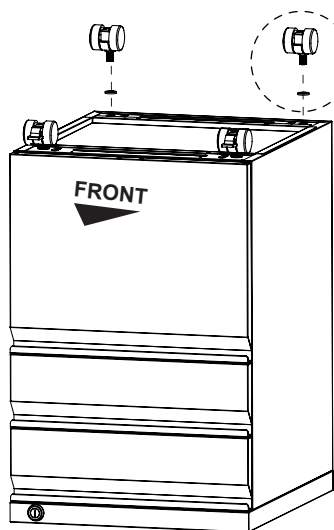
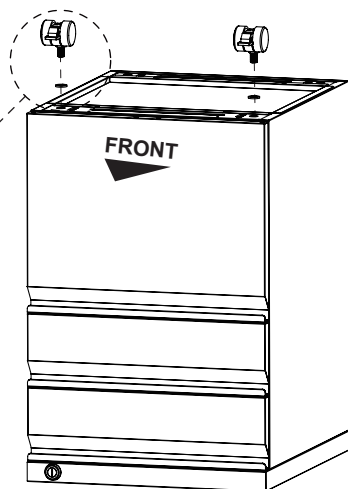
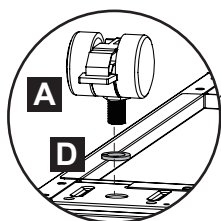
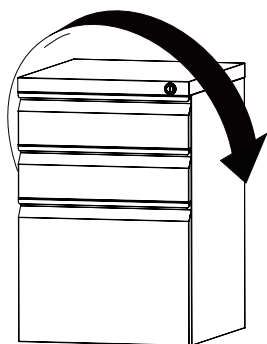
 A X2	 B X2
 D X4	 G X1



2

	C X1		E X2
			H X1

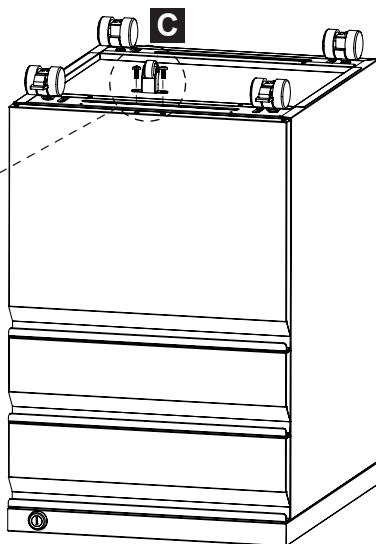
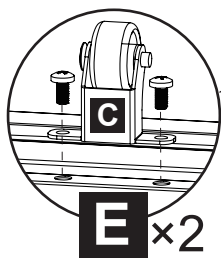

3

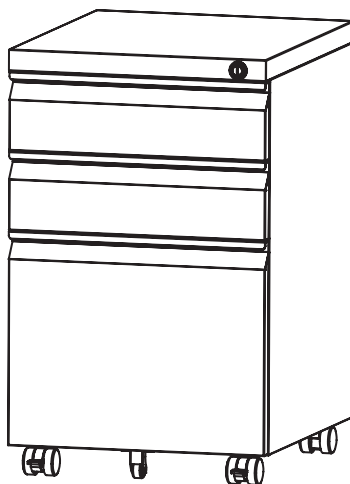
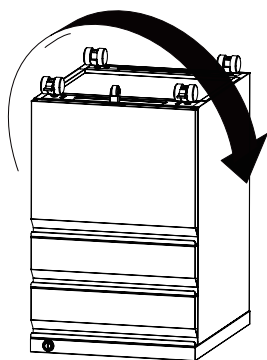

4

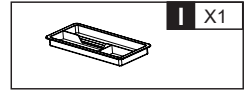
**REMARK**

Remove or adjust the stationary tray, please follow the below method.

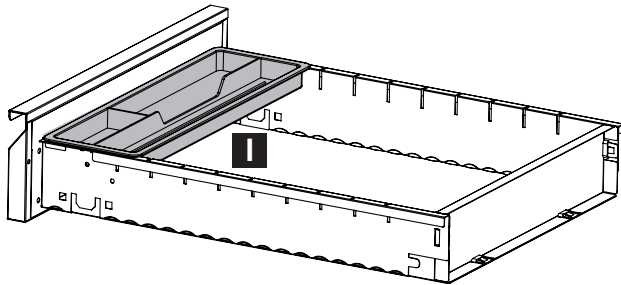
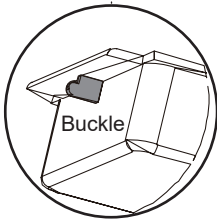
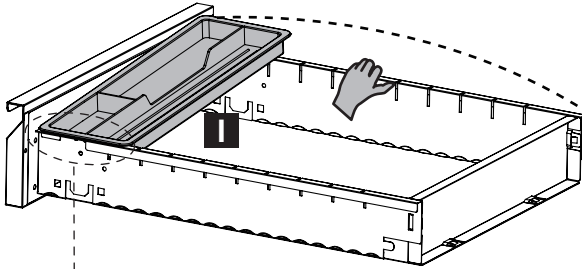

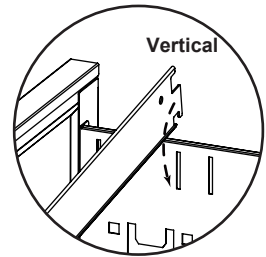
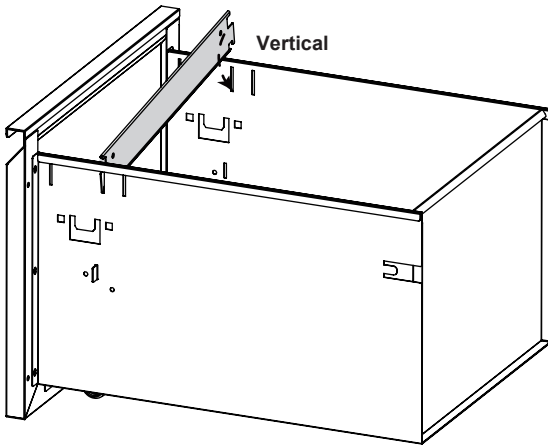
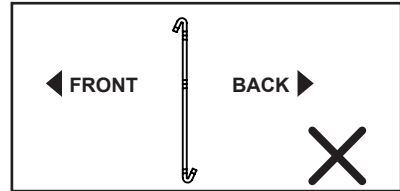
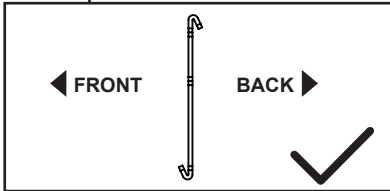
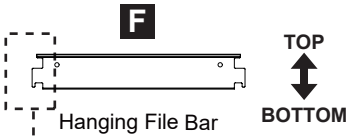
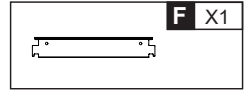

REMARK

Install or adjust the hanging file bar, please follow the below method.

6

One filing drawer support A4, legal, letter size file folders

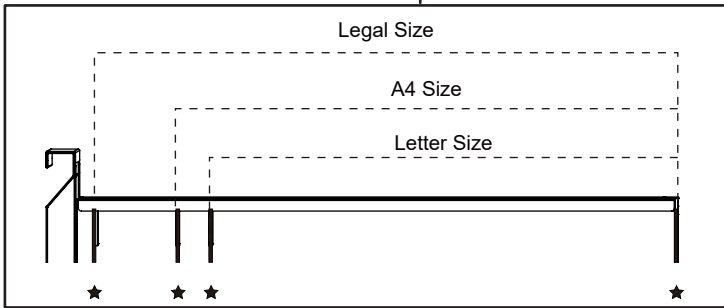
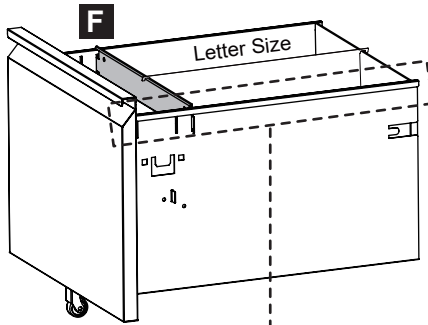

Adjust the position of Part **F** for letter, A4, legal size files.

The hanging method for Letter size files without hanging bar

