

Installation Guide

SMART TOILET



Prior to Unpacking



- Overall package weighs about 100 pounds! Two adults are required to carefully unpack the product to avoid personal injuries or accidental damage to the item.
- Each item is carefully packed in customized foam. However, violent handling and shipping might crack the item. Observe potential damage while unpacking.
- The seat cover might not be hinged firmly with the toilet base. **DO NOT** lift the toilet by grabbing the separate seat.



TEAM LIFT



FRAGILE

Prior to Installation



- Inspect the toilet to ensure no damages during transit.
- Observe all plumbing and building codes in accordance with your state and local requirements.
- All dimensions are nominal. Actual size of item received might vary by up to 1/8 inch. Make sure to measure your toilet before installation.
- The step-by-step guide in the installation instructions is for general reference only. Should there be any discrepancies, Eridanus cannot be held liable. It is recommended that all Eridanus products be installed by a licensed professional.
- Read installation and maintenance instructions and user manual thoroughly before installing. Be sure to use proper tools and always wear proper personal safety equipment.
- Two adults are required to handle and install the toilet to avoid personal injuries or accidental damage to the item.
- Diagrams are for general display and do not represent a specific model.
- Make sure water pressure meets the minimum requirement for your model.
- This appliance must be grounded. Connect only to a circuit protected by a Ground-Fault Circuit-Interrupter(GFCI) or Residual Current Device(RCD).

- Confirm that the item received will fit in the intended location and that plumbing fixtures are located where legally required before installation begins.

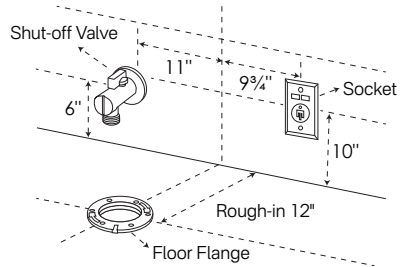

Checklist

• What's in the box

- a. Smart Toilet
- b. Shut-off Valve (1/2" NPT x 3/4" G)
- c. Toilet Inlet Adapter (3/4" G x 7/8")
- d. Wax Ring Gasket
- e. Flange
- f. Mounting Bolts
- g. Battery Box
- h. User Manual
- i. Installation Guide
- j. Remote Control
- k. Supply Line (3/4" G x 3/4" G)
- l. Footprint Template

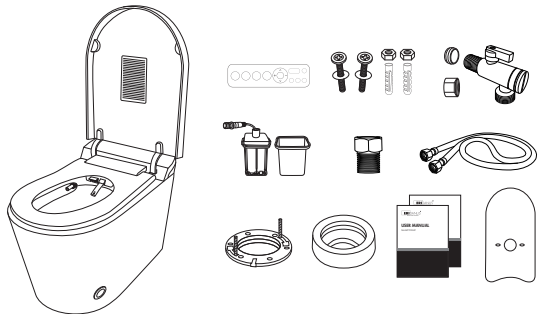

• Extra Parts/Tools Required

- i. Safety Glass
- ii. Tape Measure
- iii. Screwdriver
- iv. Adjustable Wrench
- v. Putty Scraper
- vi. Pencil/Marker
- vii. Caulk
- viii. AAA Battery x2
- ix. AA Battery x4

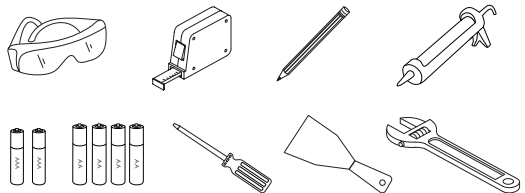

- x. Paper Towels
- xi. Disposable Gloves
- xii. Bucket
- xiii. Level
- xiv. Drill
- xv. Soft Cloth/Tarp

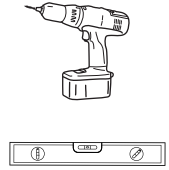
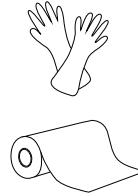

NOTE Other tools might be required during installation.

Installation

Important

- Before installation, please be sure to confirm the water supply connection options. For details, please refer to page 6.

Install Closet Flange & Bolts

- Inspect existing closet flange. Replace it if necessary.



REMINDER When replacing the flange, always remember to lock the nuts into position to prevent the toilet from shifting over time and damaging the wax seal.

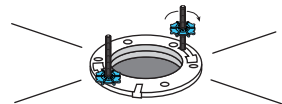
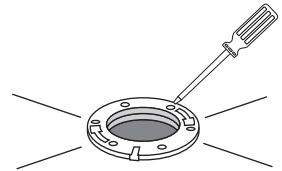

Remove Bidet Assembly

- This step is to create space to see the mounting bolts through the base holes when placing the bowl on the flange, and to reach in for installing the washers and nuts to secure the toilet.
- Lift the bidet from the back. If space allows, slide the bidet aside without disconnecting the hose or wiring. Otherwise, disconnect them and then carefully remove the bidet.

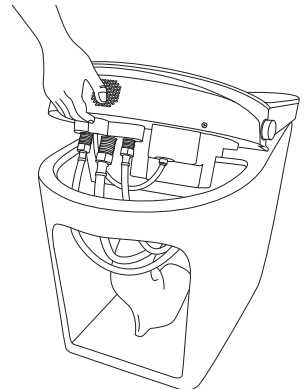

Install Wax Ring

- With assistance, carefully turn the toilet on its side.
- Press the wax ring firmly onto the toilet's discharge outlet, ensuring it is centered and evenly seated.
- * Before setting the toilet, avoid touching or compressing the wax ring to prevent deformation.

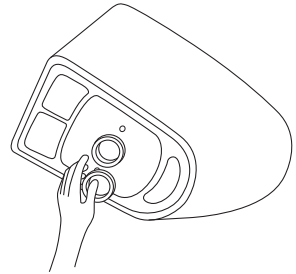

REMINDER Place a soft cloth or cardboard on the floor when laying the toilet on its side to protect its surface.

Install Toilet Bowl

- Gently lower the toilet bowl onto the floor flange, ensuring the closet bolts align with and pass through the pre-drilled holes.
- Position the toilet squarely against the wall, then firmly press down on the wax ring and flange to establish a waterproof seal. Secure the toilet by alternately tightening the washers and nuts until it is firmly anchored to the floor.



REMINDER Avoid over-tightening as it could potentially cause the ceramics to crack.

- Apply a smooth layer of sealant around the base. Remove any excess sealant.

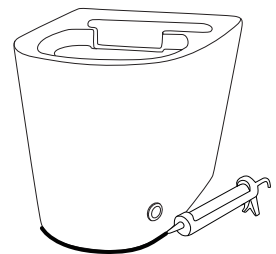
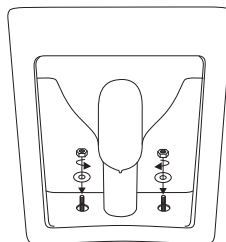
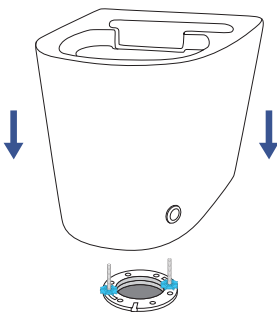

Reinstall Bidet Assembly

- Position the bidet on the toilet bowl and reconnect the hose and wire.
- Align the grooves on the bottom of the bidet with the clips on the toilet.
- Press down firmly on both sides of the bidet until it is securely locked into place.

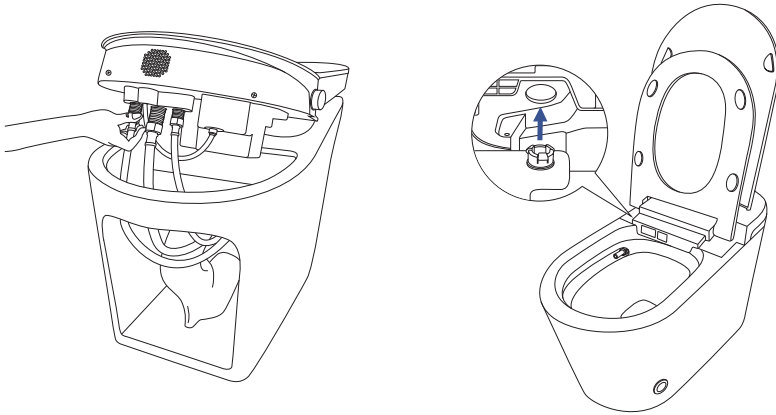

Install Shut-off Valve and Supply Line



Overview:

To accommodate a variety of residential plumbing systems, we provide three installation options for connecting the water supply to the smart toilet. Follow the instructions below to ensure a proper and reliable connection.

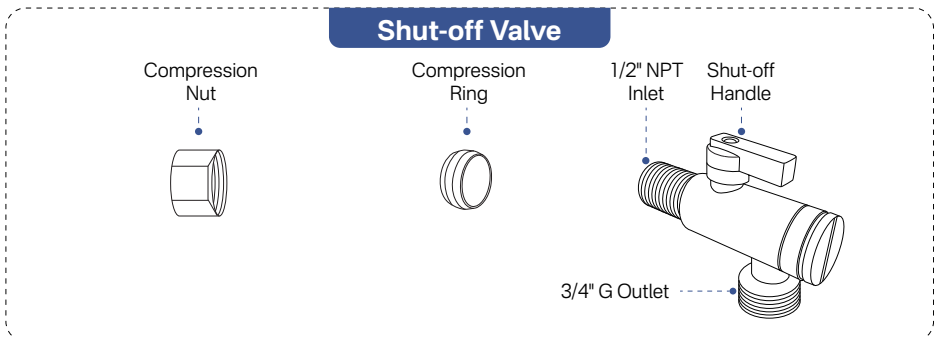

Option 1: Using the Provided Shut-off Valve and Supply Line (Recommended)

 **NOTE** This installation method is commonly used with wall water supply pipes made of copper.

- Remove the existing shut-off valve from the wall.
- Install the provided valve onto the water supply pipe. Turn the handle to check water flow (the first turn may require extra force).
- Connect the supplied supply line to the shut-off valve.
- Test water pressure and adjust the valve as needed to ensure proper flushing.

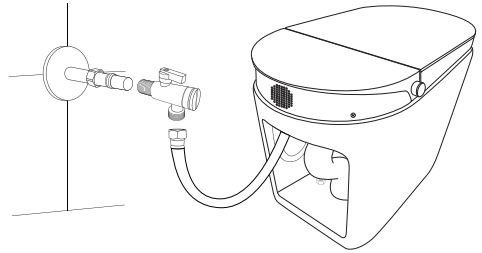

 Please ensure all connections are properly sealed during installation, and check carefully for any leaks after installation.

Option 2: Using Your Existing Shut-off Valve and Supply Line (Alternative)

- Keep the existing shut-off valve on the wall. Remove the provided supply line from the toilet.
- Attach the supplied inlet adapter to the toilet's rear water inlet.
- Connect your own supply line between the shut-off valve and the toilet water inlet. Then check for leaks.

 **NOTE** The provided adapter is 3/4" G female × 7/8" male. Make sure the toilet-side connection of your supply line is 7/8" and the valve-side connection matches your existing shut-off valve.

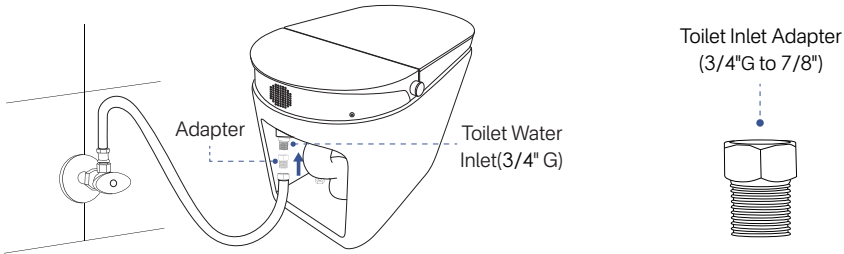

Option 3: Using Your Existing Shut-off Valve and the Provided Supply Line (Alternative)



NOTE To ensure a proper fit, an additional shut-off valve (sold separately) may be required when using your own valve with the provided supply line. If needed, please contact us at the email below.

- Keep the existing shut-off valve on the wall, make sure it has a 3/8" outlet. Install the additional shut-off valve (3/8" x 3/4" G) onto your existing shut-off valve.
- Connect the provided supply line to the shut-off valve. Then check for leaks.

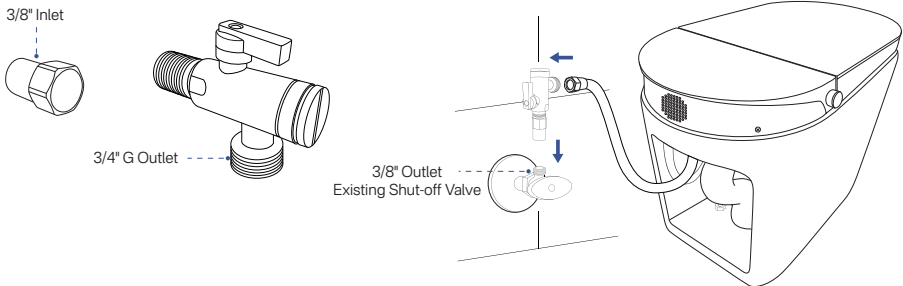

Test Toilet Functions

- Connect the toilet to a grounded power outlet.
- Perform a test flush and check for leaks around the water supply lines and the floor flange.
- Refer to the User Manual to confirm that all smart toilet functions are operating correctly.

Contact Information

✉ Email

support@eridanus.net

If you encounter any issues with installation, operation, or the product, please contact our after-sales support team through this email. We will respond within 1 business day.

Installation Guide