

ASSEMBLY INSTRUCTIONS

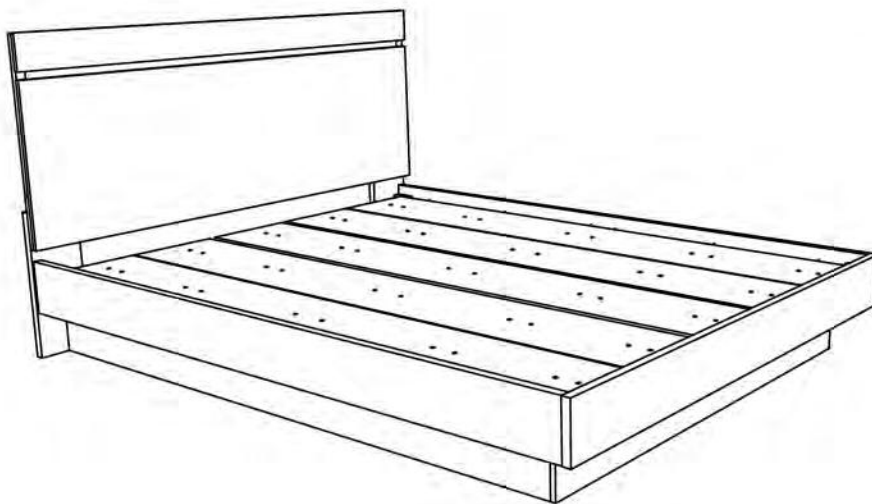

TOOLS REQUIRED



Allen Wrench

(Included)



Phillips
Screwdriver

(Not Included)



**3 - People
Recommended**

ASSEMBLY RATING



EASY —————> DIFFICULT

The Assembly Rating is a 5-point system showing the level of effort needed to assemble a specific product.



CHECK BEFORE STARTING

Are you missing anything?

Double-check all parts, hardware and accessories listed are all accounted for.

Check out our Quick Tips!

We recommend reviewing the pre-assembly handouts. Even experts need a refresher now and then!

Should we send any replacements?

Are there any irregularities or flaws in the parts? We can send replacements!

Prep Time!

Please review the assembly instructions and all diagrams prior to assembling.

PRE ASSEMBLY INTRODUCTION

We understand building ready-to-assemble furniture can be a challenging experience for some. To help avoid confusion, we have provided some helpful tips that may speed up the process.



Teamwork

ALWAYS have at least two people to help with transporting and assembling the product to avoid potential injury and/or damage.



Suitable Location

Assembling near the area of the intended location is highly recommended.



Sufficient Space

Make sure you have enough space to move around during the assembly.



Avoid Scratches

Use cardboard, blankets or a carpeted area while assembling furniture to prevent to prevent scratches and damages.



Flat Surface

Make sure the furniture rests on a flat and level surface with each leg evenly touching the floor.

ASSEMBLY AND CARE ADVICE



FAILURE TO FOLLOW THE GUIDELINES BELOW MAY RESULT IN INJURY AND/OR PROPERTY DAMAGE.



Position each part correctly and insert screws or bolts into their respective holes.



Turn clockwise to tighten and only tighten when step is completed or when instructed to do so.



Use the appropriate hand tools or power tools for assembly. Select steps, such as tightening screws and/or bolts, may require hand tools to avoid causing damage during assembly.



Save the instructions and store any supplied tools for later maintenance.



After two weeks, check and tighten any loose hardware and repeat again every six months thereafter.

IT IS THE USER'S RESPONSIBILITY TO MAINTAIN THE FURNITURE. THE HARDWARE MAY LOOSEN OVER TIME AND MAY CAUSE THE FURNITURE TO BE WOBBLY AND UNABLE TO SUPPORT ITS INTENDED WEIGHT CAPACITY. THIS MAY LEAD TO COLLAPSE AND MAY CAUSE SERIOUS INJURY.

QUEEN SIZE BED



- Please keep instructions for future reference.
- Check the quantity and irregularity of parts and hardware before you start.

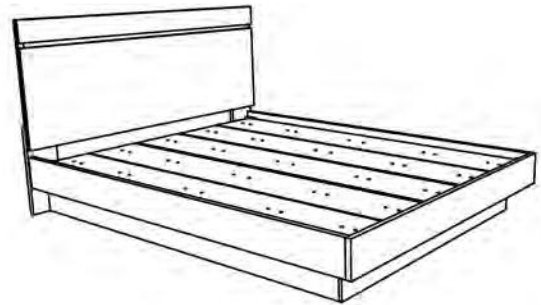

PARTS

#1 1pc



Headboard

#2 2pcs



Headboard Leg
(L&R)

#3 1pc



Footboard

#4 2pcs



Side Rail

#5 2pcs



Platform Rail

#6 2pcs



Bed Slat with Marking
-1545 x 45 x 18mm

#7 3pcs



Bed Slat without Marking
-1545 x 45 x 18mm

#8 1pc



Platform Rail
Support
-1390 x 45 x 18mm

#9 5pcs



Bed Slat Support
-225 x 30 x 30mm

#10 5pcs



Concealed Panel
-2040 x 295 x 9mm

HARDWARE

HARDWARE INSIDE HEADBOARD

#A 1pc



Allen Key M4

#B 4pcs

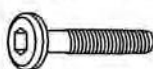

Bolt 1/4" x 1-3/8"

#C 4pcs



Lock washer

#D 4pcs



Flat washer

#E 8pcs



CSK m4 x 32mm

#F 1pc



Adaptor

HARDWARE INSIDE SIDE RAIL

#G 12pcs

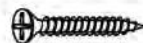

CSK m4 x 32mm

#H 5pcs



Bolt 1/4" x 2"

#I 25pcs

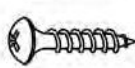

Pan Head Screw
m3.5 x 20mm

#J 1pc











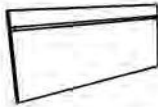











Allen Key M4

#K 1pc



Allen Key M5

Carton	Designation	Part		Hardware
	Queen Size Bed HB	#1		 #A x 1pc  #B x 4pcs  #C x 4pcs
#2		 X 2	 #D x 4pcs  #E x 8pcs  #F x 1pc	
	Queen Size Bed FB	#3		
	Queen Size Bed Rails	#4	 X 2	 #G x 12pcs  #H x 5pcs
#5		 X 2	 #I x 25pcs  #J x 1pc	
#6		 X 2	 #K x 1pc	
#7		 X 3		
#8				
#9		 X 5		
#10		 X 5		

ASSEMBLY INSTRUCTIONS

1

Align Headboard Leg(#2) to Headboard(#1), then secure by using JCBC (#B), Spring Washer (#C) and Flat Washer (#D) tighten with Allen Key(#A). Also scure Headboard with CSK screw(#E) and tighten with Scew Driver(NOT PROVIDED)

- Part #1 x1pc
- Part #2 x2pcs
- Hardware #B x4pcs
- Hardware #C x4pcs
- Hardware #D x4pcs
- Hardware #E x8pcs

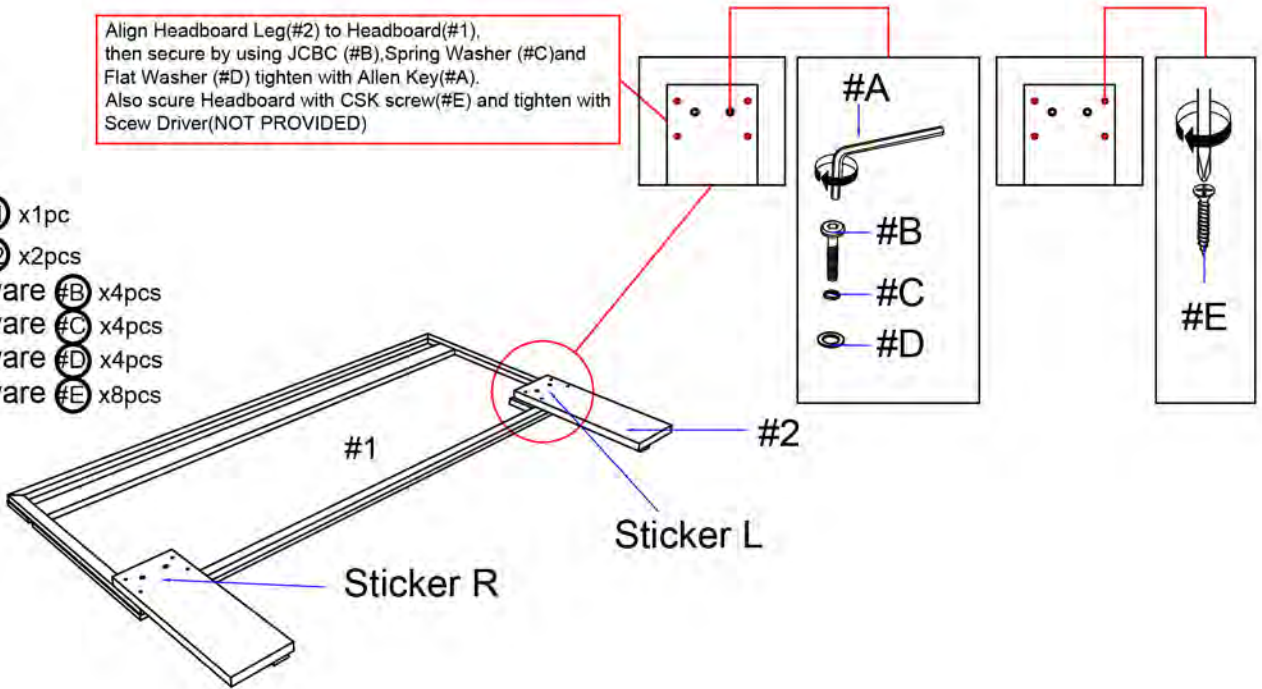

2

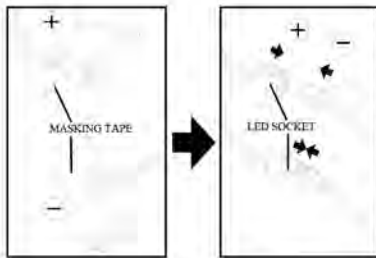

CAUTION !!!
PLEASE
CONNECT THE
LED TERMINAL
SOCKET
AFTER FIT IN THE
HOOK PART
AS SHOWN.

PLEASE REMOVE MASKING TAPE
BEFORE CONNECT

Align side rails (#4) & (#5) to the bolts of the headboard Leg (#2) and footboard (#3). Fully tighten the bolts.

- Part #3 x1pc
- Part #4 x2pcs
- Part #5 x2pcs
- Part #8 x1pc
- Hardware #G x2pcs

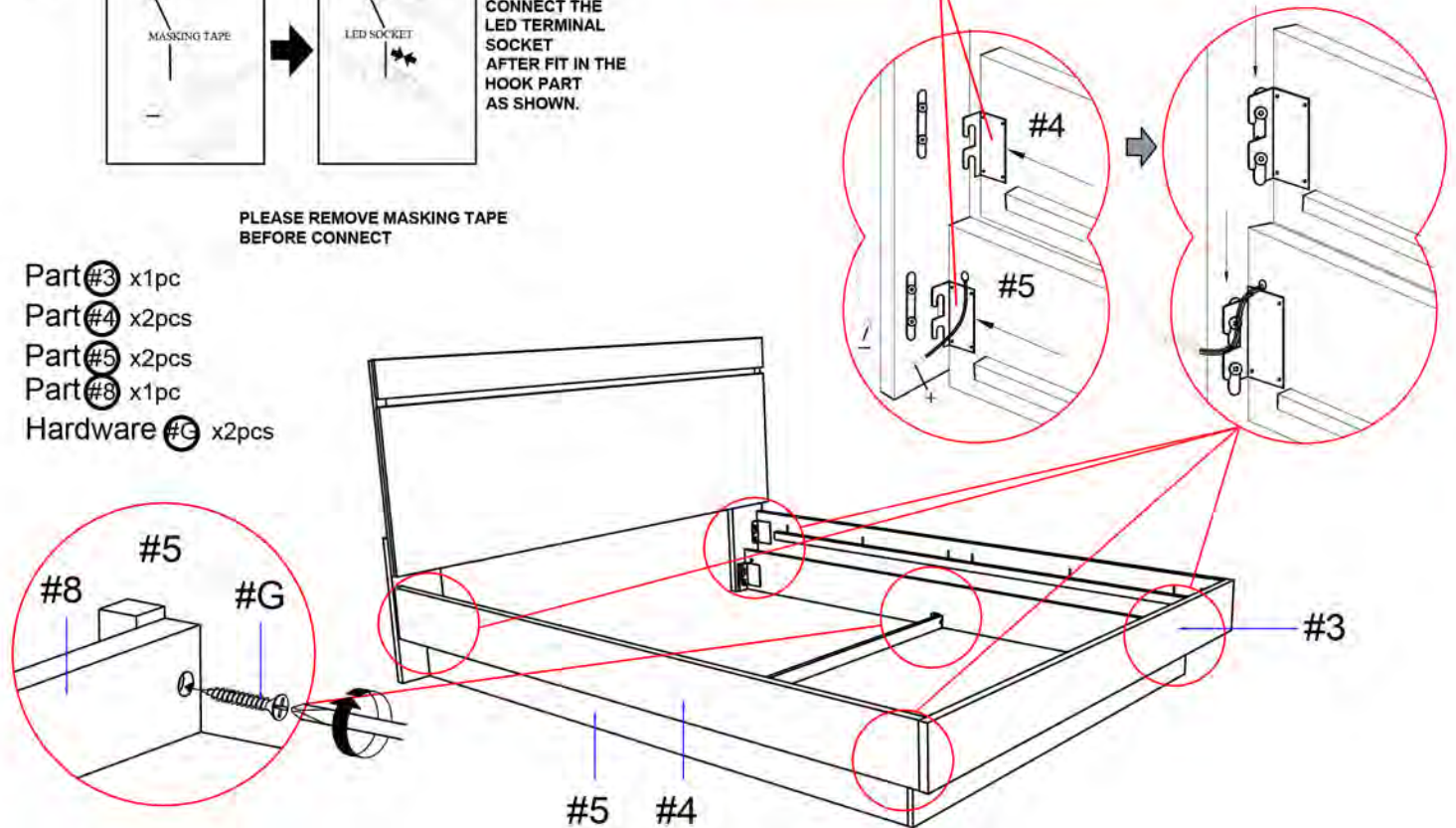

ASSEMBLY INSTRUCTIONS

3

- Part #6 x2pcs
- Part #7 x3pcs
- Part #9 x5pcs
- Hardware #H x5pcs

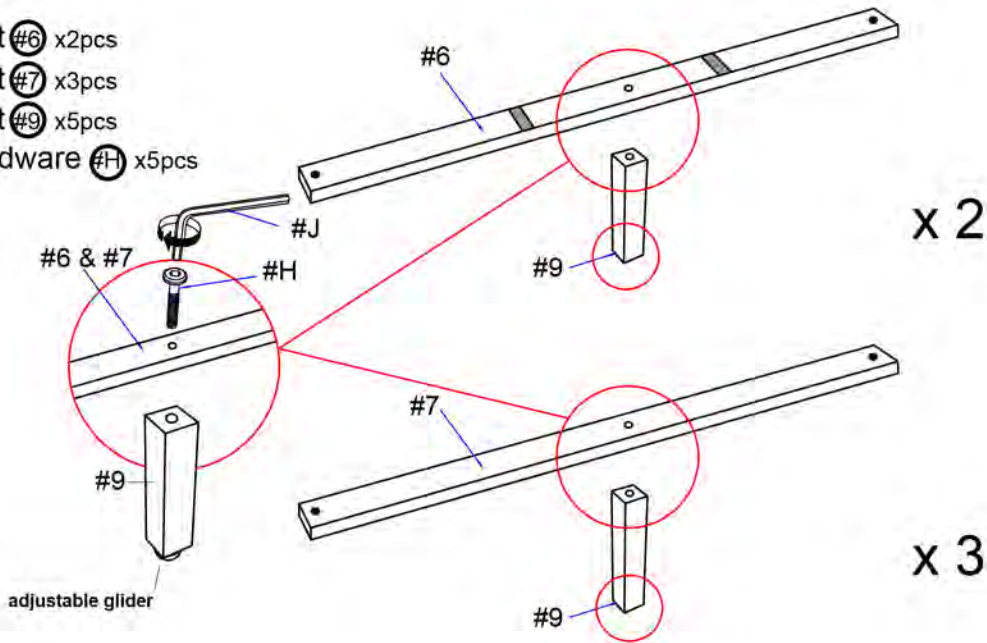

4

- Hardware #G x10pcs

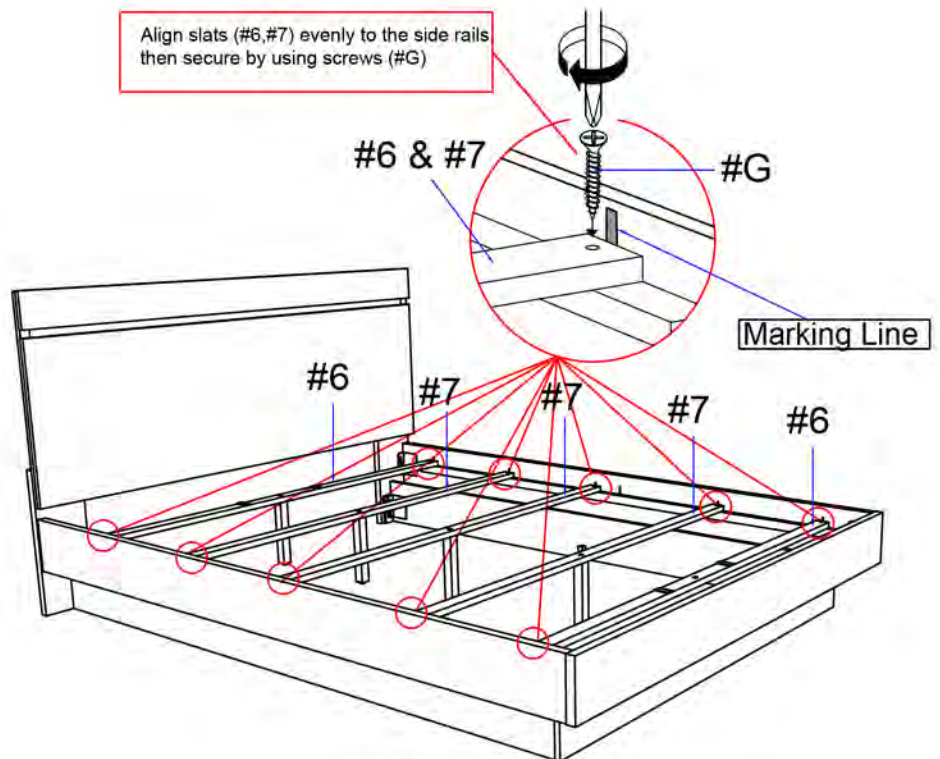

ASSEMBLY INSTRUCTIONS

5

Part #10 x5pcs
 Hardware #F x1pc
 Hardware #I x25pcs

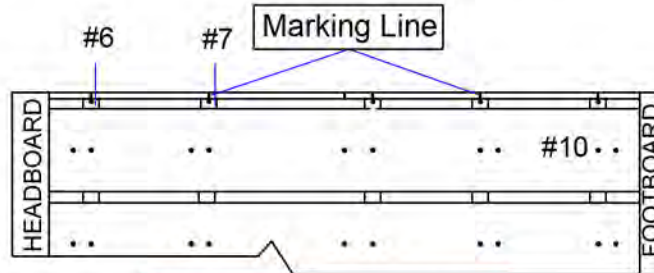

This is how the concealed panel (#10) look like on the bed from a high view.

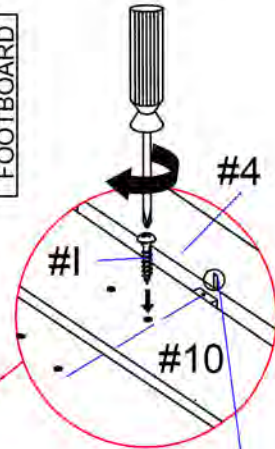

Attach adaptor (#C).

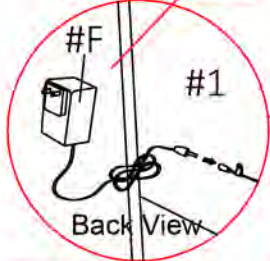

Back View

To Active

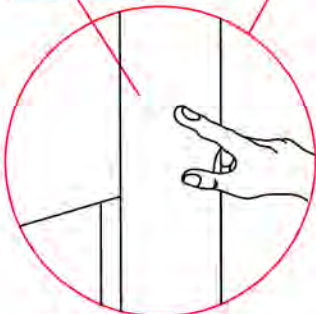

Switch on Button

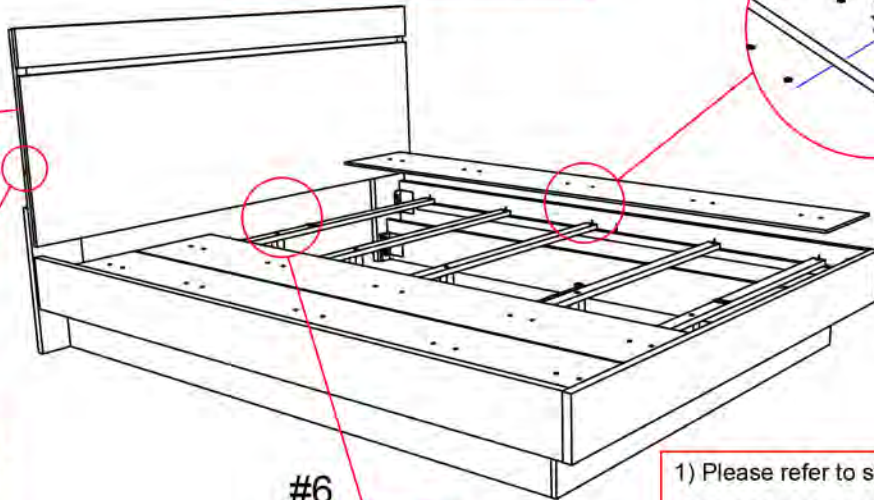

Marking Line

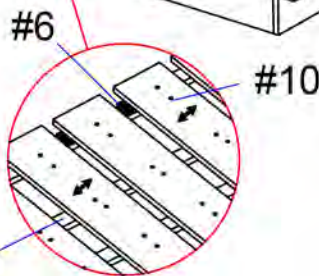

- 1) Please refer to steps (#5) on how to align and place concealed panels(#10) correctly.
- 2) Secure concealed panels (#10) to bed slats by using screws (#I).

ASSEMBLY COMPLETED



Please ensure the furniture rests on an even and flat surface. If the product wobbles or feels loose, double-check all bolts and/or screws are properly tightened and secured.

Keep this handy!

Please retain this instruction manual and any order-related information for future reference.

Lift, don't drag!

To avoid damage to product please always LIFT the product when transporting of adjusting the placement.

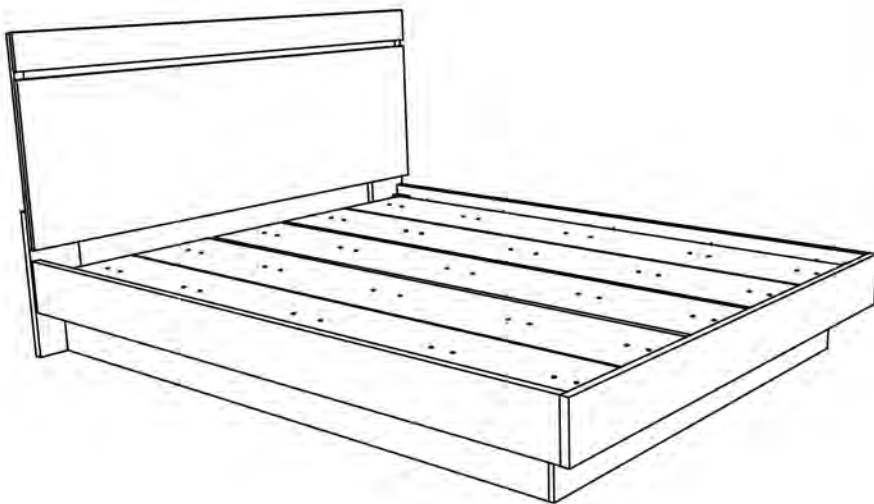

ASSEMBLY INSTRUCTIONS

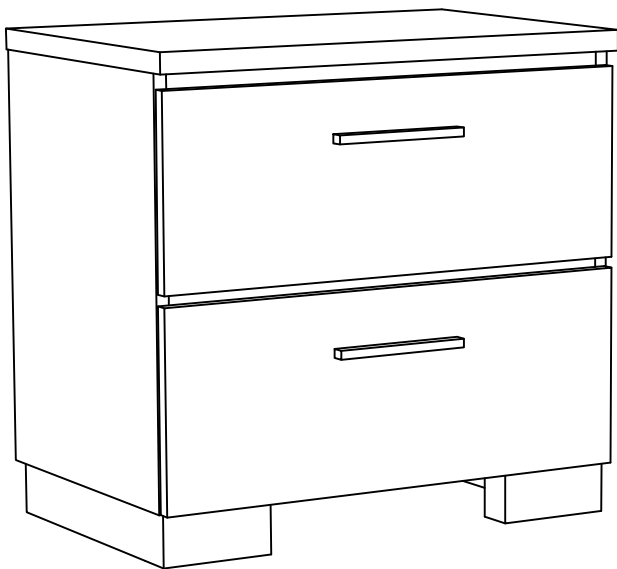

TOOLS REQUIRED



**Philips
Screwdriver**

(Not Included)



**2 - People
Recommended**

ASSEMBLY RATING



EASY —————> DIFFICULT

The Assembly Rating is a 5-point system showing the level of effort needed to assemble a specific product.



CHECK BEFORE STARTING

Are you missing anything?

Double-check all parts, hardware and accessories listed on Page 6 are accounted for.

Check out our Quick Tips!

We recommend reviewing the pre-assembly handouts. Even experts need a refresher now and then!

Should we send any replacements?

Are there any irregularities or flaws in the parts? We can send replacements!

Prep Time!

Please review the assembly instructions and all diagrams prior to assembling. Arrange parts as recommended on Page 7 and group identical hardware together to make assembling easier.

PRE ASSEMBLY INTRODUCTION

We understand building ready-to-assemble furniture can be a challenging experience for some. To help avoid confusion, we have provided some helpful tips that may speed up the process.

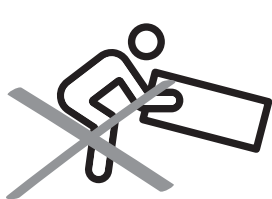

Teamwork

ALWAYS have at least two people to help with transporting and assembling the product to avoid potential injury and/or damage.

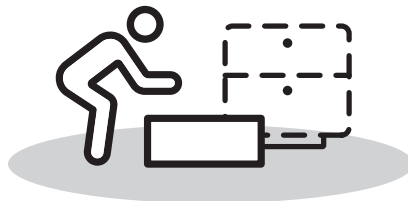
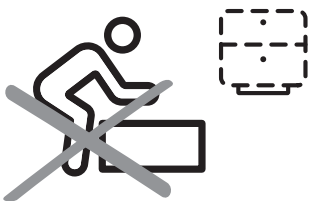

Suitable Location

Assembling near the area of the intended location is highly recommended.



Sufficient Space

Make sure you have enough space to move around during the assembly.

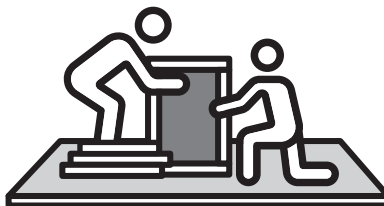

Avoid Scratches

Use cardboard, blankets or a carpeted area while assembling furniture to prevent scratches.

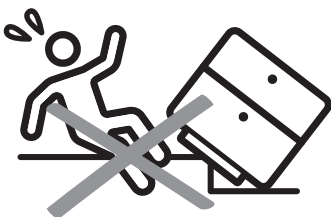

Flat Surface

Make sure the furniture rests on a flat and level surface with each leg evenly touching the floor.

ASSEMBLY AND CARE ADVICE



FAILURE TO FOLLOW THE GUIDELINES BELOW MAY RESULT IN INJURY AND/OR PROPERTY DAMAGE.



Position each part correctly and insert screws or bolts into their respective holes.

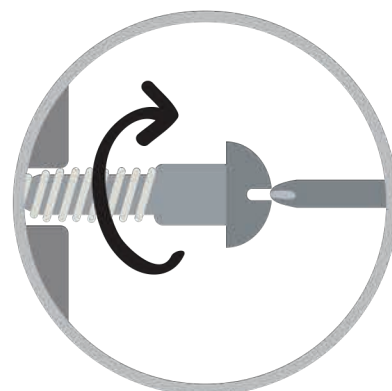

Turn clockwise to tighten and only tighten when step is completed or when instructed to do so.



Use the appropriate hand tools or power tools for assembly. Select steps, such as tightening screws and/or bolts, may require hand tools to avoid causing damage during assembly.



Save the instructions and store any supplied tools for later maintenance.

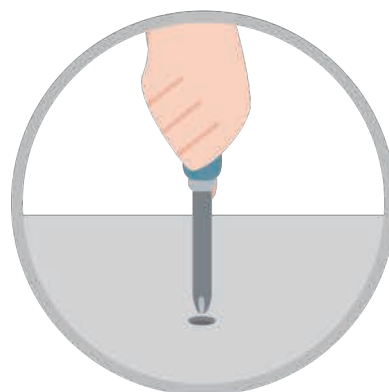

After two weeks, check and tighten any loose hardware and repeat again every six months thereafter.

IT IS THE USER'S RESPONSIBILITY TO MAINTAIN THE FURNITURE. THE HARDWARE MAY LOOSEN OVER TIME AND MAY CAUSE THE FURNITURE TO BE WOBBLY AND UNABLE TO SUPPORT ITS INTENDED WEIGHT CAPACITY. THIS MAY LEAD TO COLLAPSE AND MAY CAUSE SERIOUS INJURY.

NIGHTSTAND



- Please keep instructions for future reference.
- Check the quantity and irregularity of parts and hardware before you start.

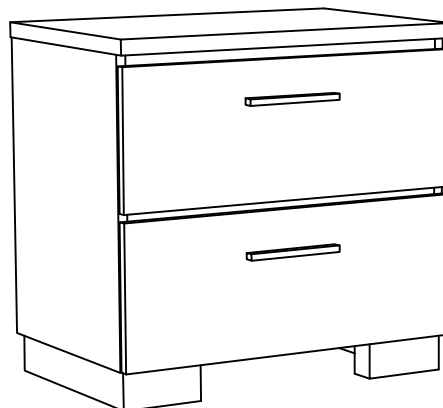

PARTS

#1 1pc



Nightstand

HARDWARE

#A 2pcs



Csk Screw
m3 x 20mm

#B 1pc



USB Port

ASSEMBLY INSTRUCTIONS

Attach USB ports to the desired location of the nightstand (#1)

1

Part #1 x1pc

Hardware #A x2pcs

Hardware #B x1pc

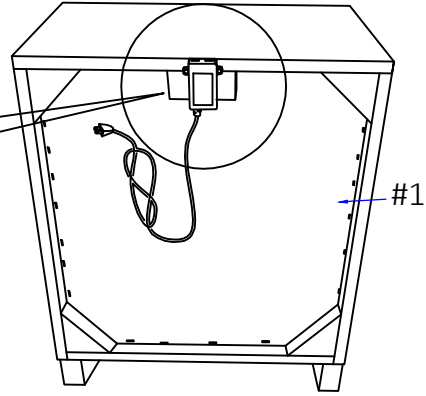
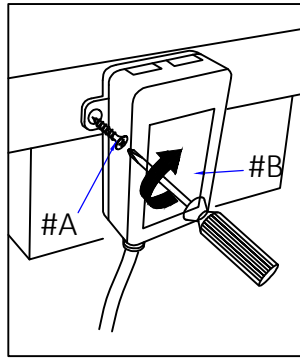

REMARK :
The USB assembly position on customer desires.

BACK VIEW

2

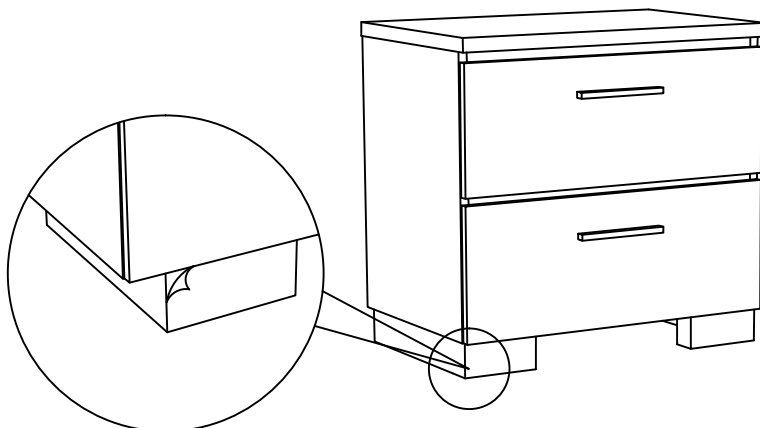

PLEASE REMOVE THE PROTECTIVE FILM
BEFORE USE

ASSEMBLY COMPLETED



Please ensure the furniture rests on an even and flat surface. If the product wobbles or feels loose, double-check all bolts and/or screws are properly tightened and secured.



Keep this handy!

Please retain this instruction manual and any order-related information for future reference.



Lift, don't drag!

To avoid damage to product please always LIFT the product when transporting or adjusting the placement.