

# Gymnastics Bar

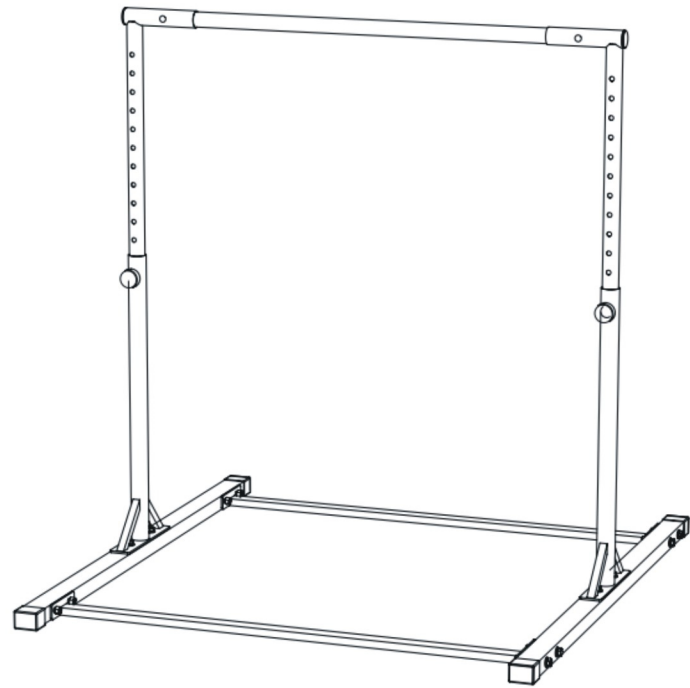









Thank you very much for buying our company's product. To make sure you can use it correctly and safely, please read this manual carefully and store it well.

## IMPORTANT SAFETY INFORMATION

- \*Use it only on stable and even surfaces.
- \*Keep it away from fire.
- \*Stop using it when you hear the sound to be unusual.
- \*Please assemble it with others together.
- \*Please take care that there is no children around when you assembling.
- \*Please check the screws' tightness regularly.
- \*Do not knock the machine with hard subjects.
- \*Do not use volatile oil, thinner or other organic solvent to clean dirt.
- \*Do not use this machine in moisture place.
- \*Please store it in drafty place.
- \*Do not attach sticky subjects (such as tape, eraser, etc) to the product.
- \*Before using it, please do warm exercise for 5 to 10 minutes.
- \*Do not wear any jewelry when you using this machine.
- \*Please wear suitable clothes when exercising.
- \*Do not over exert yourself. Take a break and have some water in time.
- \*Pregnant and physical weakness please avoid using it.
- \*Make sure there is no people around when using it.
- \*If you experience any pain or unusual discomfort during exercise, stop your workout at once and consult a physician before continuing.
- \*Maximum user's weight 180 kgs.

## Parts

H		H---Knobs -----2pcs
G		G---M12 Elastic washer--12pcs
F		F---M12 Flat washer----12pcs
E		E---M12 Nut-----8pcs
D		D---M8 Nut-----2pcs
C		C---M12X20 Screw-----4pcs
B		B---M8X55 Screw-----2pcs
A		A---M12X80 Screw-----8pcs
		Open Spanner-----2pcs

## Assembly Instructions

**Step1:** Lay down the four foot pipes on a flat surface.Fix the four pipes with A,E,F,G each 8pcs.

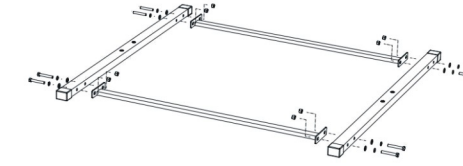

① Ax8 Ex8 Fx8 Gx8

**Step 2:** Fix the two vertical pipes with C,F,G, each 4pcs.

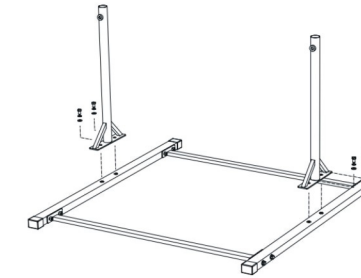

② Cx4 Fx4 Gx4

**Step 3:**Insert the wood bar into the adjuster pipes ,and fix with B , D each 2pcs.

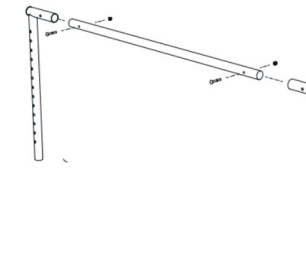

③ Bx2 Dx2

**Step 4:**Connect the adjuster pipes and the vertical pipes ,use the knobs H 2pcs .



④ Hx2

## Assembly Is Now Complete

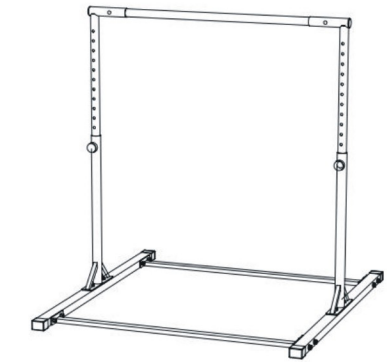

## Import:

How to adjust the height?

Loosening the knobs H 1-2circles→Pull the knobs→Adjust the height →Release the knobs and tighten (Make sure the knob has entered the adjusting hole).

**Note:**The height on both sides must be in the same level.