

ASSEMBLY INSTRUCTION

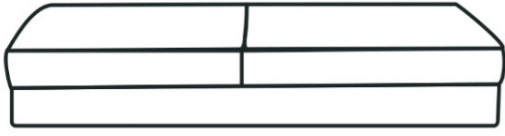

A*1

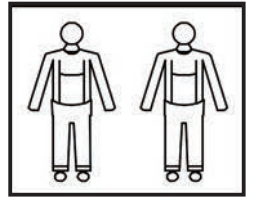

B*1

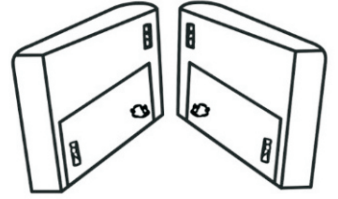

C*2

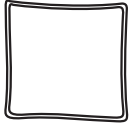

D*4



E*4



F*16

STEP 1:

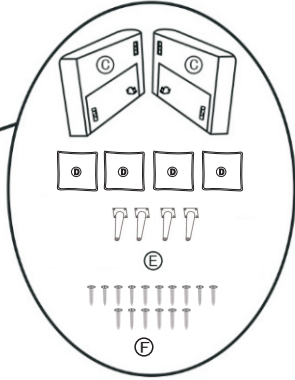
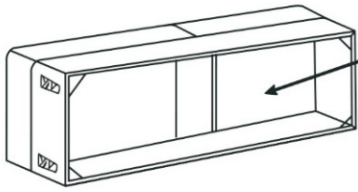

STEP 2:

Take out all the parts in the box, and exhaust the compressed screen package to make it naturally fluffy and pat the bag, the effect will be better if it is exposed to the sun.

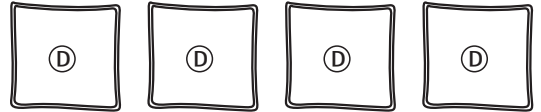

Pay attention Because of the packaging, if there is a crase on the cover, it is not the uality problem of the product. ust iron it with an iron, it will not affect the use.

STEP 3:

Before assembly, you need to prepare screwdriver or electric drill to install the screws of the sofa legs.

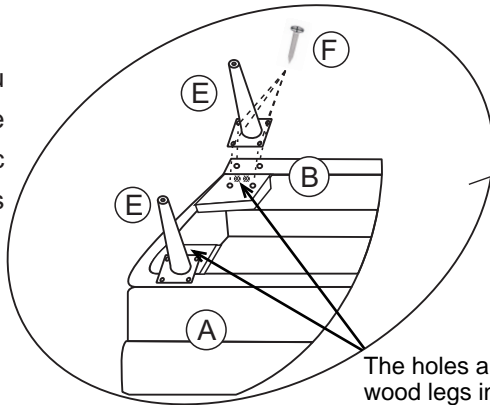

The holes are for wood legs installing only.

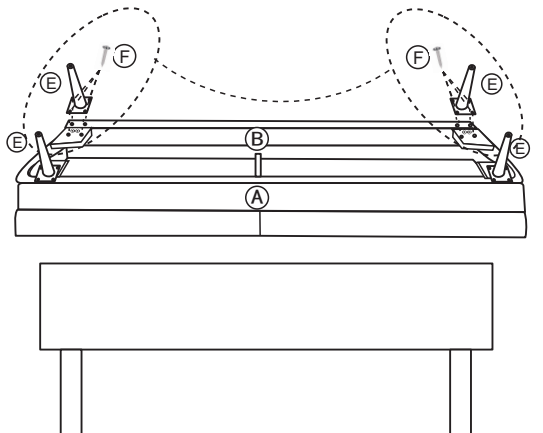

STEP 4:

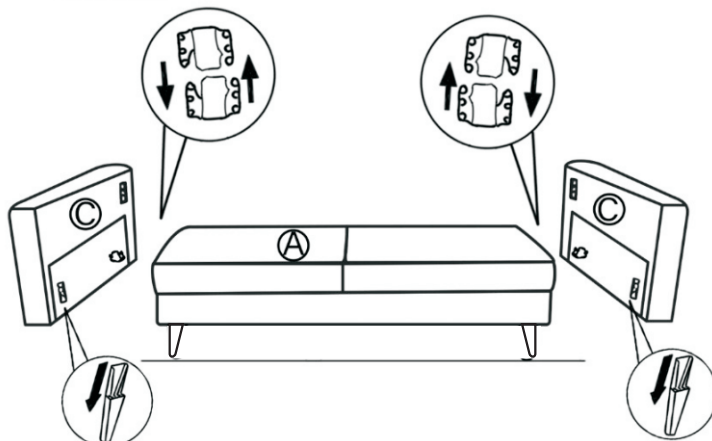

STEP 5:

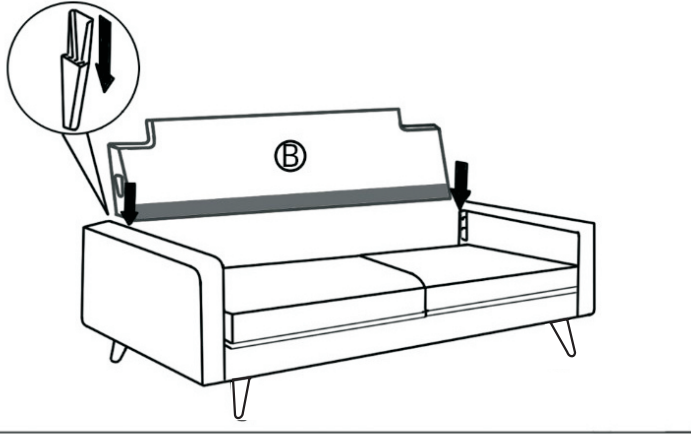

STEP 6:

Lift up the sofa, adjust it to the front, and pull the zipper behind the screen and seat.

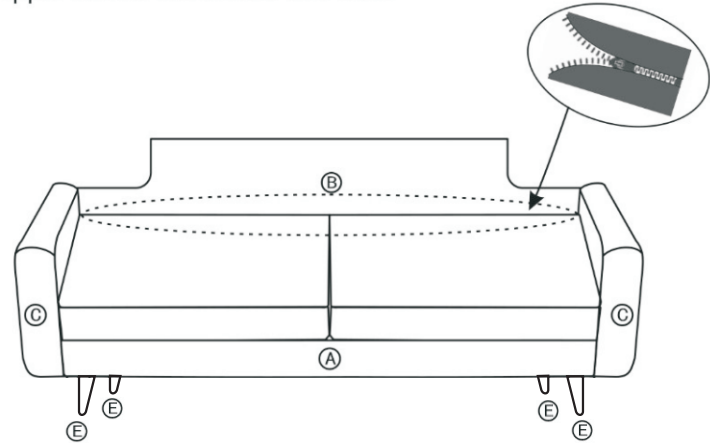

STEP 7:

