

Assembly Instructions

Rosco-32 Outdoor Table



PLEASE NOTE: Check that you have received all components and hardware before assembling. If you are missing any parts, contact your retailer.

1.

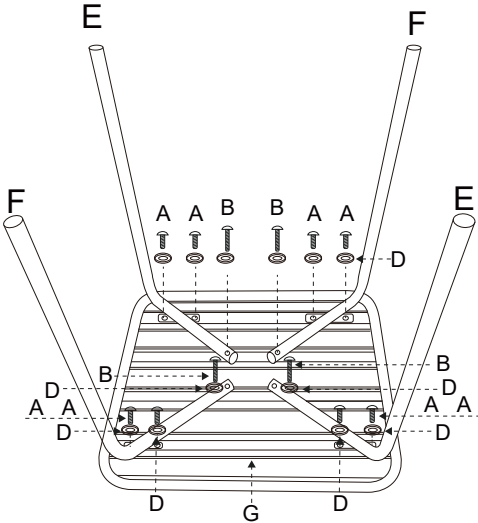

2.

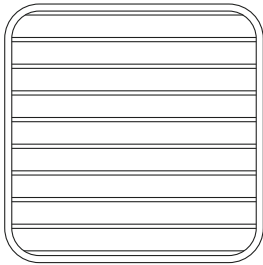
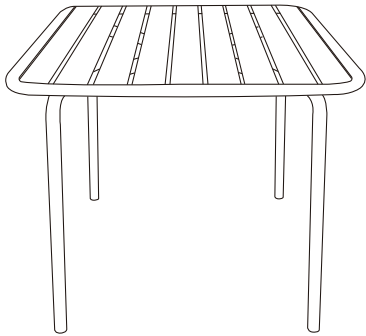

A(8pcs)

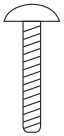

B(4pcs)



C(1pc)



D(12pcs)

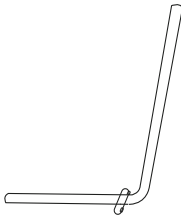

E(2pcs)

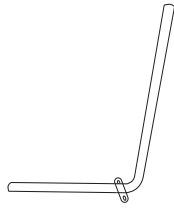

F(2pcs)

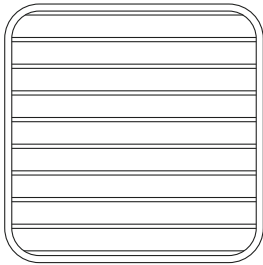

G(1pc)

During assembly, hand tighten screws only. When the screws are in place, tighten completely.