

## CARE AND MAINTENANCE

Spot clean using a mild water-free solvent. Only a professional cleaner should undertake a complete overall cleaning.

The use of steam or water-based cleaners may cause excessive shrinking or staining.







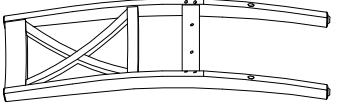
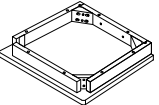
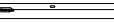

## NOTICE

\* Please make sure that you have all parts indicated before you begin assembly of this item

\* This item should be assembled on a soft surface to prevent scratching the finish during assembly

\* This item may require periodic tightening.

### PART LIST AND HARDWARE LIST

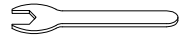
PIECE	DESCRIPTION	PICTURE	QUANTITY
A	BACK CHAIR		1X
B	SEAT FRAME		1X
C	FRONT LEGS (R & L)		2X
D	SIDE STRETCHER (R & L)		2X
HW1	LONG BOLT	6.3*1.3*75 mm 	4X
HW2	SHORT BOLT	6.3*1.3*40 mm 	2X
HW3	NUT	7.8 mm 	4X
HW4	SPRING WASHER	8.5 mm 	10X
HW5	WASHER	8.5 mm 	10X
HW6	SCREW	4*38 mm 	4X
HW7	ALLEN KEY	4 mm 	1X
HW8	WRENCH	13 mm 	1X

Product Dimensions: 17-1/2"W x 19-1/2"D x 36-3/4"H

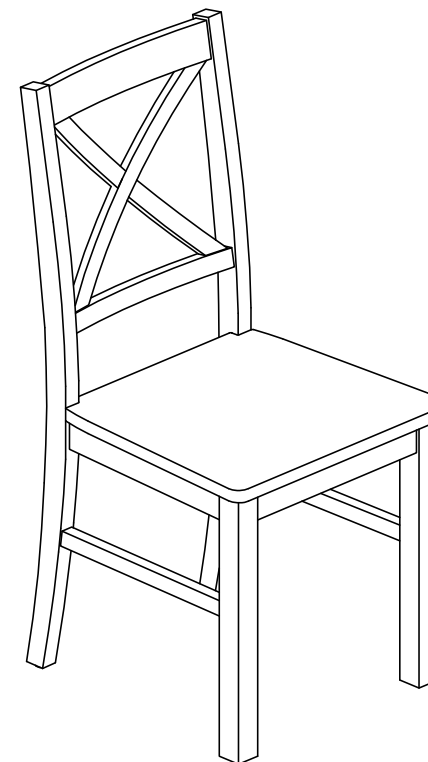

Weight capacity: 275lbs

WARNING: DO NOT STAND ON CHAIR

WARNING: DO NOT OVER TORQUE BOLTS

## PREPARATION

Before beginning assembly of product, make sure all parts are present. Compare parts with package contents list and hardware contents list.  
If any part is missing or damaged, do not attempt to assemble the product.

Estimated Assembly Time: 10 minutes.

Tools Required for Assembly (included): Allen Key

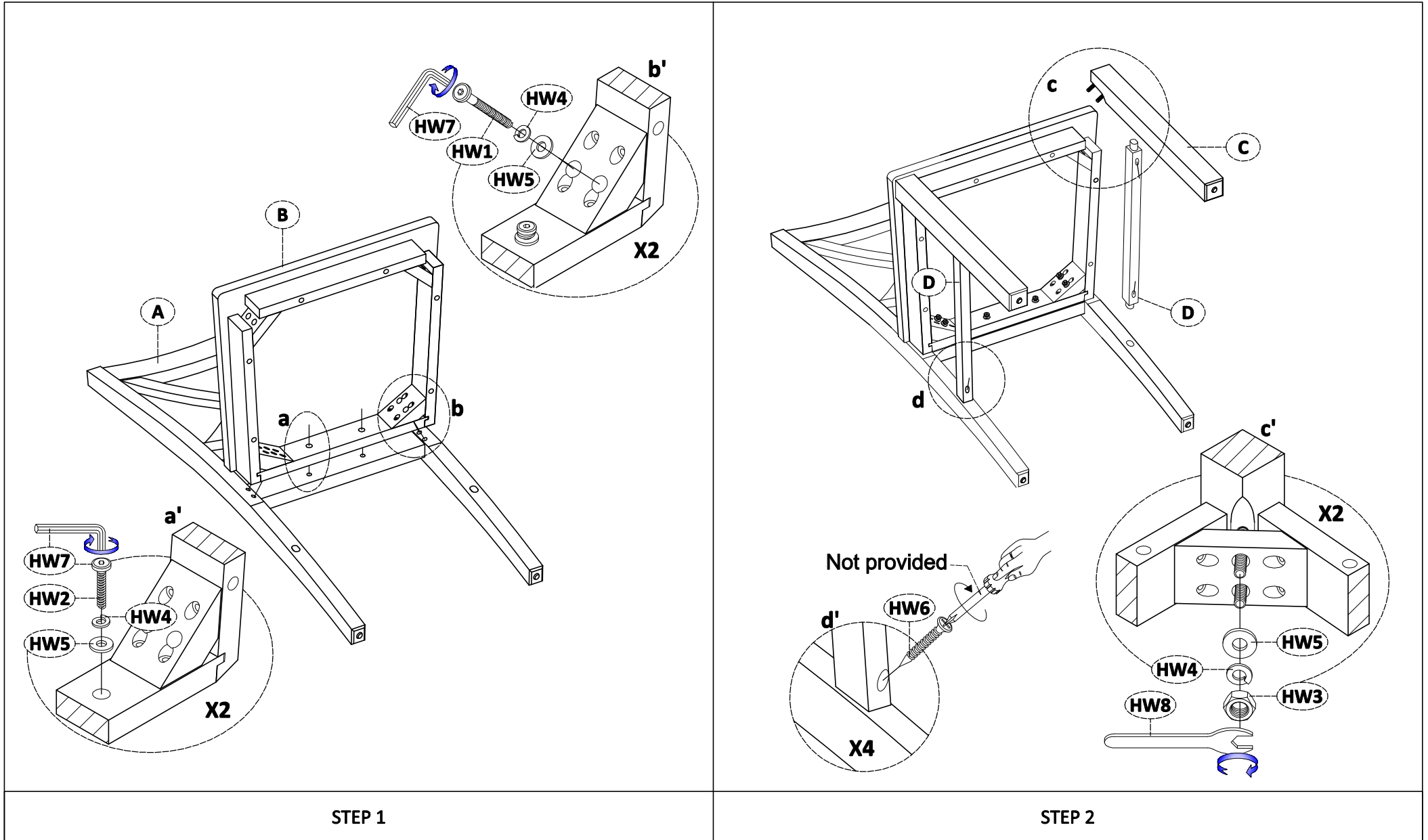

STEP 1

STEP 2