

Instruction Manual

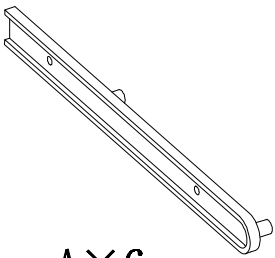

A×6

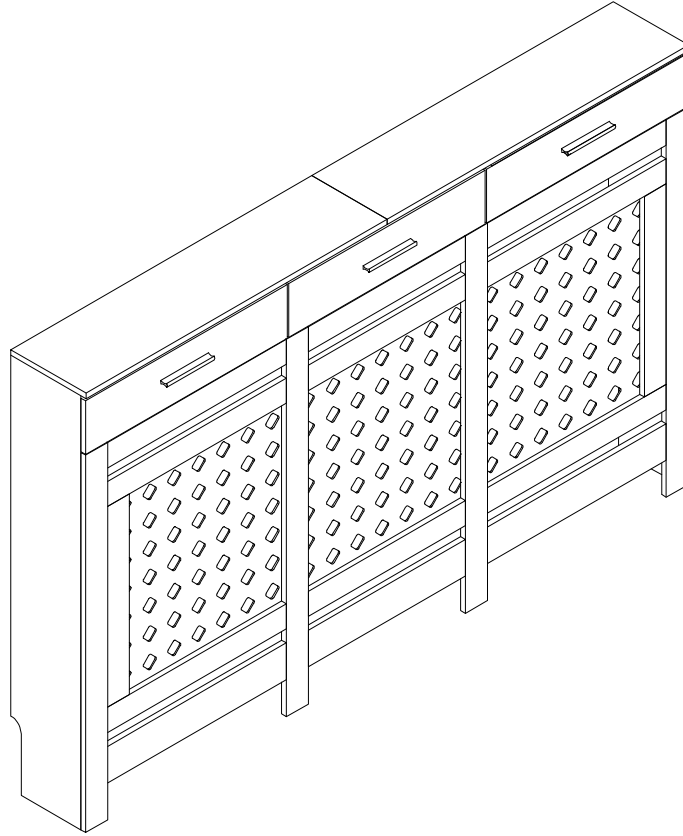

B×64



C×68



D×38

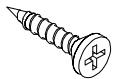

E×24

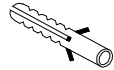

F×2

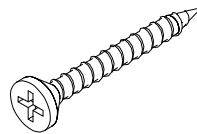

G×12

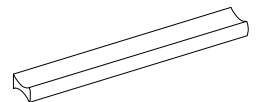

H×3



I×6



J×3

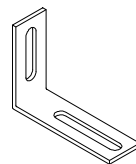

K×2



L×2

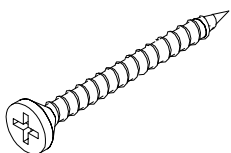

M×2

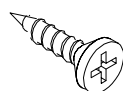

N×15

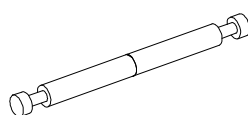

P×2

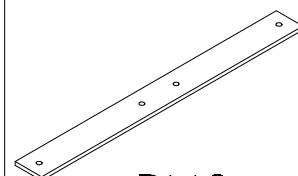

R×2

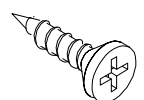

S×8

Exploded View

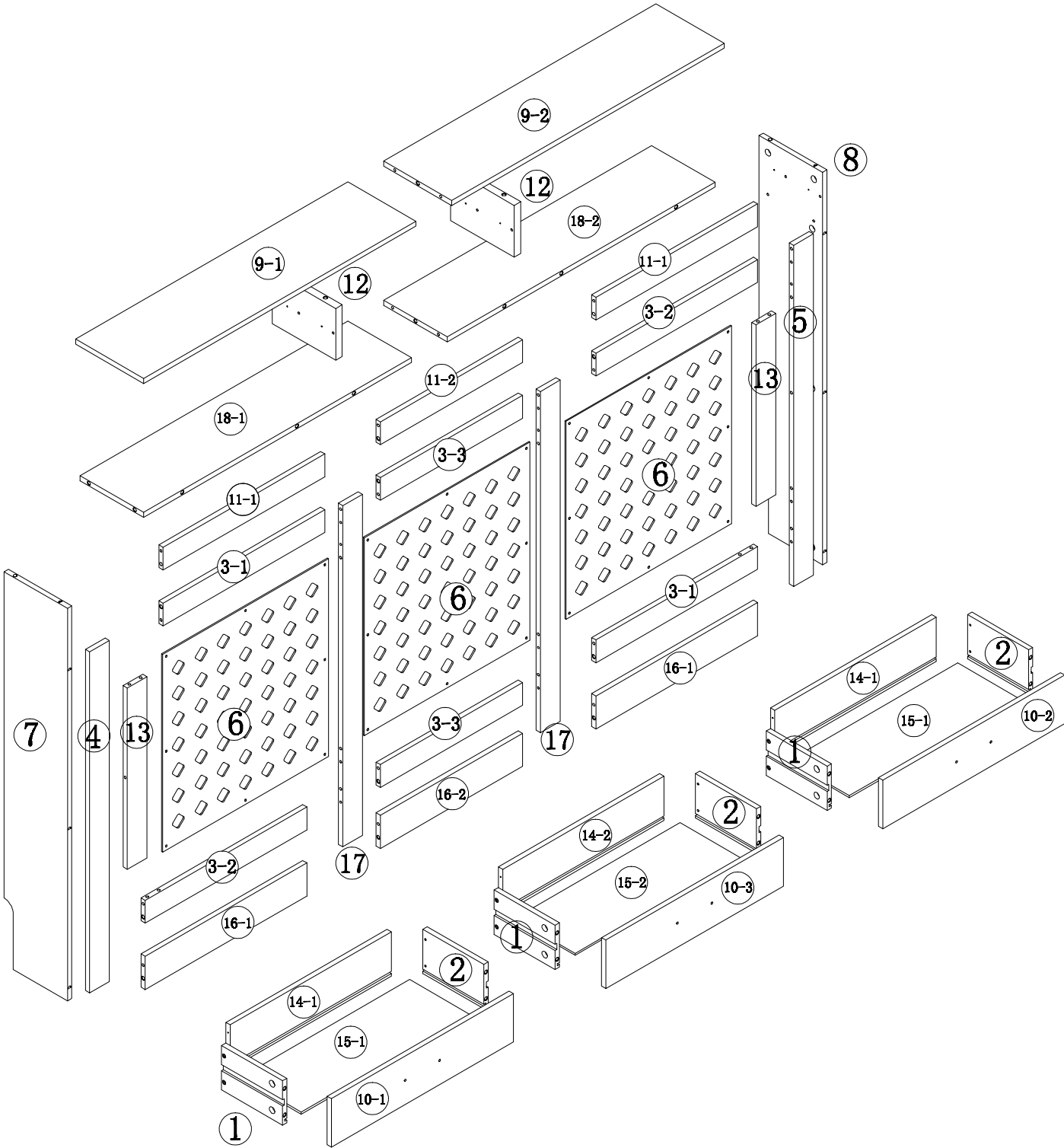

①

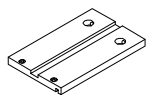

3PCS

②

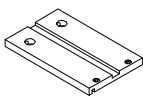

3PCS

③-1

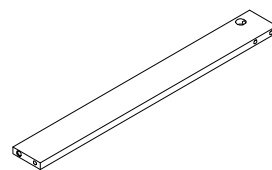

2PCS

③-2

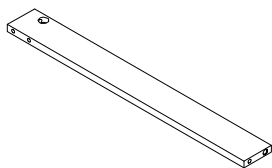

2PCS

③-3

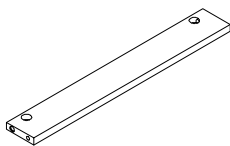

2PCS

④

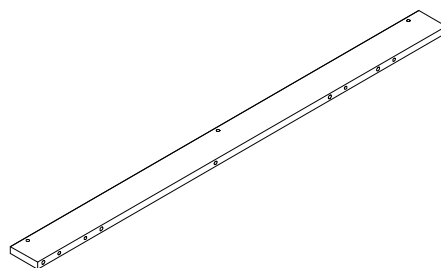

1PC

⑤

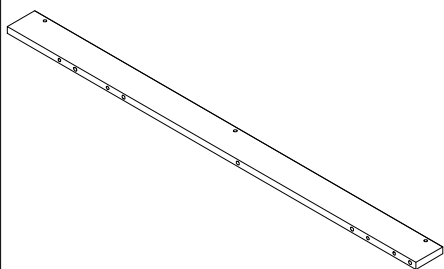

1PC

⑥

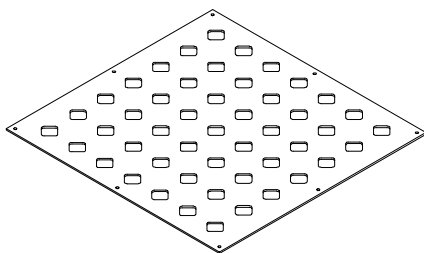

3PCS

⑦

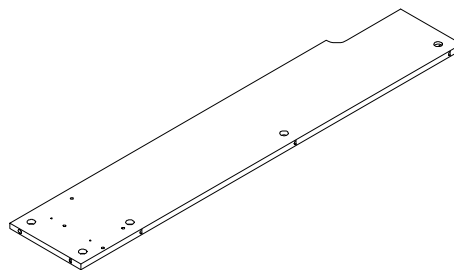

1PC

⑧

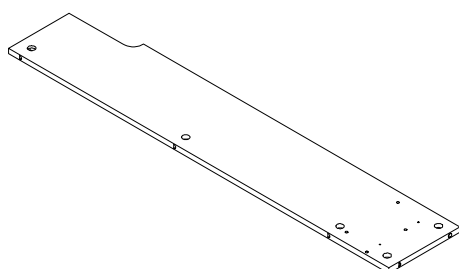

1PC

⑨-1

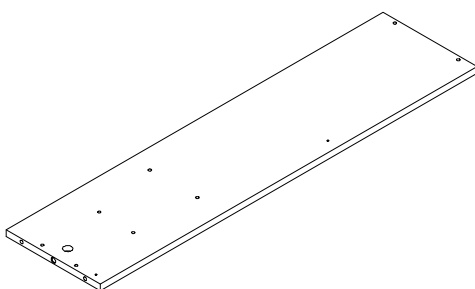

1PC

⑨-2

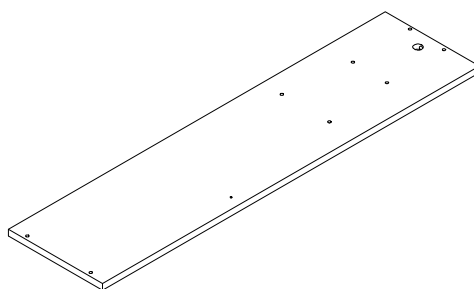

1PC

⑩-1

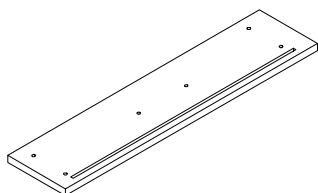

1PC

⑩-2

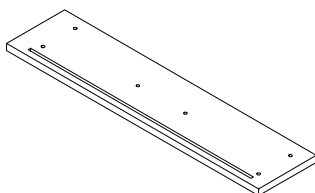

1PC

⑩-3

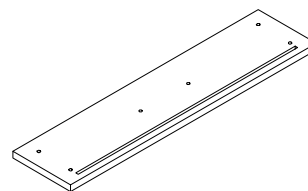

1PC

11-1

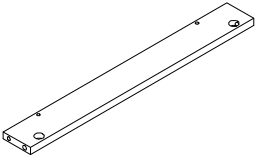

2PCS

11-2

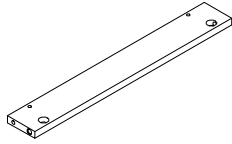

1PC

12

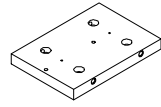

2PCS

13

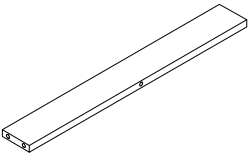

2PCS

14-1

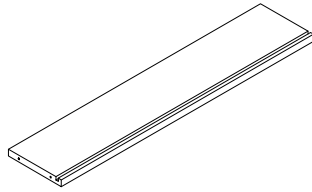

2PCS

14-2

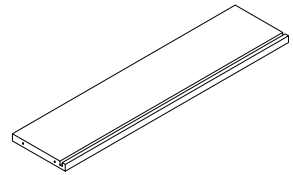

1PC

15-1

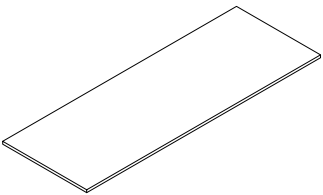

2PCS

15-2

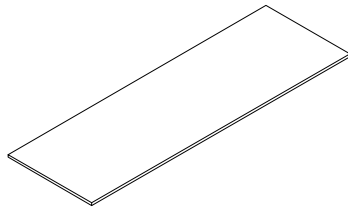

1PC

16-1

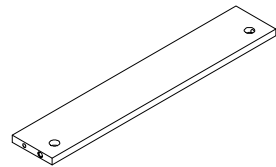

2PCS

16-2

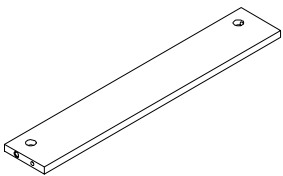

1PC

17

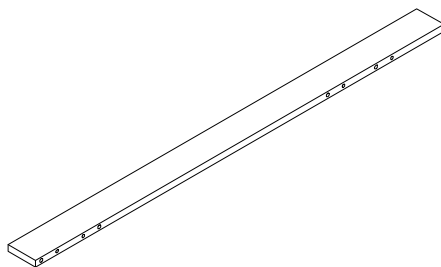

2PCS

18-1

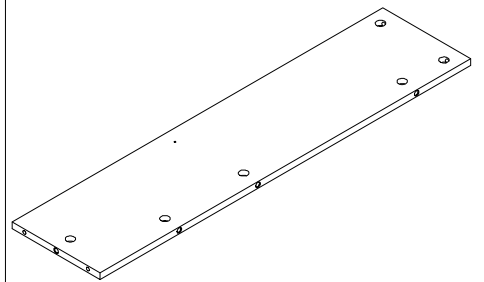

1PC

18-2

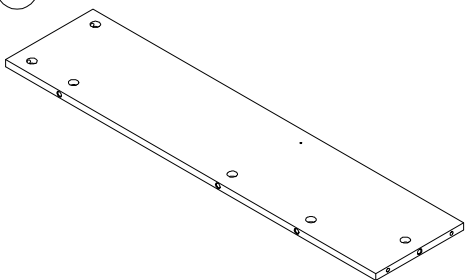

1PC

STEP 1

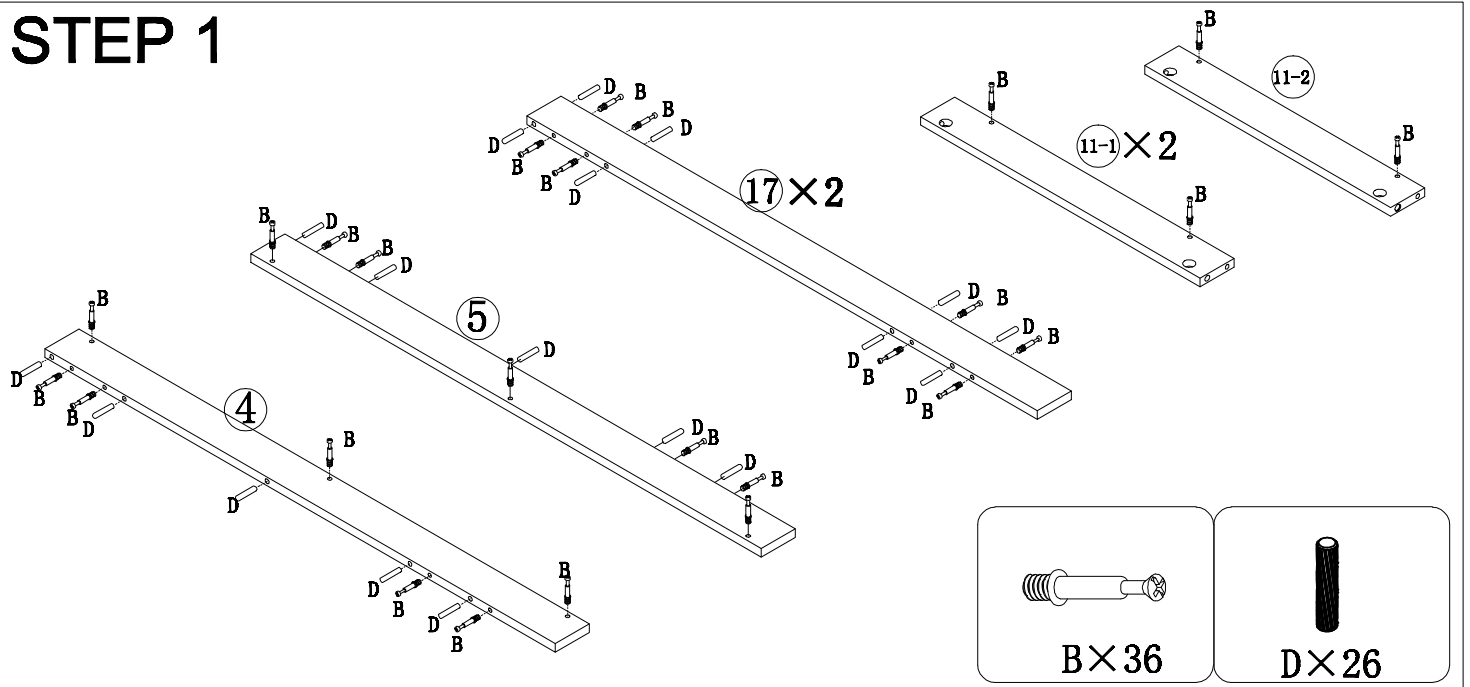

STEP 2

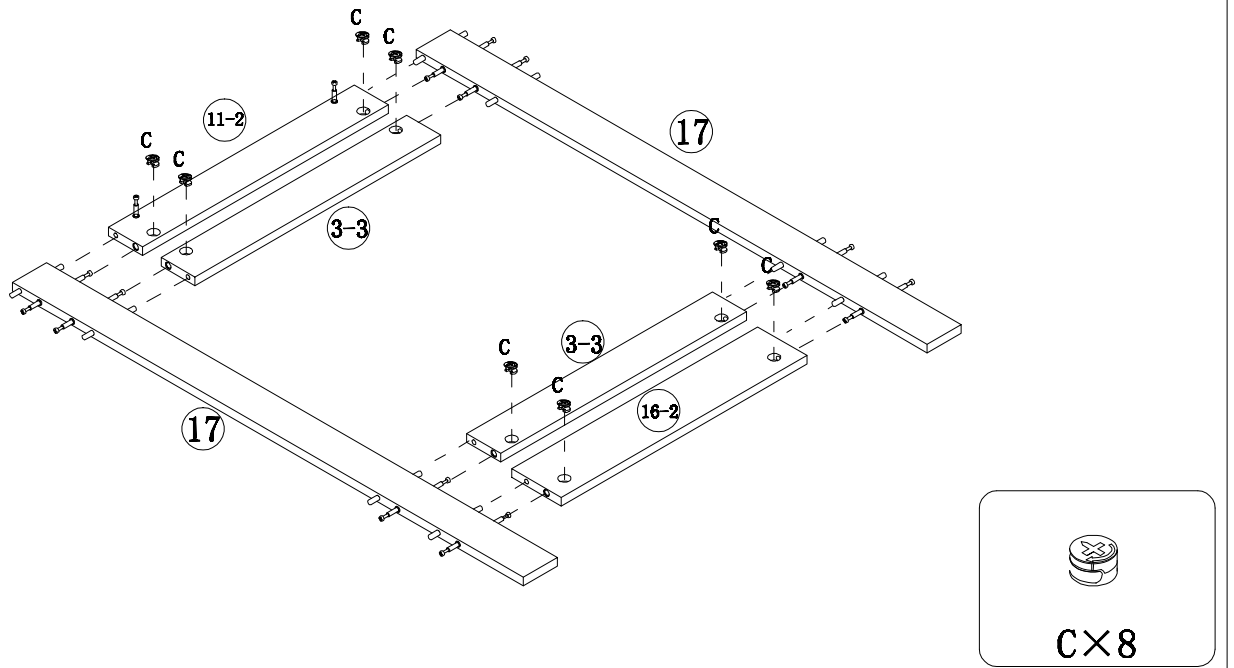

STEP 3

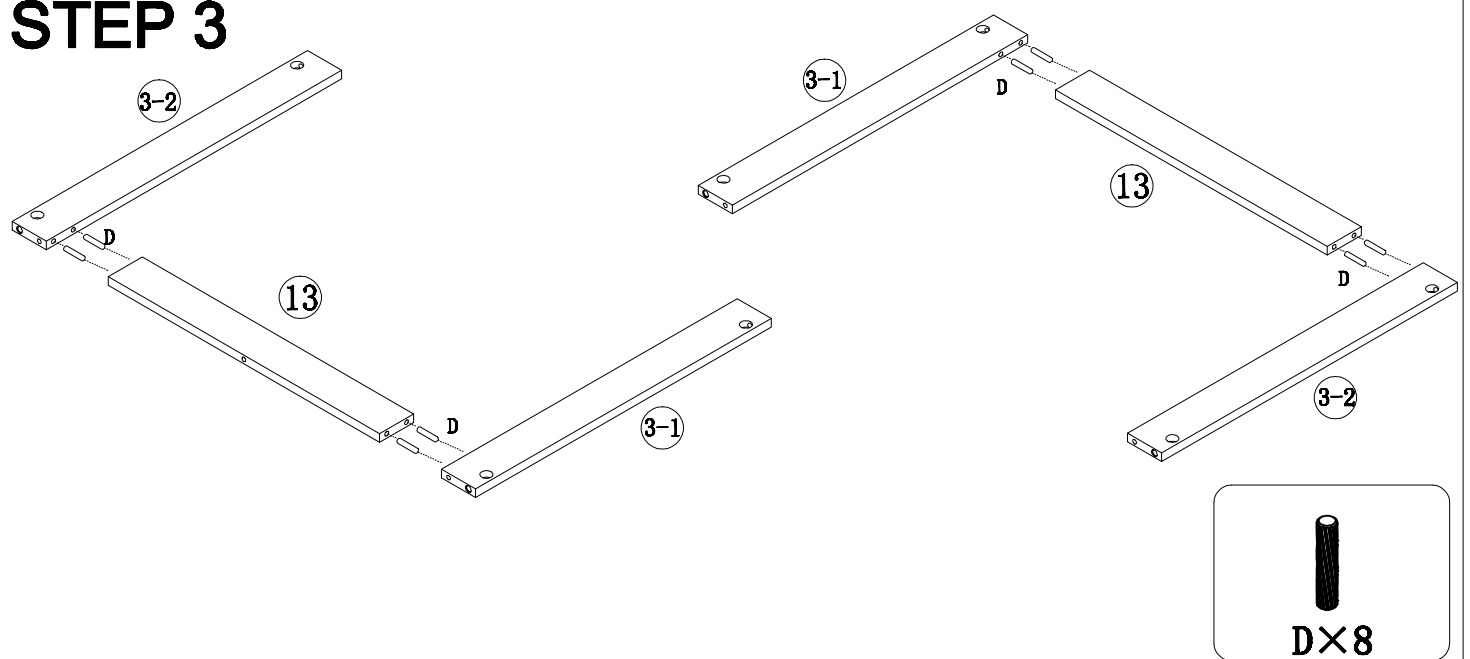

STEP 4

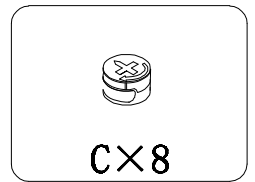
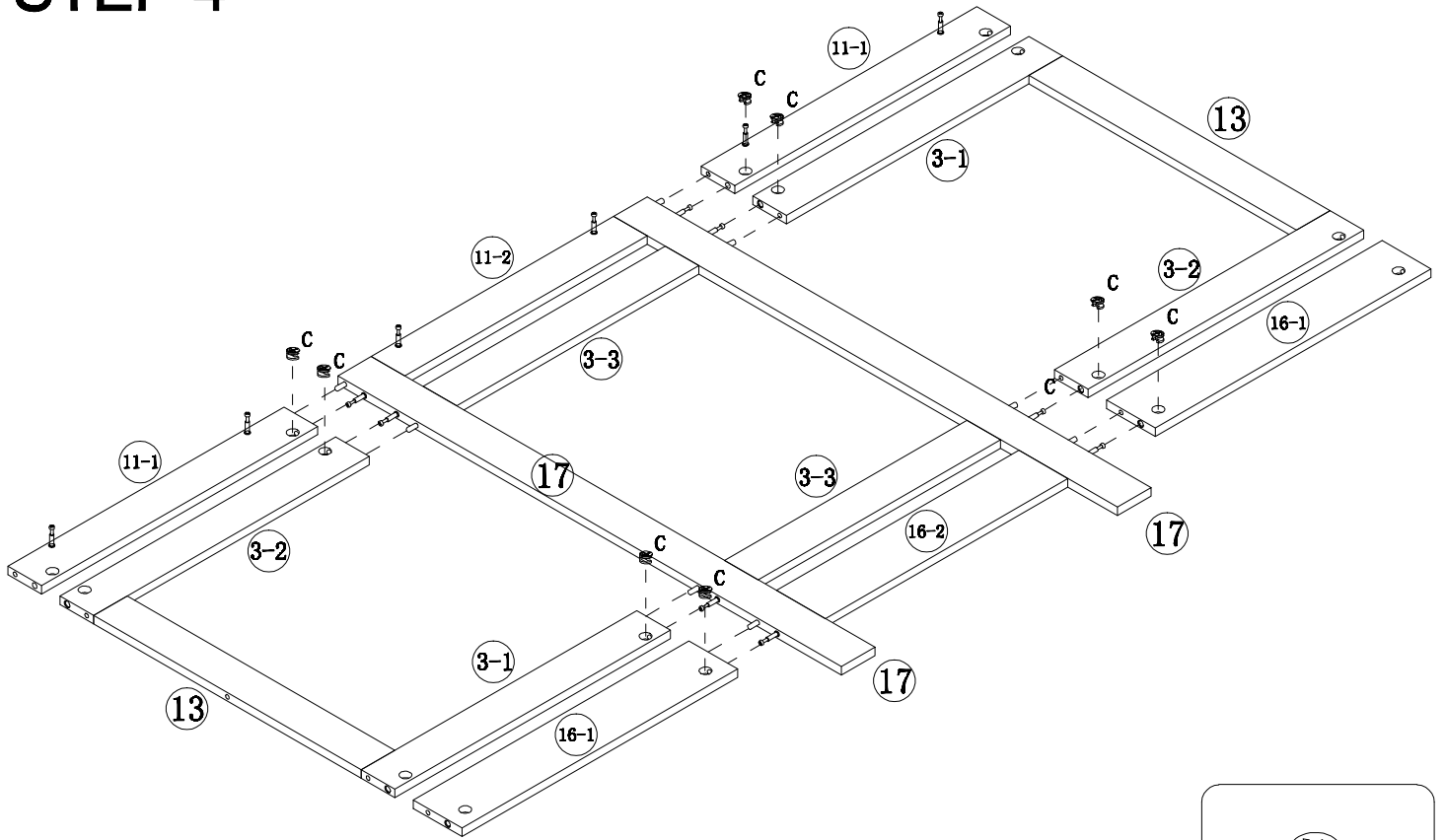

STEP 5

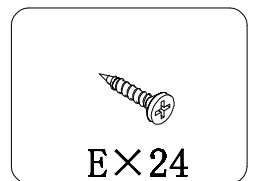
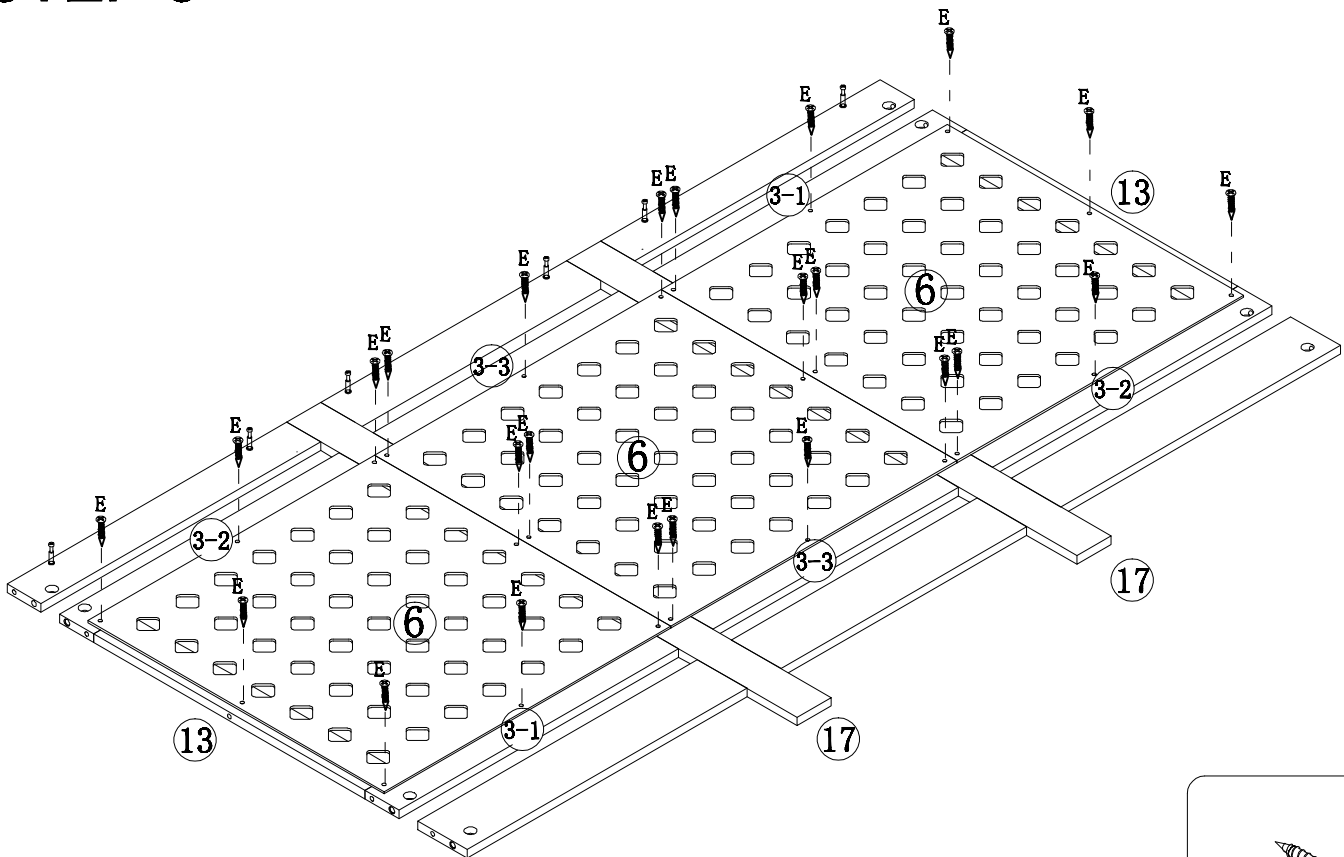

STEP 6

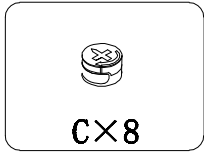
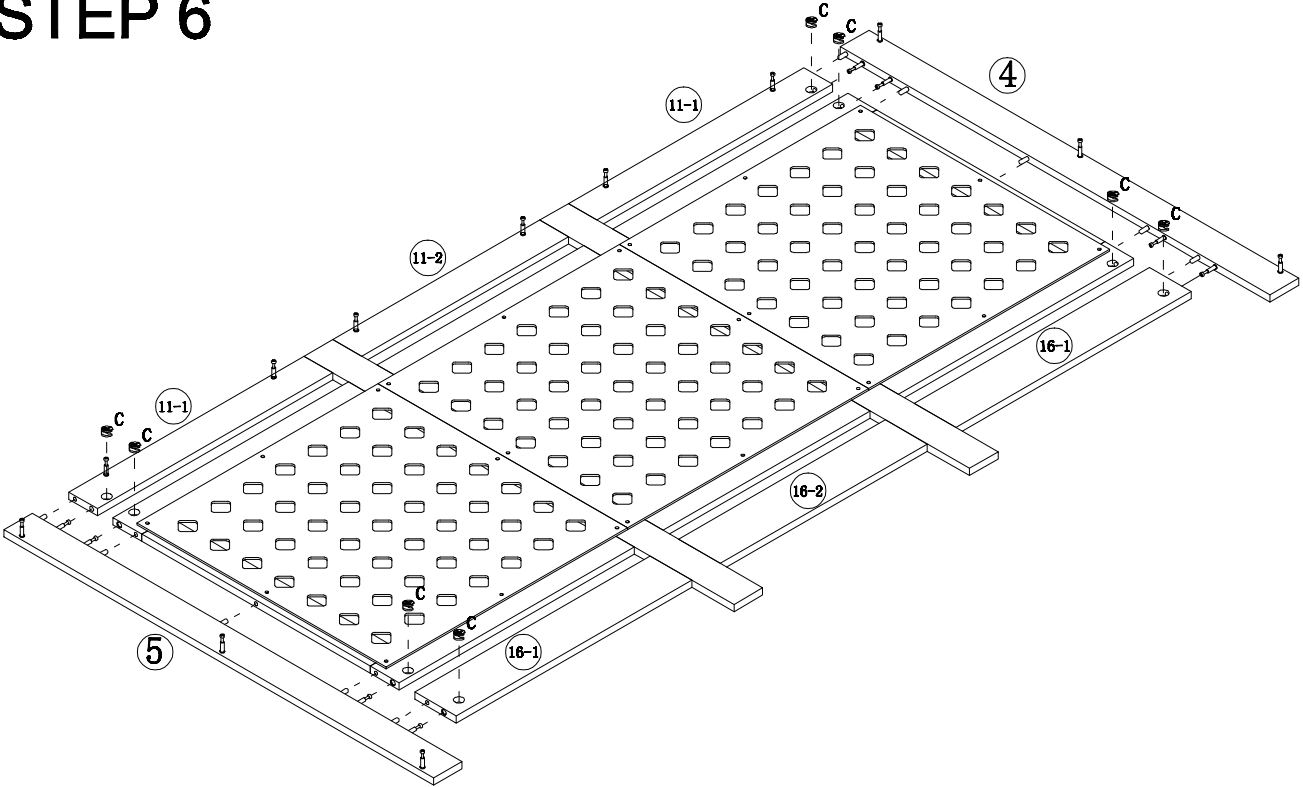



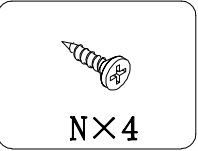
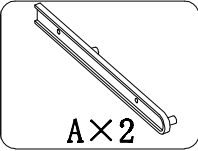
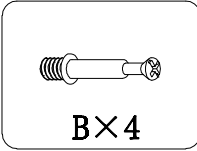
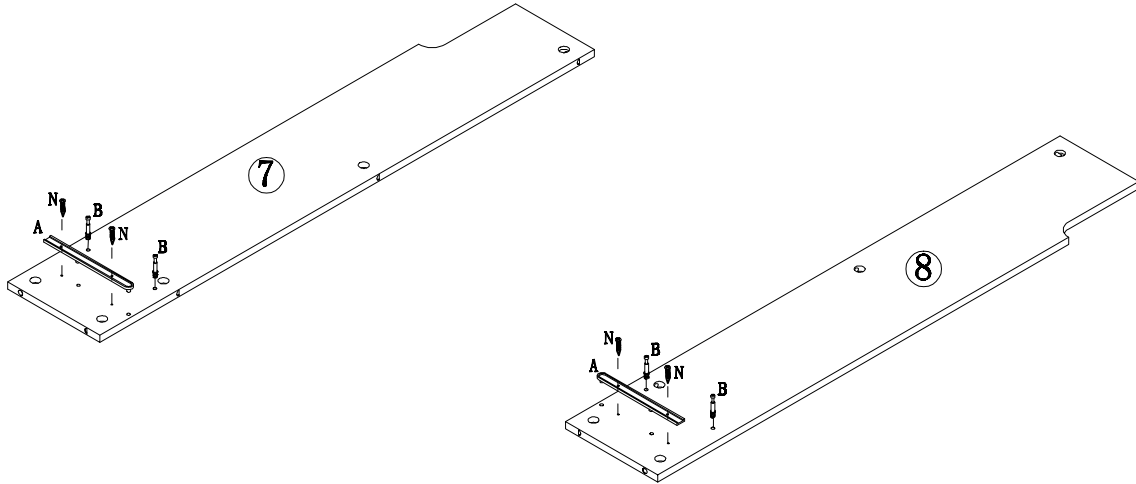

STEP 7

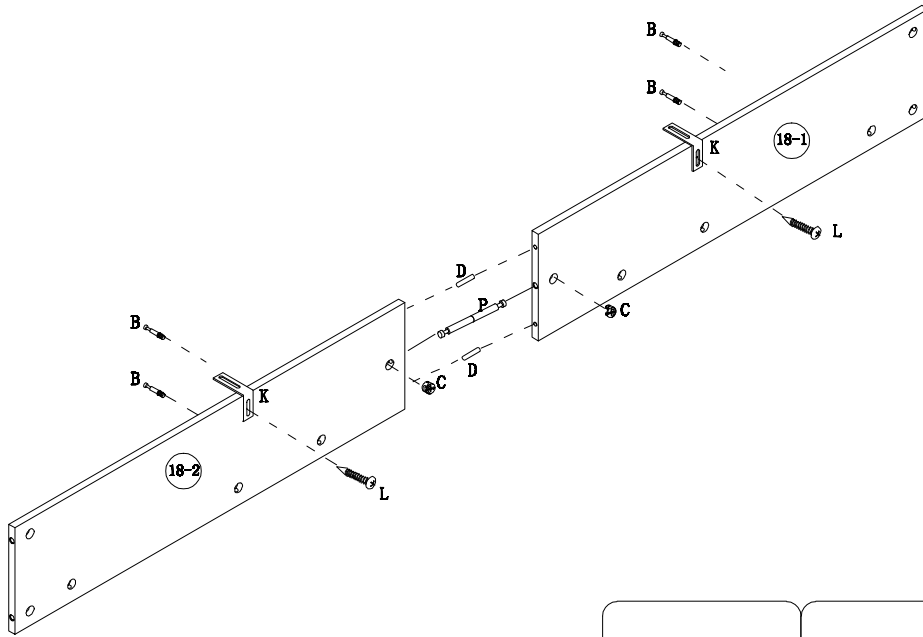

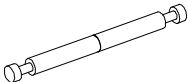

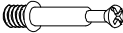
STEP 8

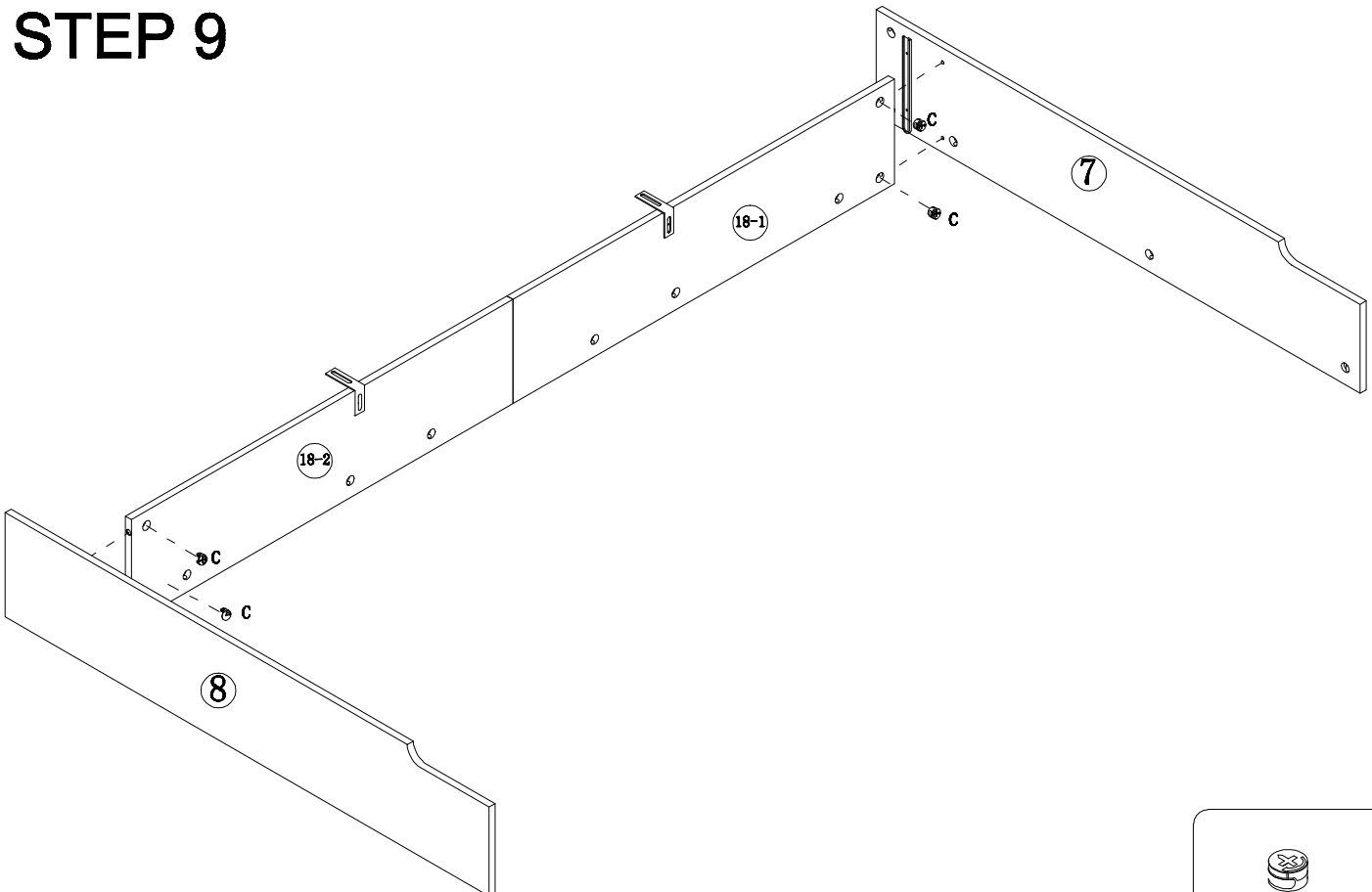

 C×2	 P×1	 D×2
 K×2	 B×4	 L×2

STEP 9



 C×4

STEP 10

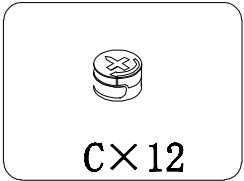
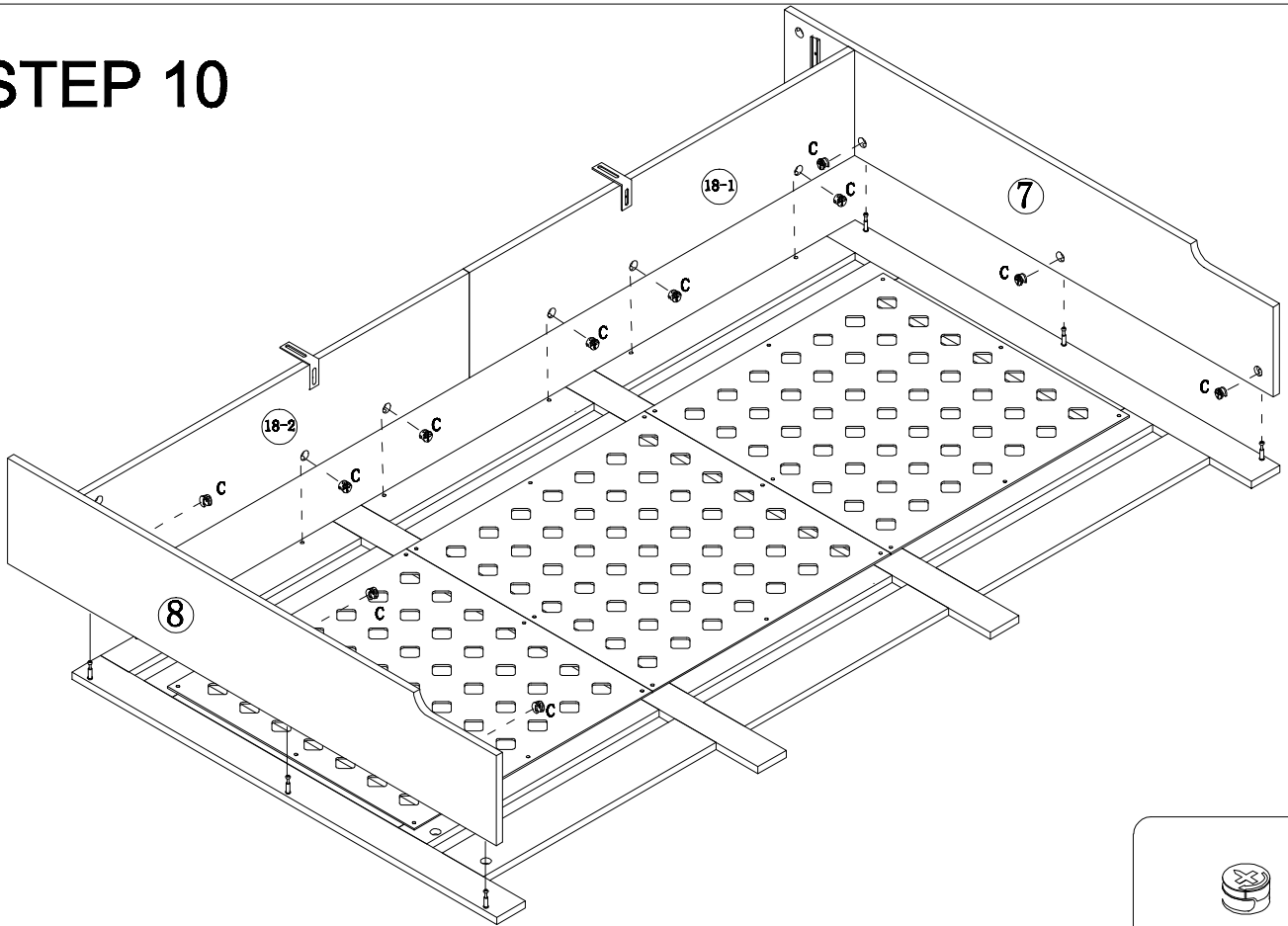

STEP 11

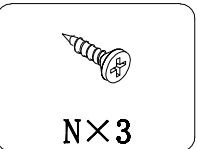
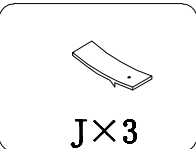
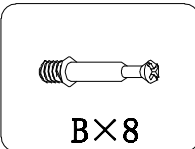
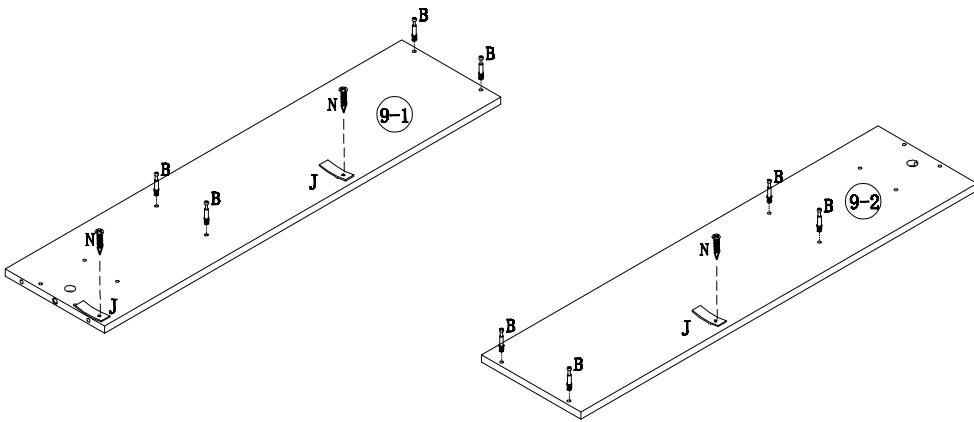

STEP 12

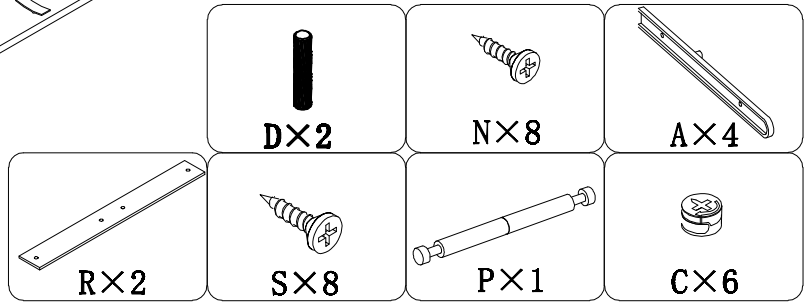
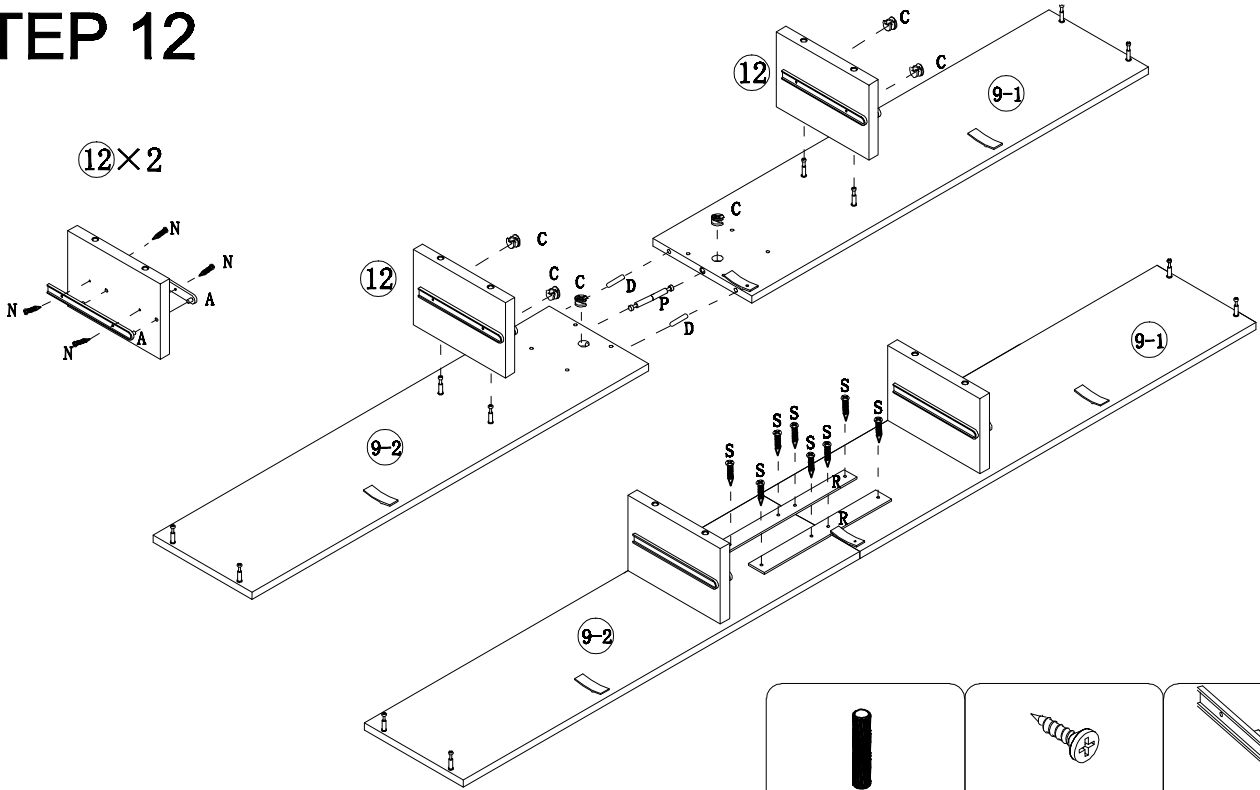

STEP 13

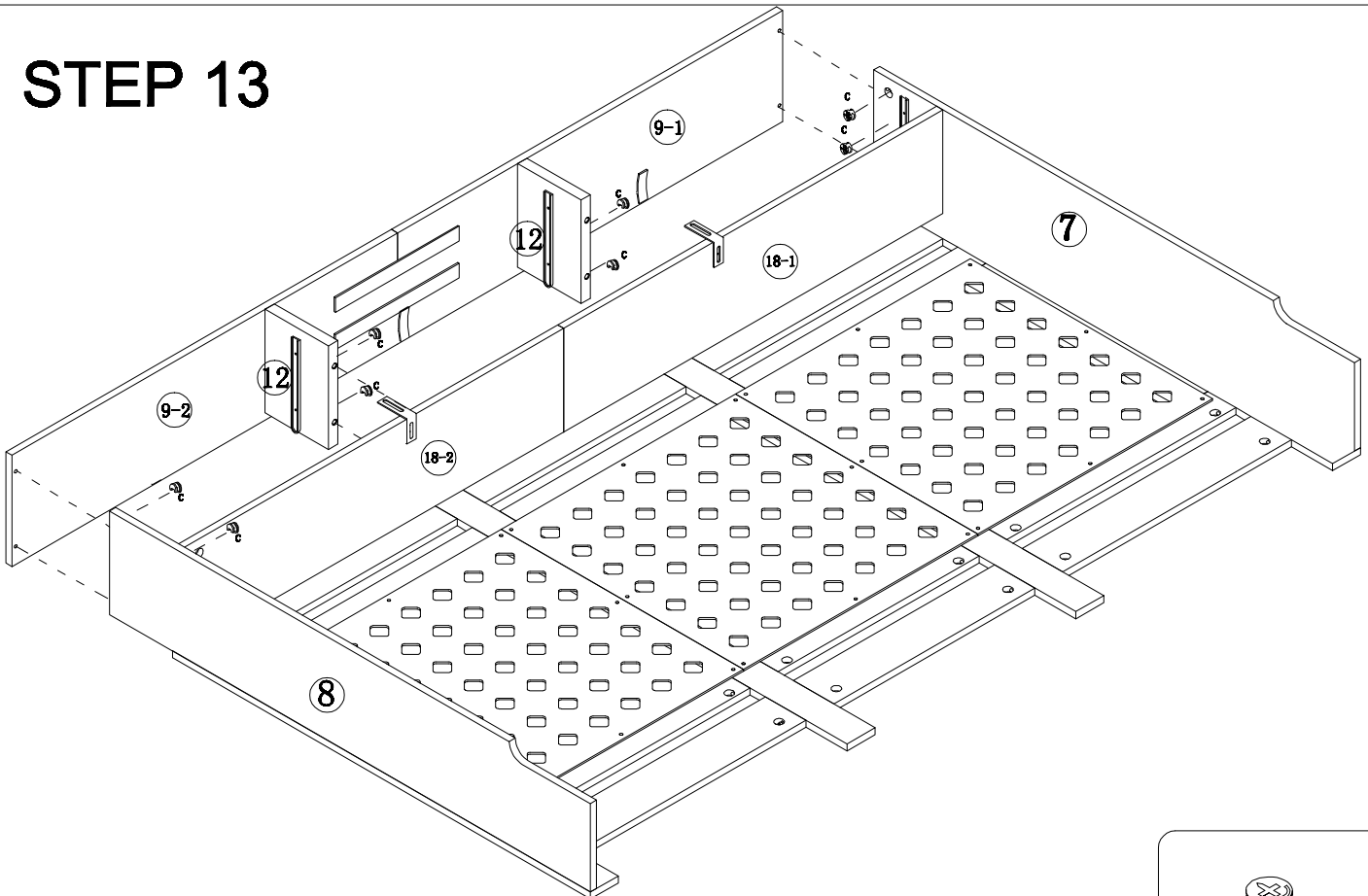

STEP 16

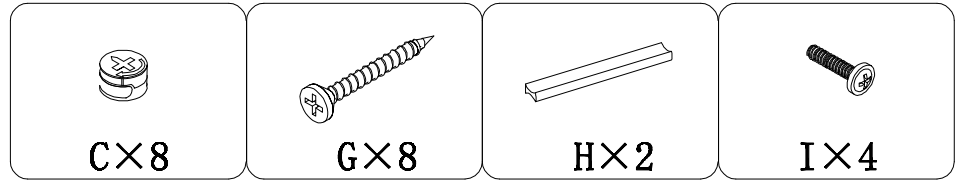
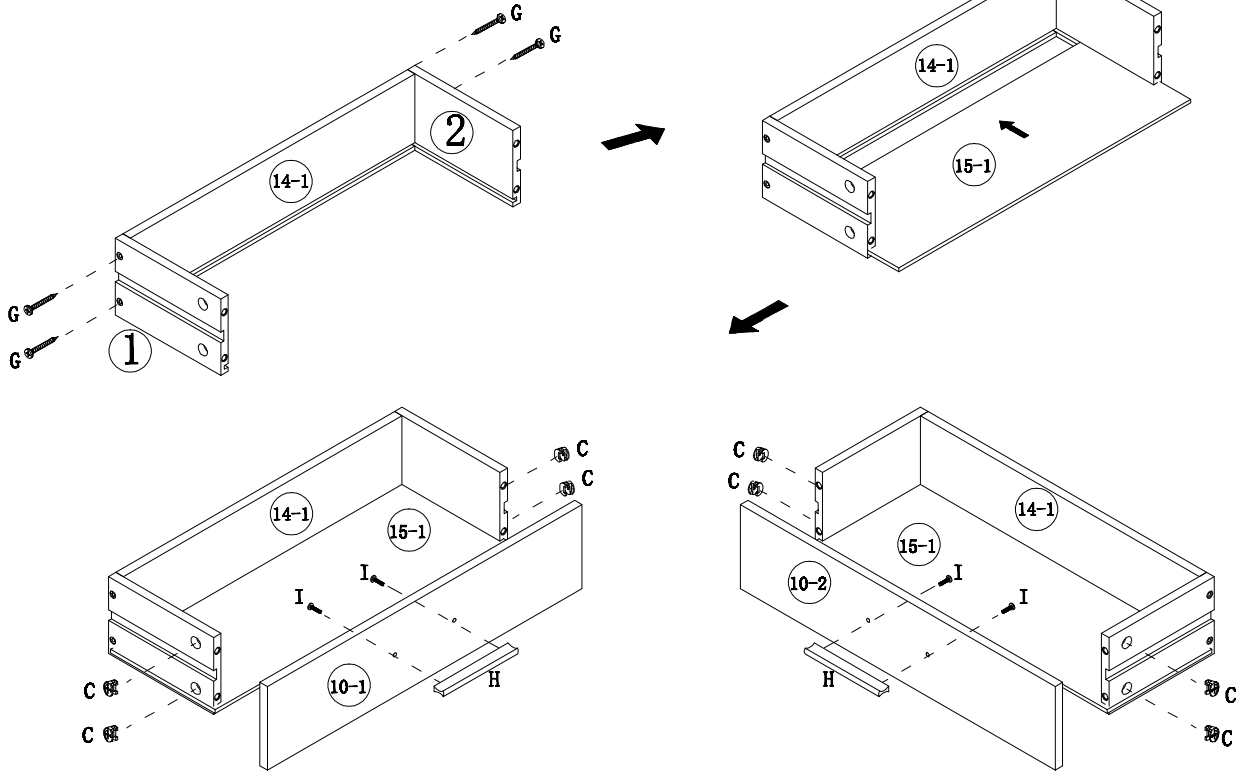

STEP 17

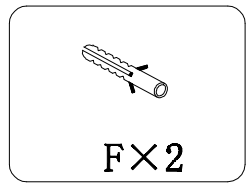
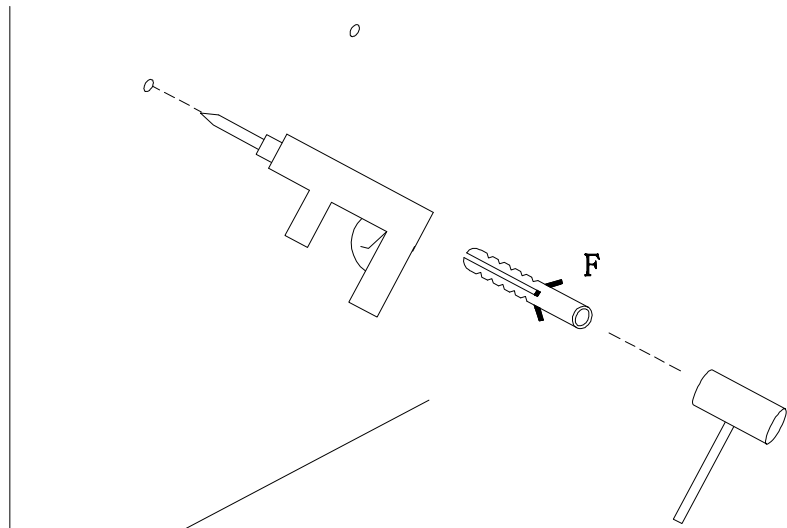

STEP 18

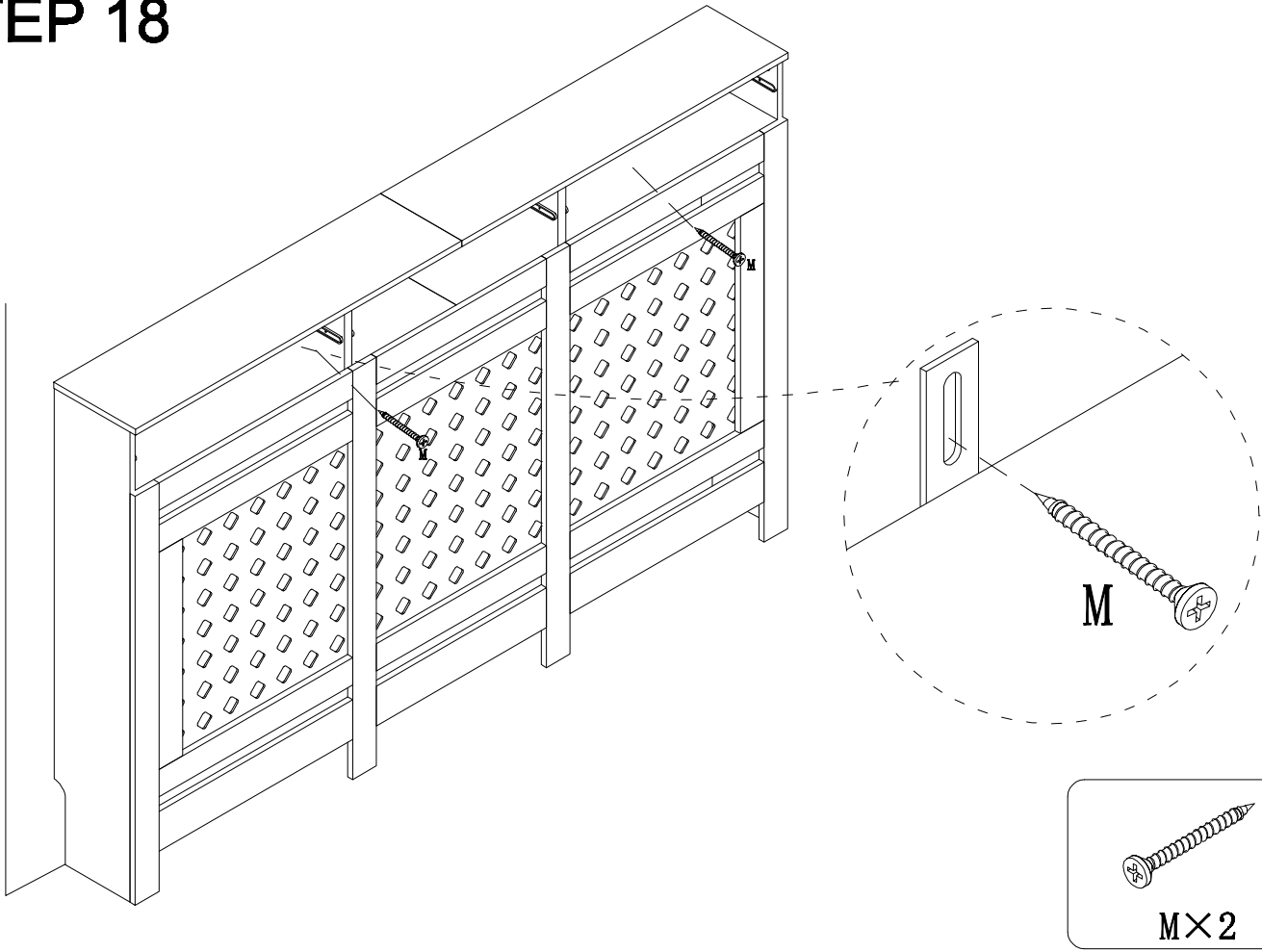

STEP 19

