

60 Inch Corner TV Stand Cabinet

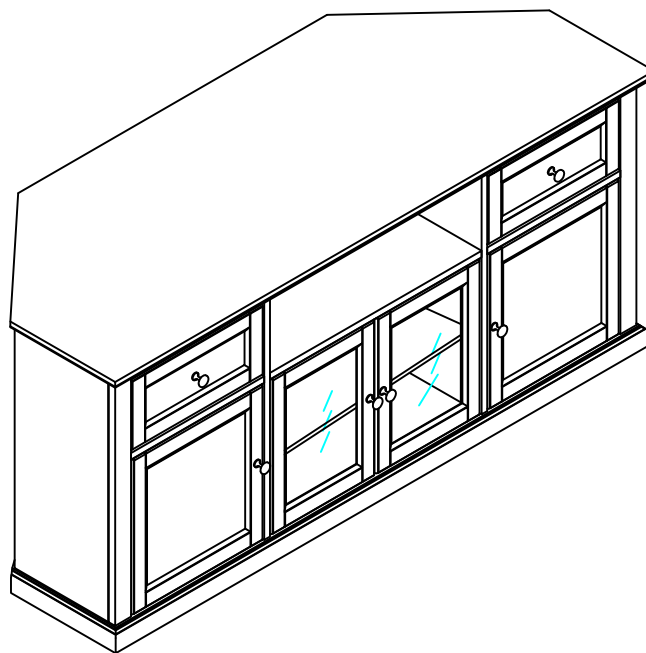



Congratulations! You have purchased a stylish piece. We strive to provide fine furniture products, built with quality materials and hand finished details. Please carefully follow the assembly instructions to ensure your furniture is assembled correctly to provide long lasting enjoyment.

Our products are warranted against defects in material and workmanship for a period of 90 days beginning from the date of sale.

Should you experience any damaged, defective, or missing parts, or need help with assembly, please call us directly before contacting the retailer.

Care: Use a soft clean cloth that will not scratch the surface when dusting. Use of furniture polish is not necessary. Should you choose to use polishes, test in an inconspicuous area first. Use of solvents of any kind may damage your furniture's finish. To clean, simply use a soft clean cloth moistened with lukewarm water, then buff with a dry soft clean cloth.

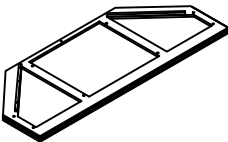
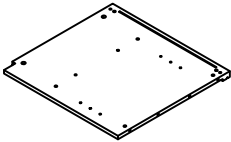
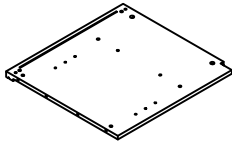
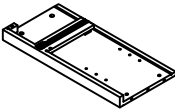
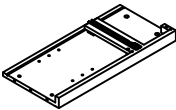
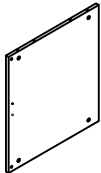

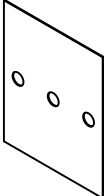
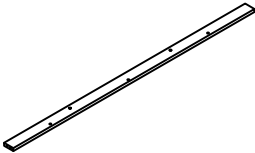
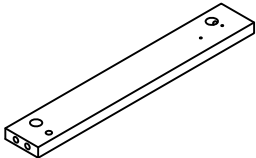
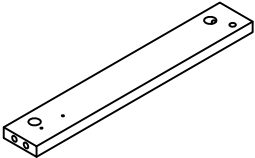
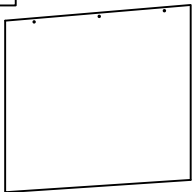
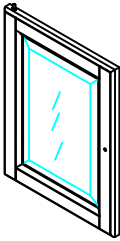
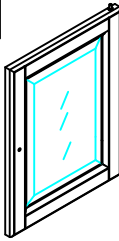
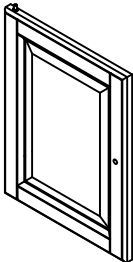
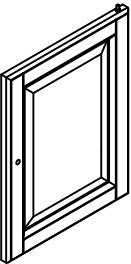
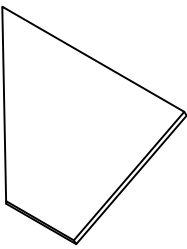
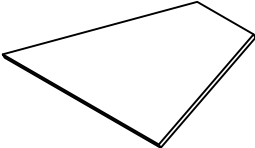
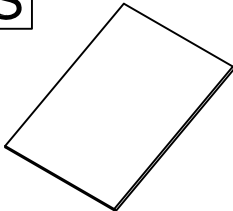
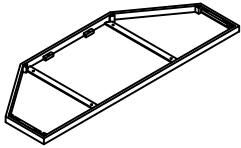
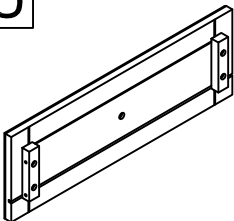
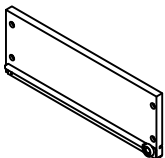
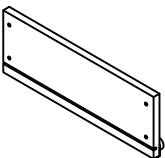
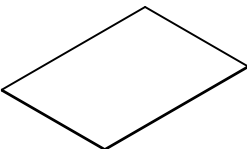
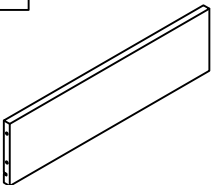

PART LIST

<p>A</p> 	<p>B</p> 	<p>C</p> 	<p>D</p> 	<p>E</p> 
<p>Top 1 PC</p>	<p>Left Vertical Panel 1 PC</p>	<p>Right Vertical Panel 1 PC</p>	<p>Left Side Panel 1 PC</p>	<p>Right Side Panel 1 PC</p>
<p>F</p> 	<p>G</p> 	<p>H</p> 	<p>I</p> 	<p>J</p> 
<p>Fixed Shelf 1 PC</p>	<p>Back Horizontal Rail 2 PCS</p>	<p>Middle Back Panel 1 PC</p>	<p>Top Horizontal Rail 1 PC</p>	<p>Left Horizontal Rail 1 PC</p>
<p>K</p> 	<p>L</p> 	<p>M</p> 	<p>N</p> 	<p>O</p> 
<p>Right Horizontal Rail 1 PC</p>	<p>Side Back Panel 2 PCS</p>	<p>Left Middle Door 1 PC</p>	<p>Right Middle Door 1 PC</p>	<p>Left Side Door 1 PC</p>
<p>P</p> 	<p>Q</p> 	<p>R</p> 	<p>S</p> 	<p>T</p> 
<p>Right Side Door 1 PC</p>	<p>Left Side Adjustable Shelf 1 PC</p>	<p>Right Side Adjustable Shelf 1 PC</p>	<p>Middle Adjustable Shelf 1 PC</p>	<p>Bottom 1 PC</p>
<p>U</p> 	<p>V</p> 	<p>W</p> 	<p>X</p> 	<p>Y</p> 
<p>Drawer Front Panel 2 PCS</p>	<p>Drawer Right Side Panel 2 PCS</p>	<p>Drawer Left Side Panel 2 PCS</p>	<p>Drawer Bottom Panel 2 PCS</p>	<p>Drawer Back Panel 2 PCS</p>

PART LIST

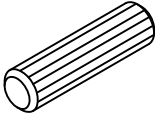
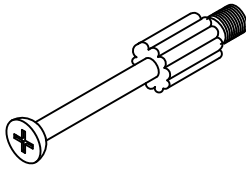
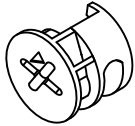
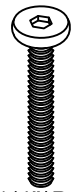
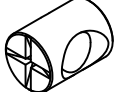
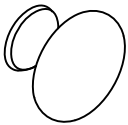
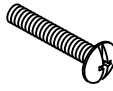
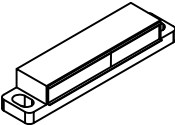
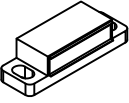
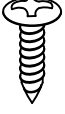
Support Legs 2 PCS

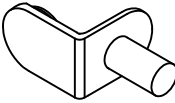
HARDWARE LIST

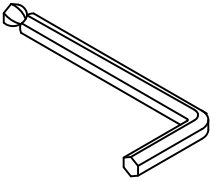
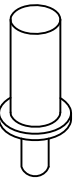
1		2		3		4	 2" x 1/4" D11mm	5	
Wood Dowel 24 PCS	Cam Bolt 22 PCS	Cam Lock 22 PCS	Hex Socket Head Bolt 8 PCS	Barrel Nut 8 PCS					
6		7	 3/4" x 5/32" D9mm	8		9		10	 12mm x 3 D6mm
Knob 6 PCS	Round Head Bolt 6 PCS	Double Door Magnet 1 PC	Door Magnet 2 PCS	Round Head Screw 12 PCS					
11	 1" x 4 D8mm	12	 1-1/4" x 4 D8mm	13		14		15	
Short Screw 16 PCS	Long Screw 5 PCS	Shelf Holder 12 PCS	Adjustable Levelers 6 PCS	Allen Key 1 PC					
16	<div style="text-align: center;">  Pin Hinge (Spare Parts) 8 PCS </div> <p style="text-align: center;">Tools needed: Allen key (part#15)(included) Phillips Head Screw Driver (Not included)</p> <p style="text-align: center;">Note: Wood Dowels are intended for alignment only when assembling your furniture. Additional clearance between the wood dowels & pre-drilled hole is intentional for ease of assembly.</p>								

Step 1. Insert Cam Bolts (part#2) into pre-drilled holes of parts A, B, C, D & E using a Phillips head screw driver as shown. Do not over tighten.

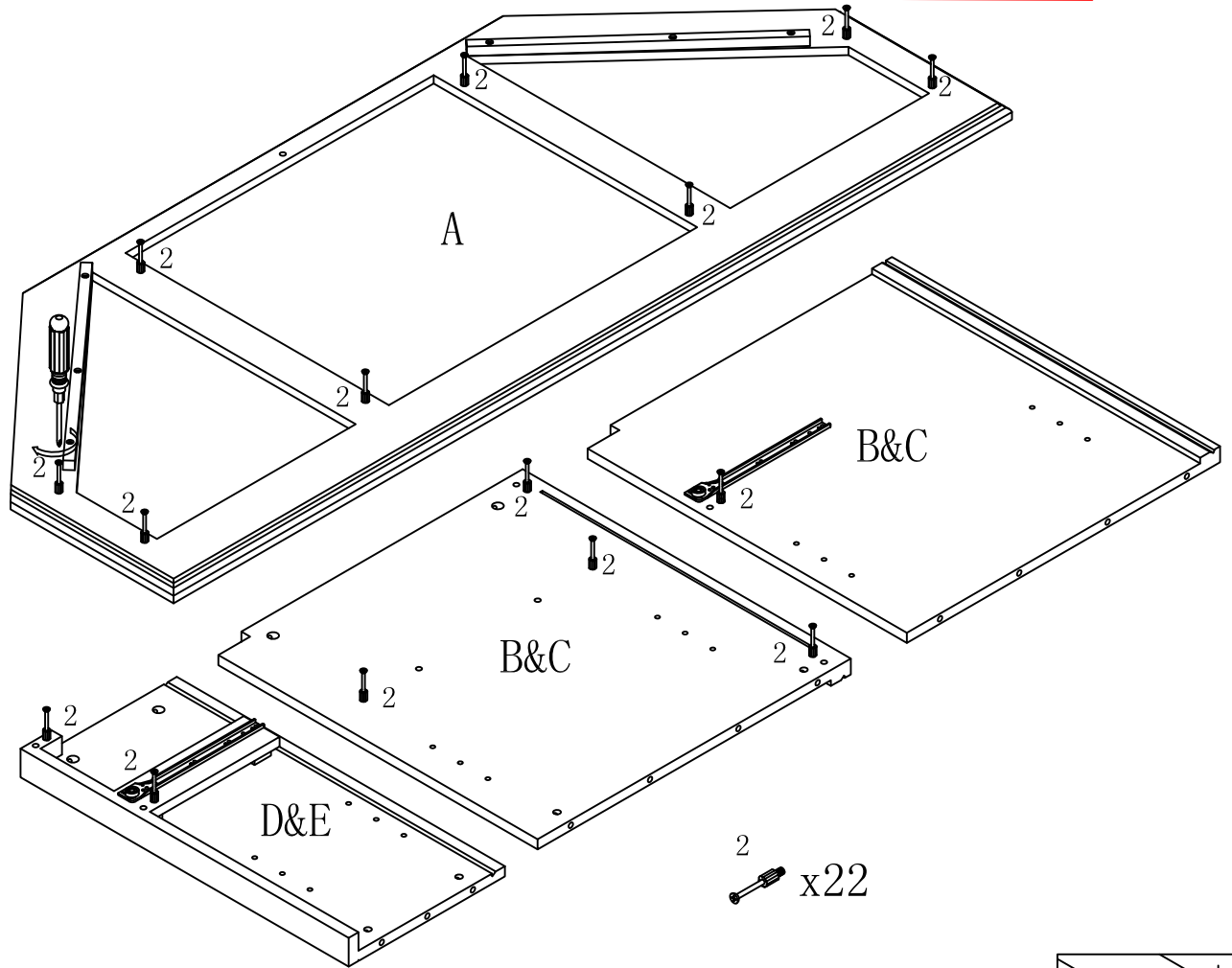

Step 2. Attach Part F to Part B with Cam Locks (Part#3) and Wood Dowel (Part#1). Attach Rail G to Panel B with Cam Lock and Wood Dowel as shown. Slide Middle Bck Panel H into the grooves of Part G as shown.

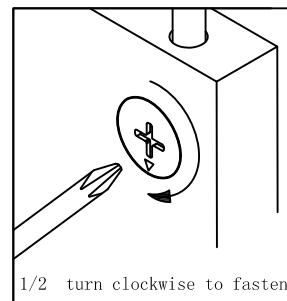
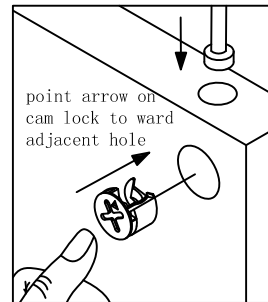
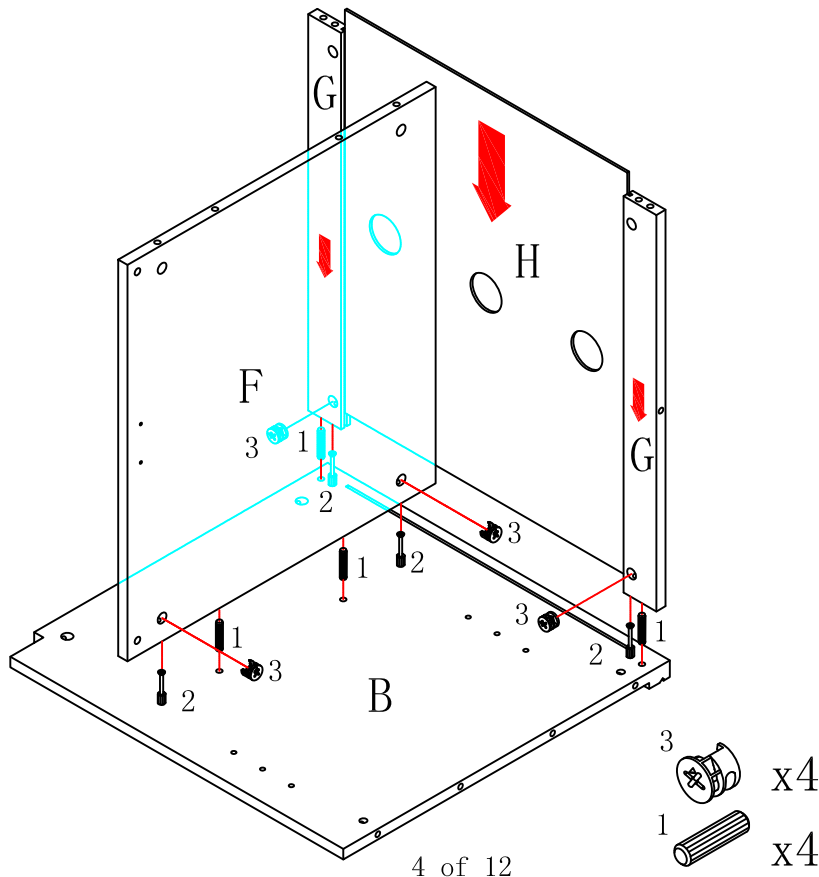

Step 3. Turn the assembled parts F, B, G & H to lay the Part H on the floor. Attach Part C to part F & G with Cam Lock (Part#3) and Wood Dowel (Part#1) as shown.

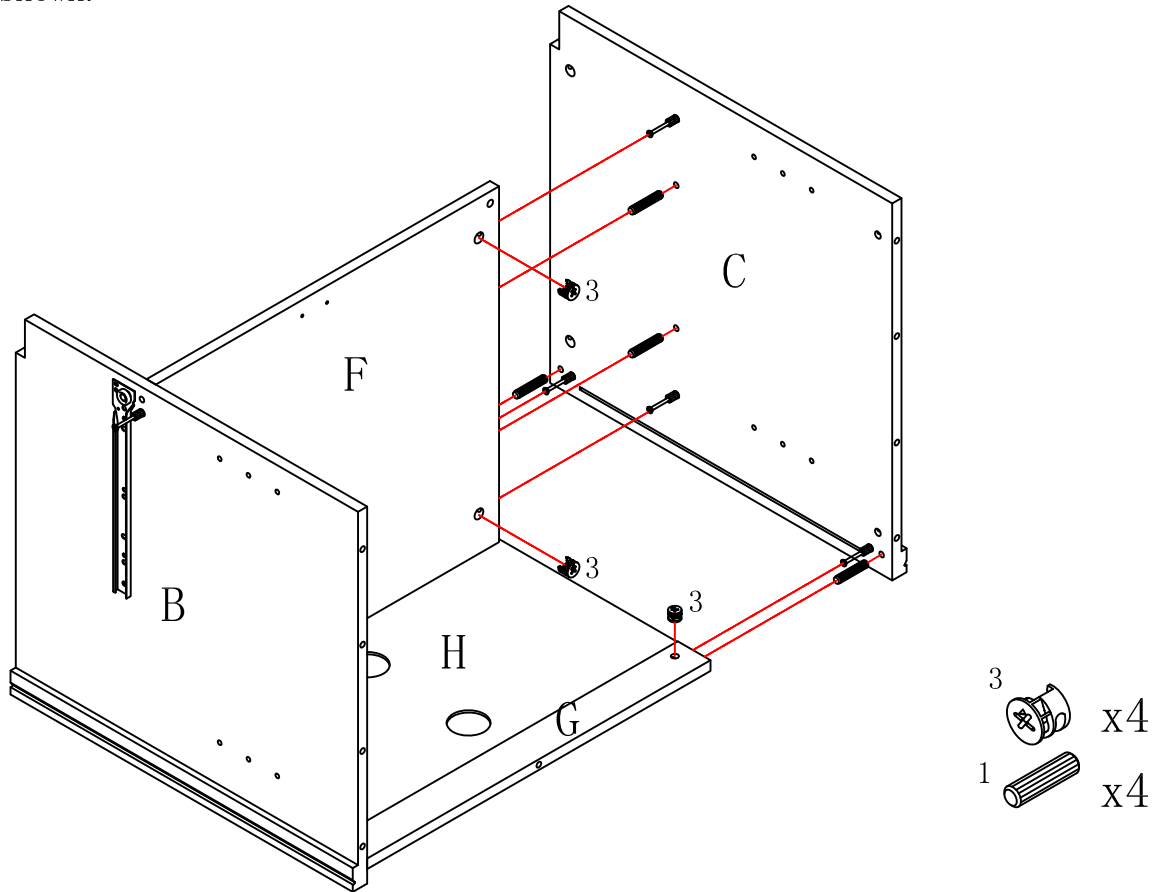

Step 4. Carefully turn assembled parts G, C, F, H & B upright with notched cutouts facing upward. Attach Rail I using Long Screw (part#12) & Wood Dowel (Part#1) as shown.

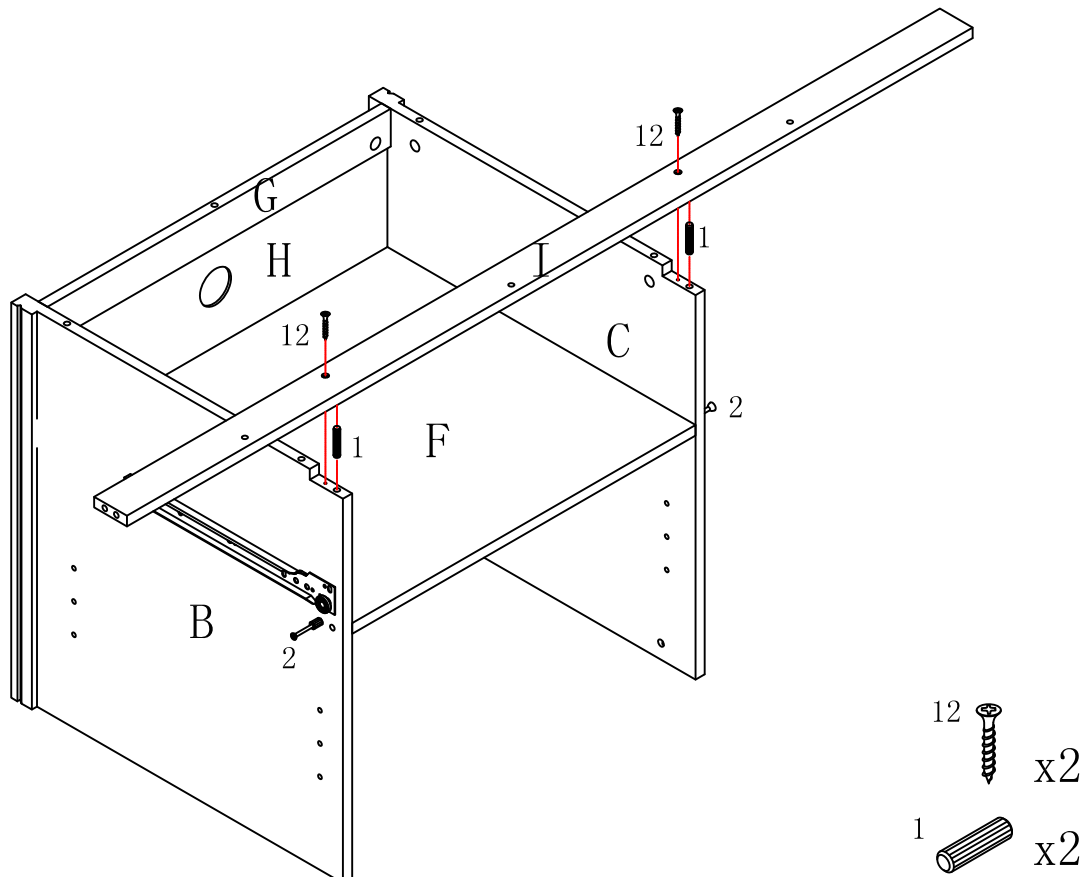

Step 5. Turn unit over with Rail I flat on floor as shown. Attach Rail J to Panel C (Rail K to Panel B) using Cam Lock & Wood Dowel as shown .Attach Side Panel D to Rails K & I (Side Panel E to Rails J & I) using Cam Lock & Wood Dowel as shown. Attach Double Door Magnet (part#8) to shelf F with Round Head Screw (part#10) into pre-drilled holes as shown. Attach Door Magnet (part#9) to Rails J & K with Round Head Screw (part#10) into pre-drilled holes as shown.

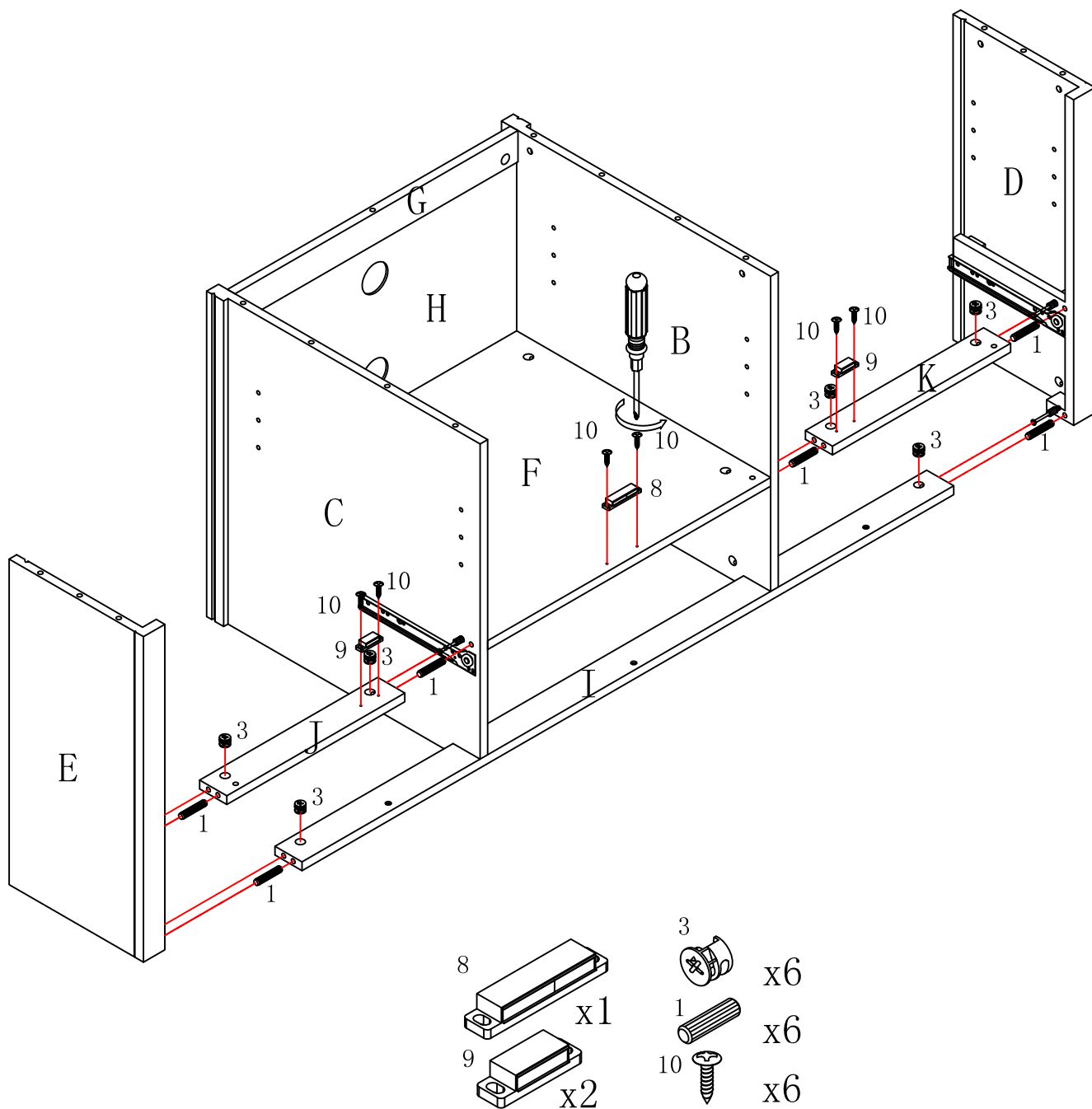

Step 6. Attach Base T to cabinet using Wood Dowel (Part#1), Hex Docket Head Bolt (part#4) & Barrel Nut (part#5). Insert Adjustable Levelers (part#14) into pre-drilled holes. Attach 2 Support Legs Z under the Bottom Panel T. Carefully turn cabinet with Adjustable Levelers on the floor as shown.

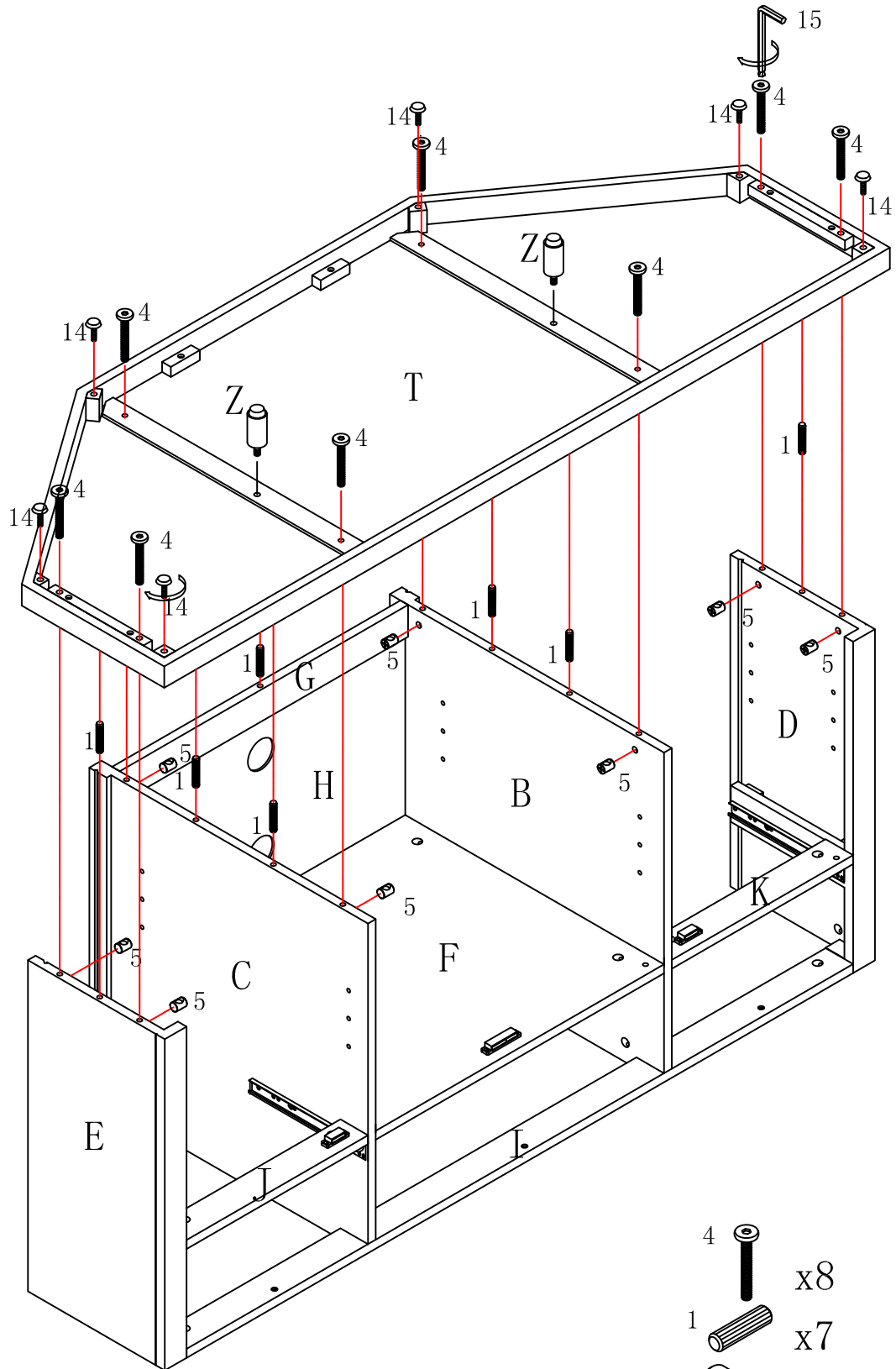

Step 7. Slide Back Panel L into the grooves as shown. Attach Top A to cabinet using Wood Dowel & Cam Lock as shown..Secure Rail I to Top A using Long Screw (part#12) through pre-drilled holes as shown.

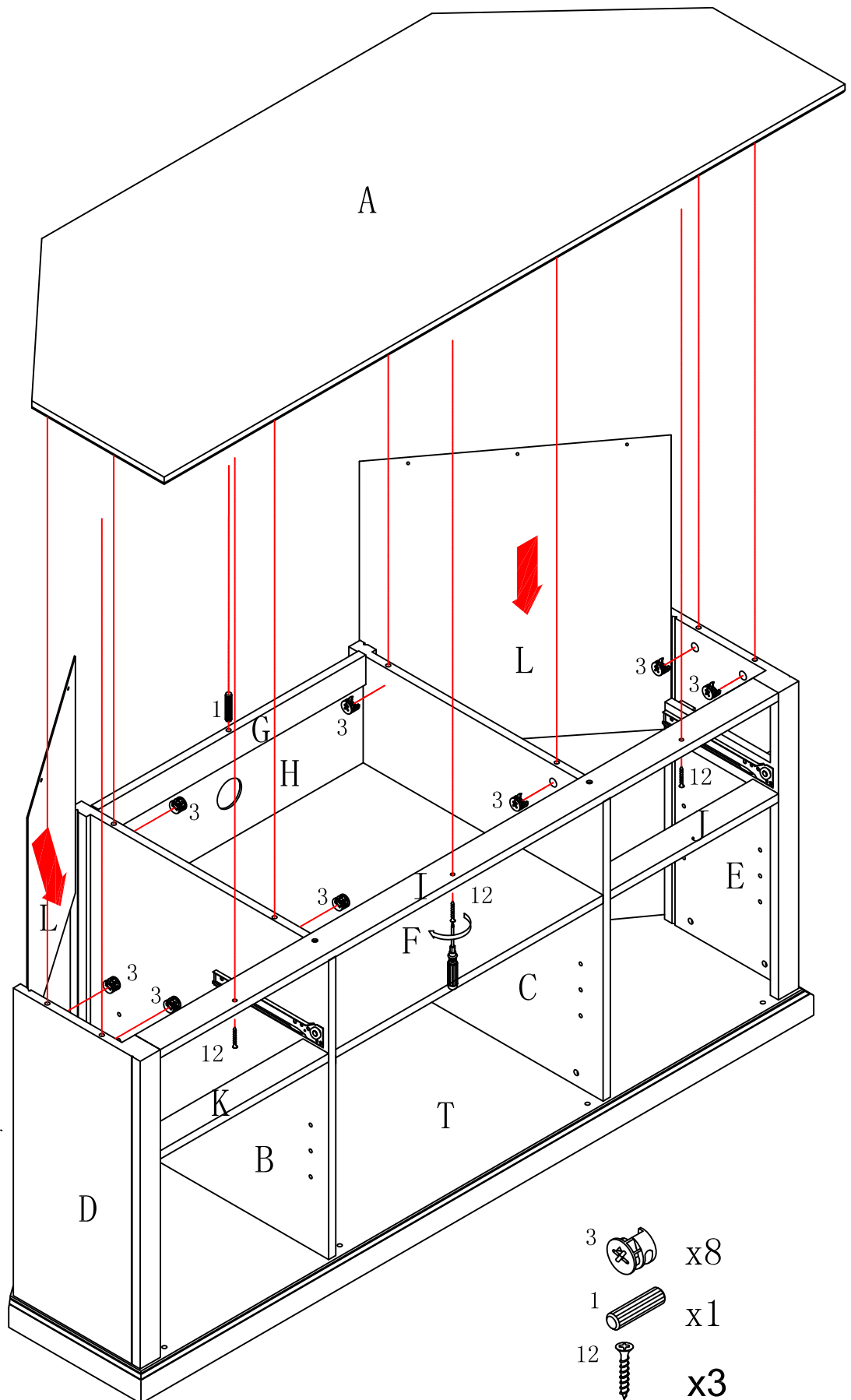

Step 8. Attach Panels L to Top A with Round Head Screw (part#10) as shown.

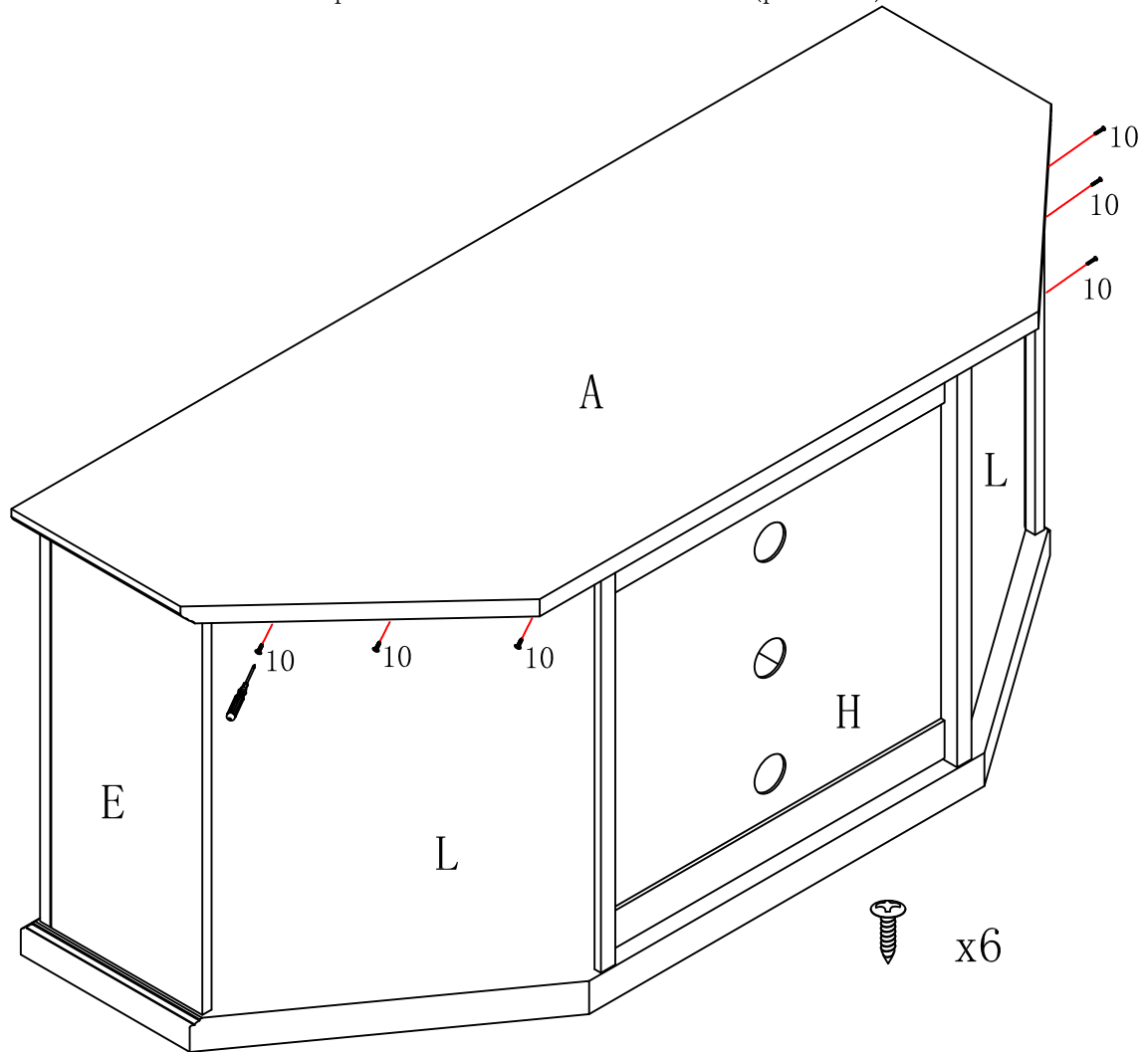

Step 9. Attach Drawer Front U to Drawer Sides W & V with Short Screw (Part#11) using Phillips Head screw driver as shown. **NOTE: BE SURE THAT THE WHEELS ON DRAWER GLIDES ARE FACING OUTWARD, AND ARE AT THE OPPOSITE SIDE OF THE DRAWER FRONT.** Slide Bottom Panel X into the grooves of Parts V & W as shown. Attach Back Panel Y to Side Panels V & W with Short Screw (part#11) using Phillips head screw driver as shown. Repeat this step for the other drawers. Attach Hardware Knobs (Part#6) to Drawer Fronts U with Round Head Bolt (Part#7) as shown.

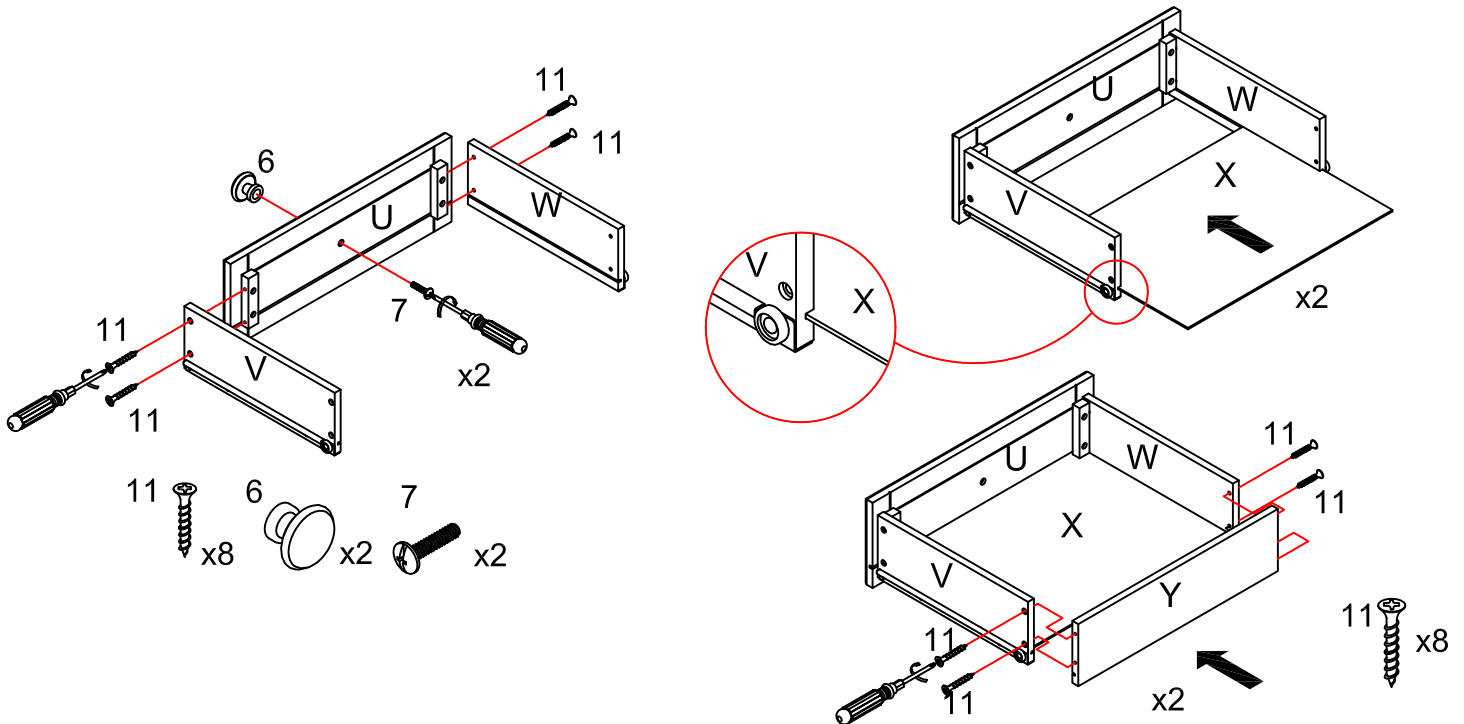

Step 10. Attach Hardware Knobs (Part#6) to Doors M, N, O & P using Round Head Bolts (part#7) & Phillips head screw driver as shown. Attach doors to cabinet by placing bottom Pin Hinge into pre-drilled holes in Base T & depressing top spring loaded Pin Hinge to fit door into place in Parts K, F & J. NOTE: Be Sure Pin Hinges (top & bottom) have fully extended into the pre-drilled holes in Base T and Parts K, F & J to secure doors into place.

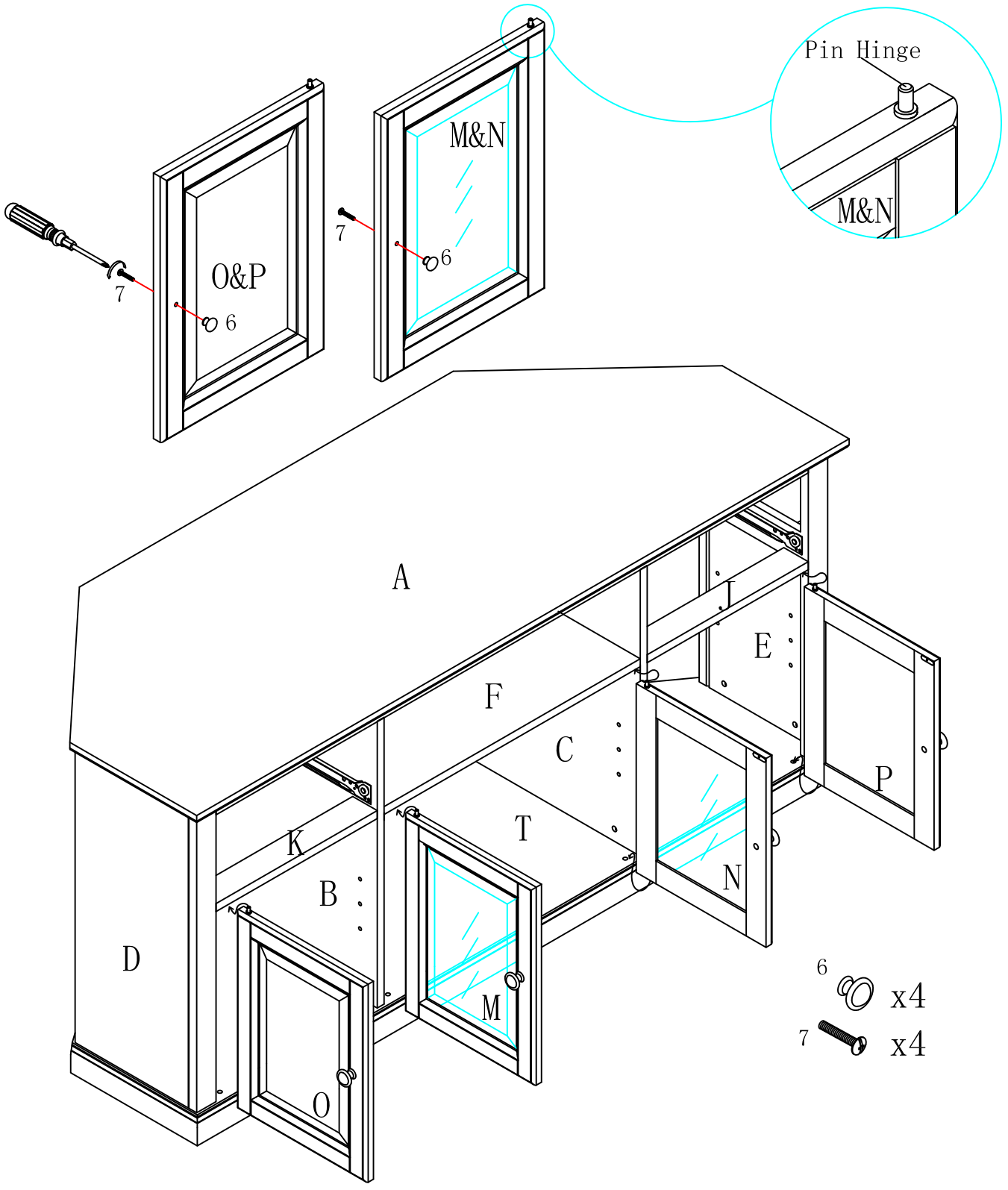

Step 11. Insert the Shelf Holders (part#13) into desired position. Insert drawers and shelves into cabinet as shown.

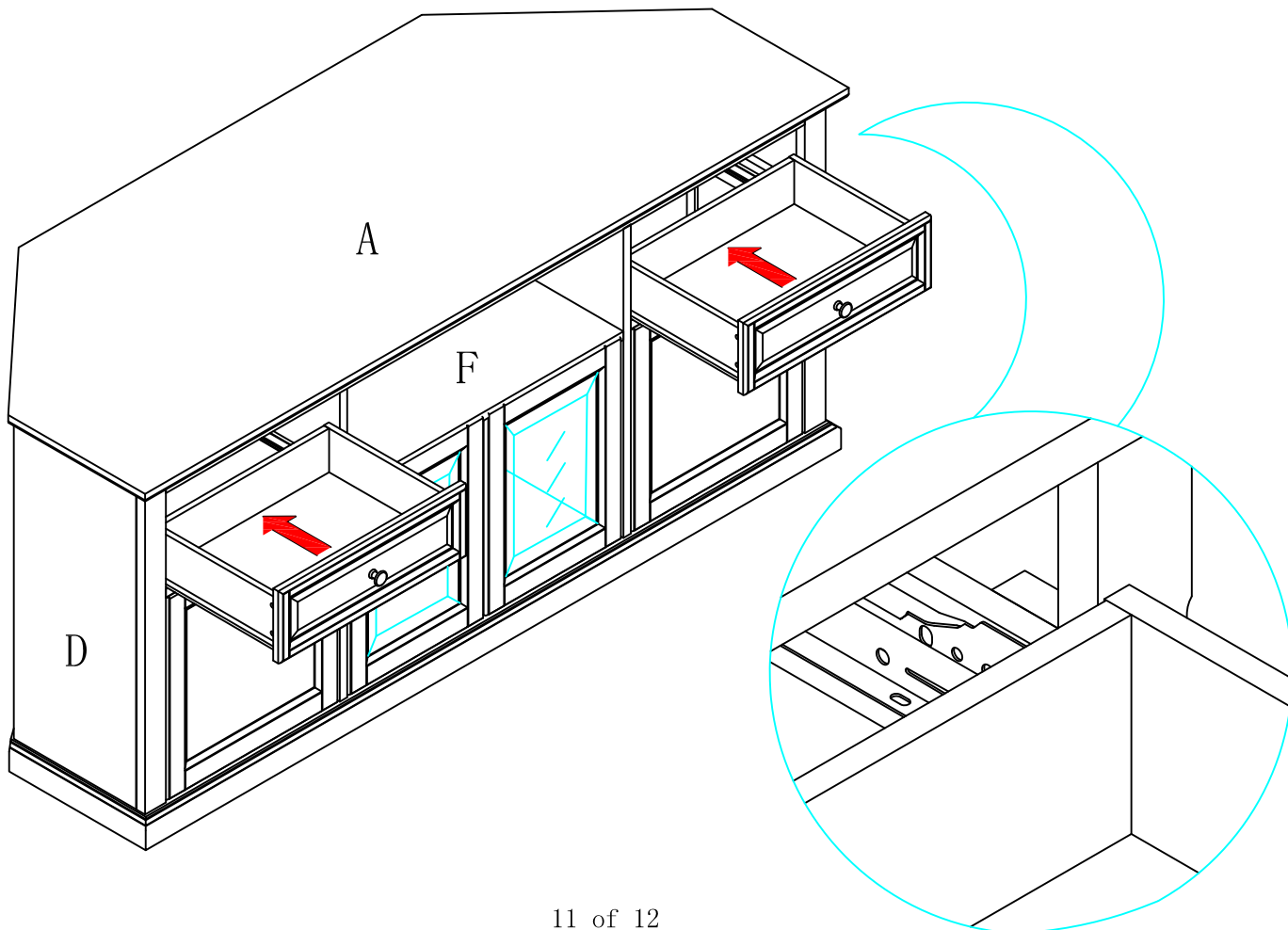
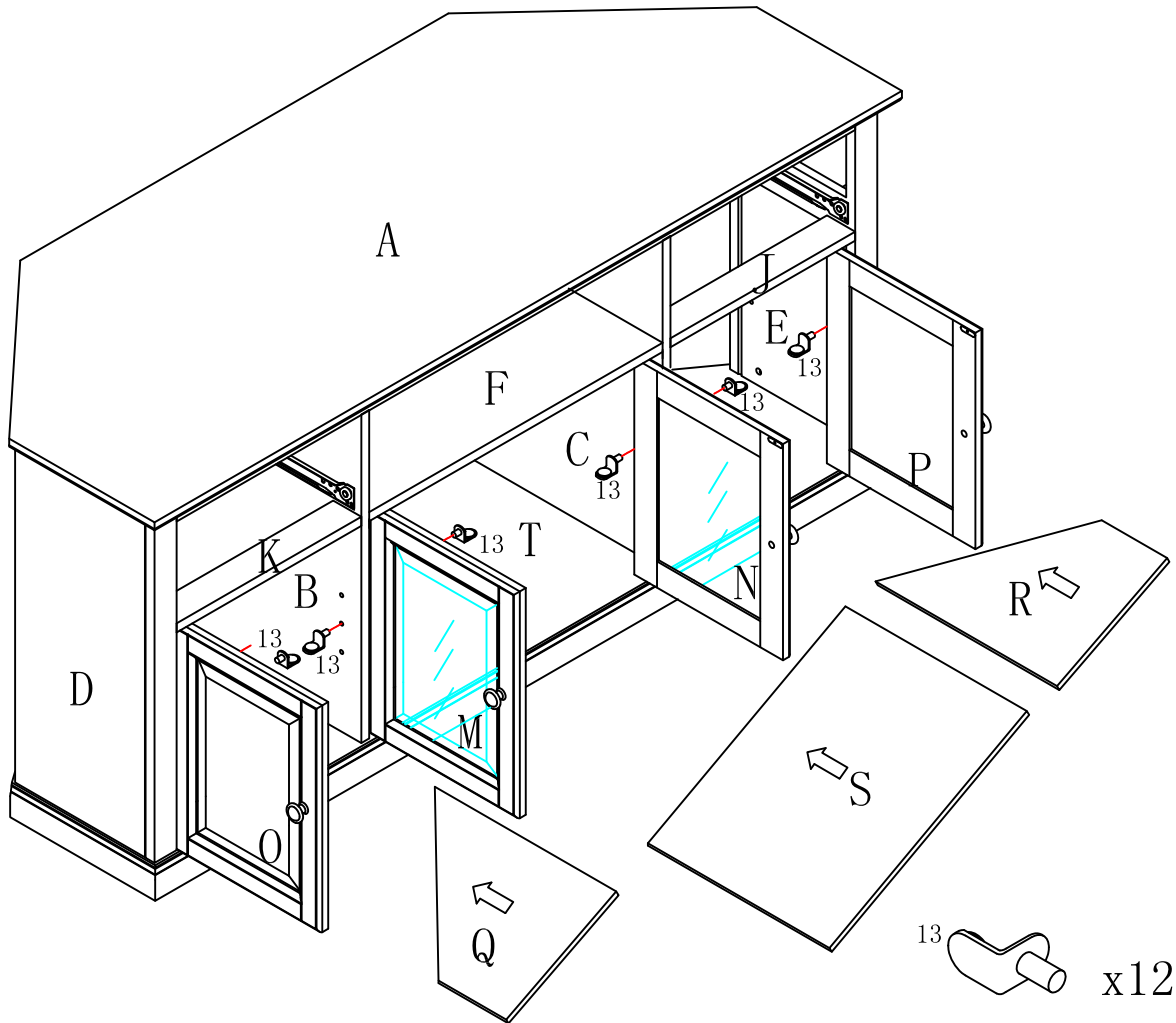

Limited Manufacturers Warranty

Our products are warranted against defects in material and workmanship for a period of 90 days beginning from the date of sale.

Should you experience any damaged, defective, or missing parts, or need help with assembly, please call us directly before contacting the retailer.