

Installation Instruction

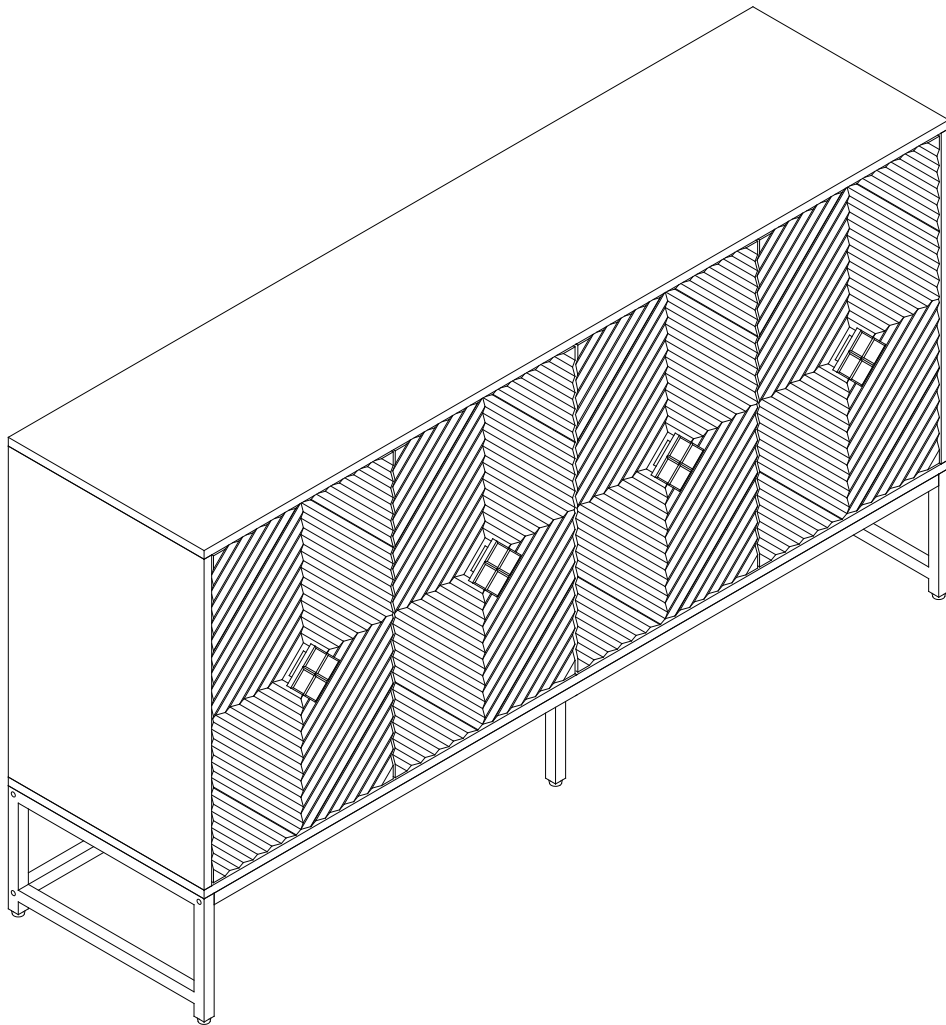

Product name

4 Door Cabinet

Ver.1.0 20240308

Assembling

What you need

- Use the packaging carton as a working surface to prevent product damage during assembly
- Phillips head screwdriver

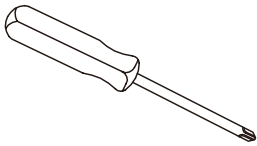

Weight Limitation



40 | **20**
lbs table top | lbs per shelf



2 PERSONS

What 's included

Code	Description	Qty
A	Cam Bolt M6X35MM	18
B	Cam Lock 15X10MM	18
C	Wooden Dowel M6X30MM	14
D	Screw M4X35MM	10
E	Screw M4x14MM	48
F	Large Hinge	4
G	Wood Handle	4
H	Bolt M6x30MM	20
I	Allen Key	1
J	Anchor M6X30MM	2
K	Nylon Strap	2
L	Screw M4x14MM	2
M	Plastic Corner Support	16
N	Screw M3x16MM	16
O	Bolt M6x12MM	2
P	Screw M3x12MM	4
Q	Plastic Door Catcher	2
R	Metal Support	8
S	Wooden Dowel M6X50MM	1
T	Middle Hinge	4
U	Screw M4x40MM	2

The Hardwares

A

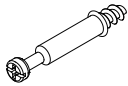

B



C



D

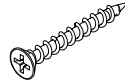

E



F

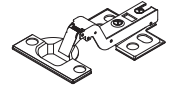

G

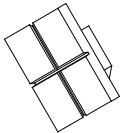

H

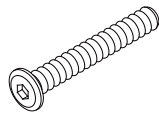

I

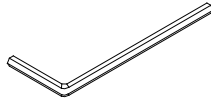

J

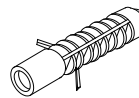

K

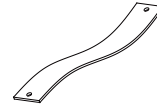

L



M



N



O



P



Q

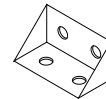

R



S

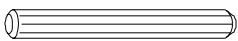

T

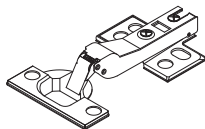

U

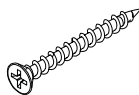

IMPORTANT :

1. Do not tighten bolts / screws completely until all bolts / screws are lined up and inserted into holes.
2. Do not over tighten screws and bolts to avoid stripping.
3. Please use hand tools to assemble this product. Do not use power tools.
4. Must need 2 people to assemble this product.



2 PERSONS

Included Accessories

Code	Description	Qty
1.	Cabinet Top	1
2.	Left Side Panel	1
3.	Middle Division Panel	1
4.	Right Side Panel	1
5.	Vertical Back Stretcher	2
6.	Horizontal Front Stretcher	2
7.	Shelf	2
8.	Bottom Panel	1
9.	Back Panel	2
10.	Side Frame	2
11.	Top Metal Stretcher	2
12.	Bottom Metal Stretcher	1
13.	Middle Support Leg	1
14.	Left Door Of Left Side	1
15.	Right Door Of Left Side	1
16.	Left Door Of Right Side	1
17.	Right Door Of Right Side	1

The Accessories

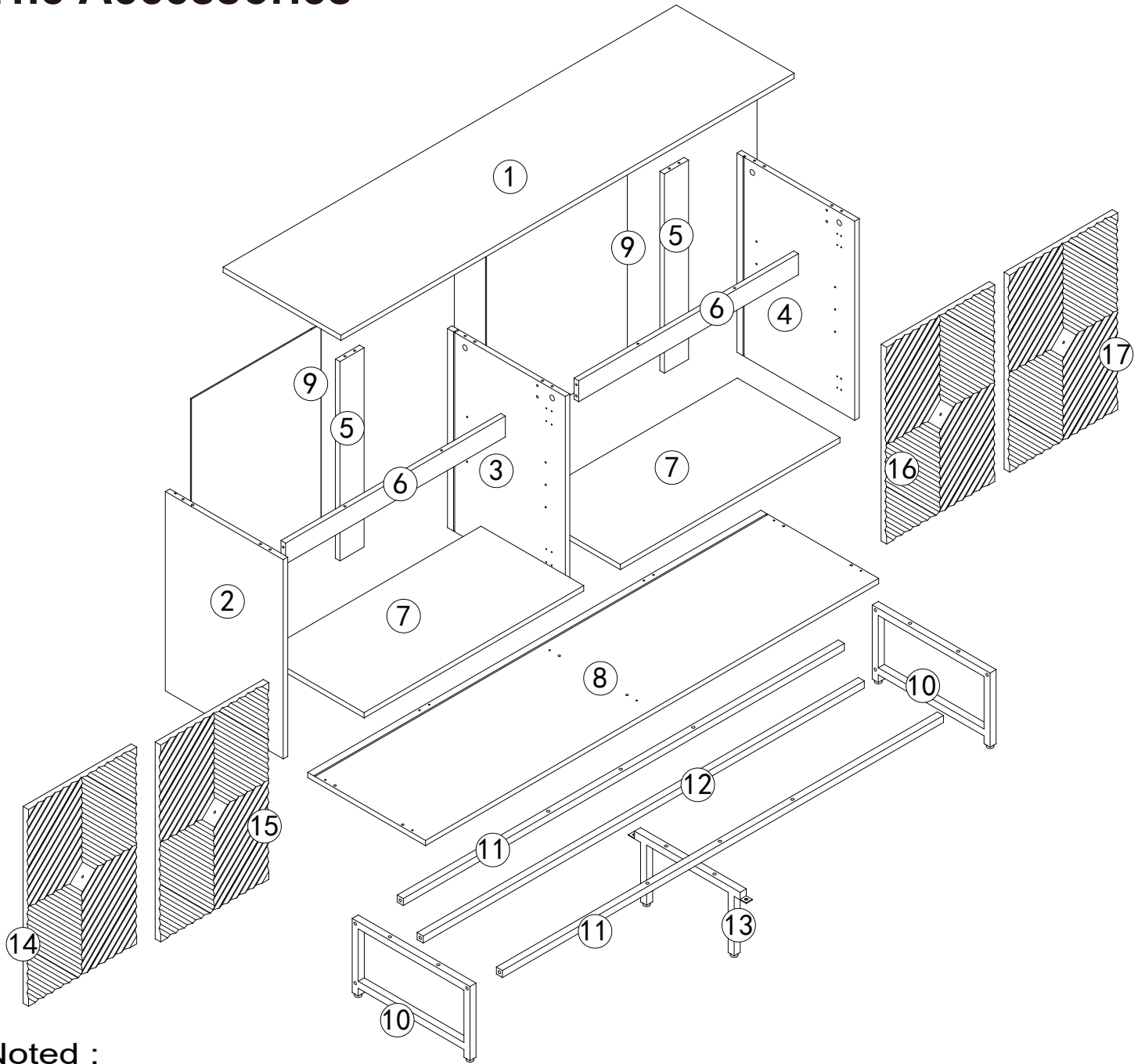

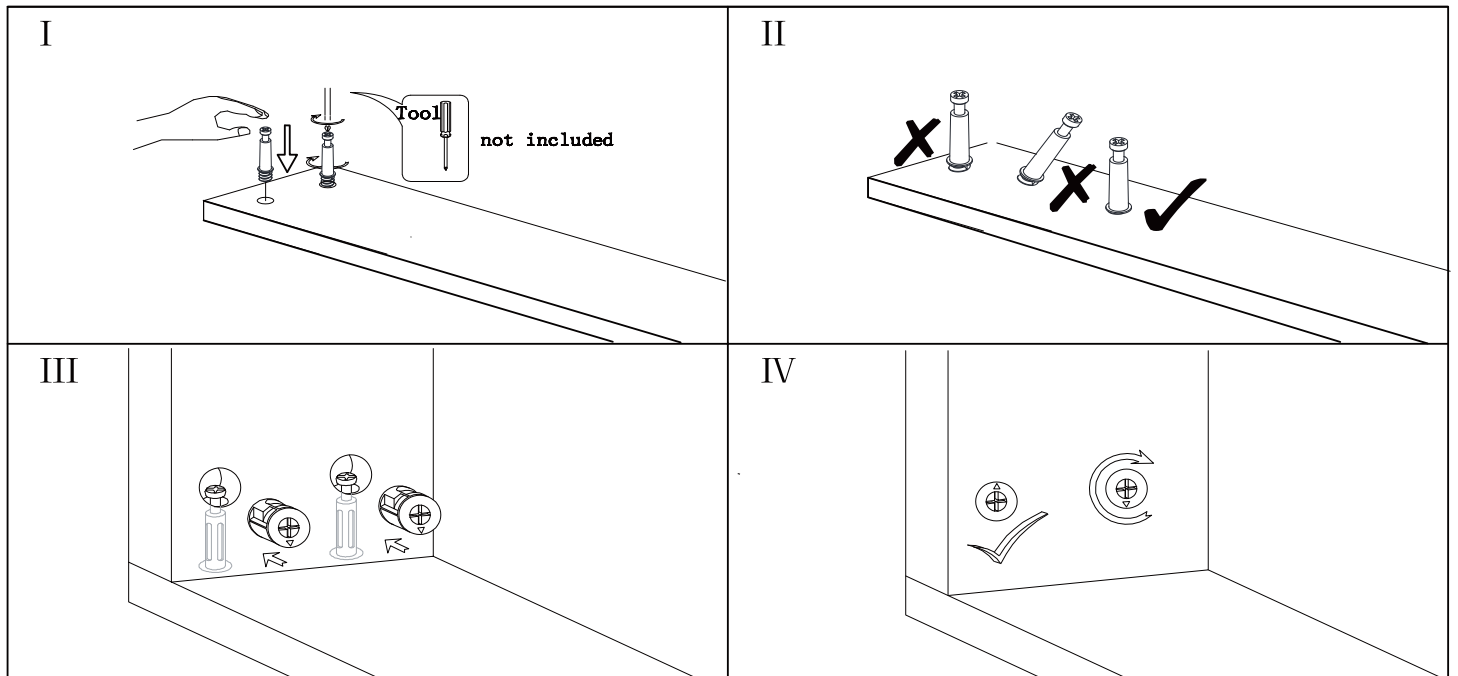

Noted :

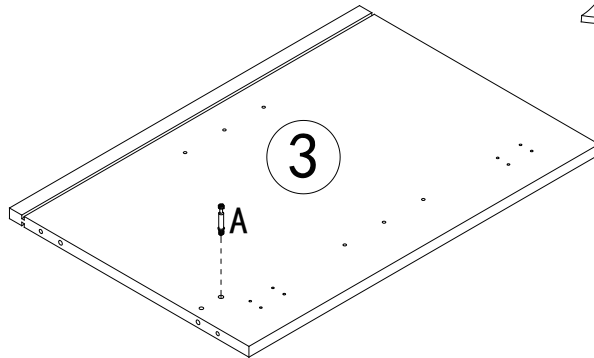
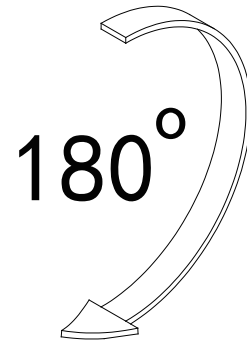
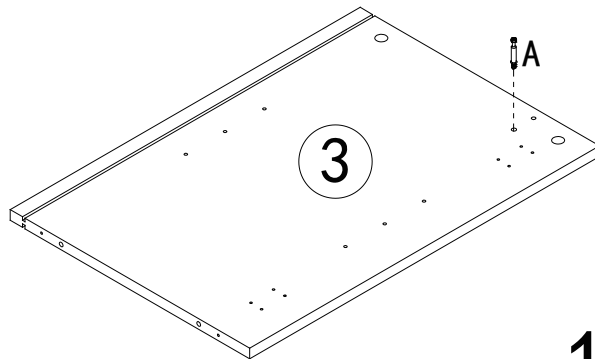
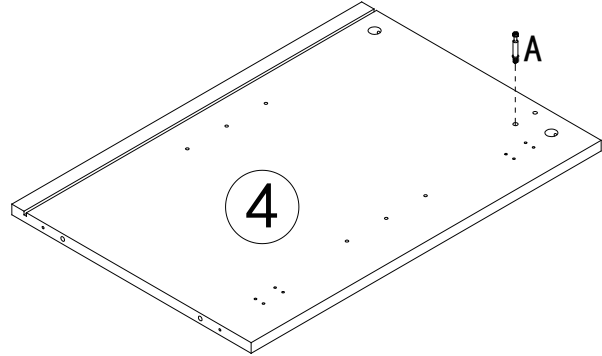
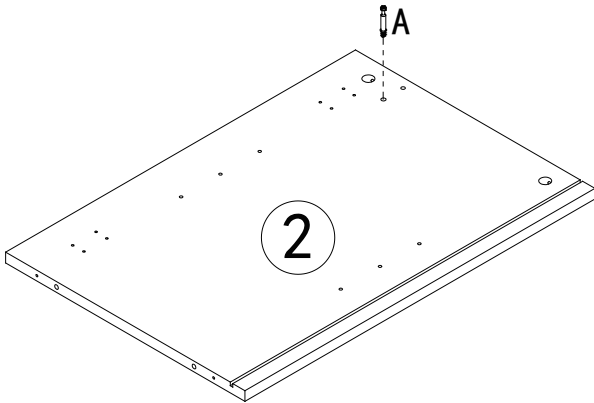
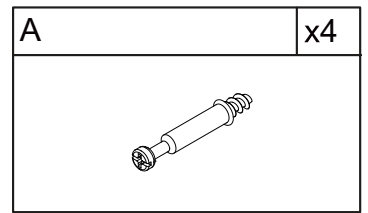

STEP 1

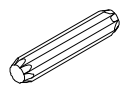

STEP 2

C	x1	S	x1	B	x2
					

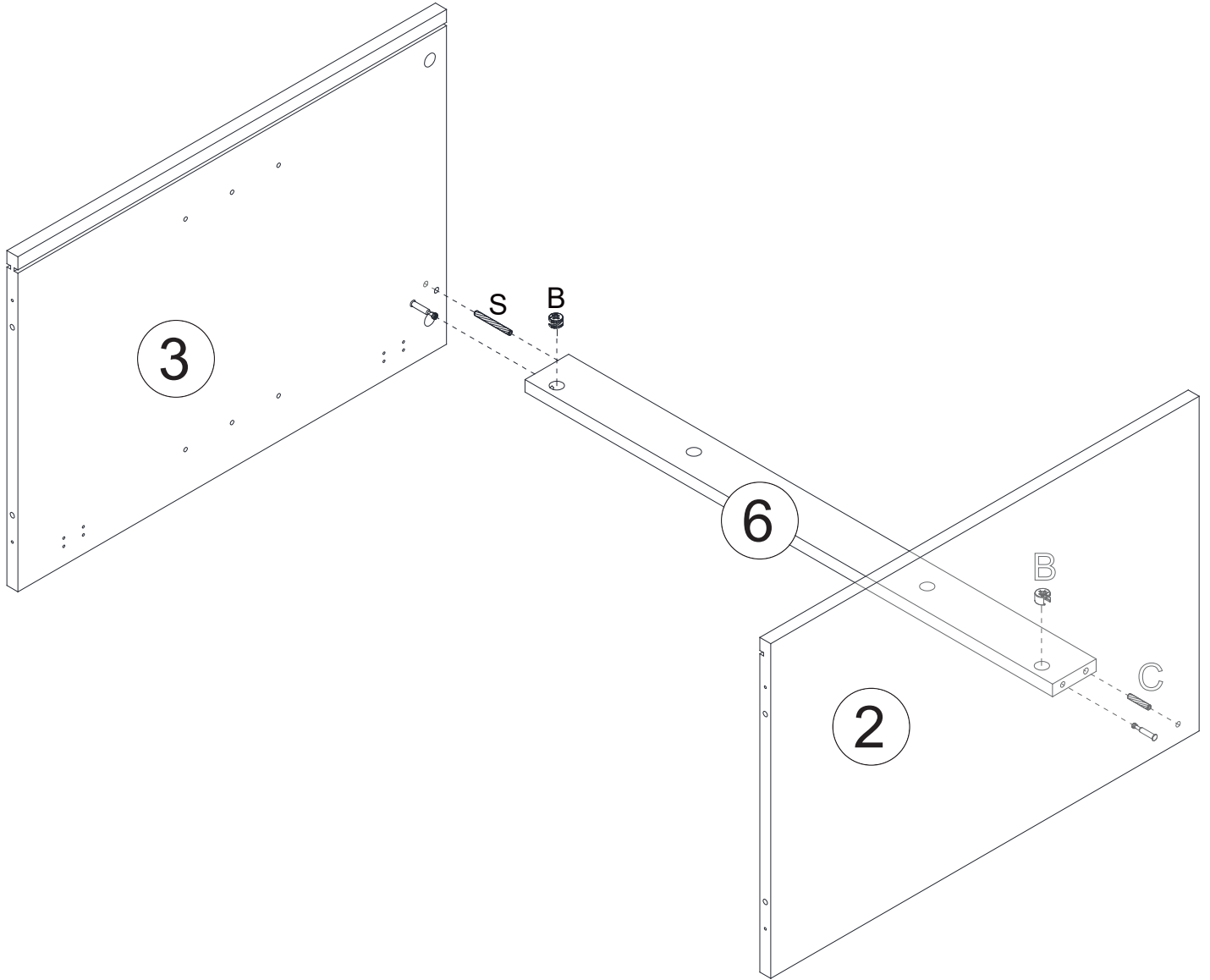

STEP 3

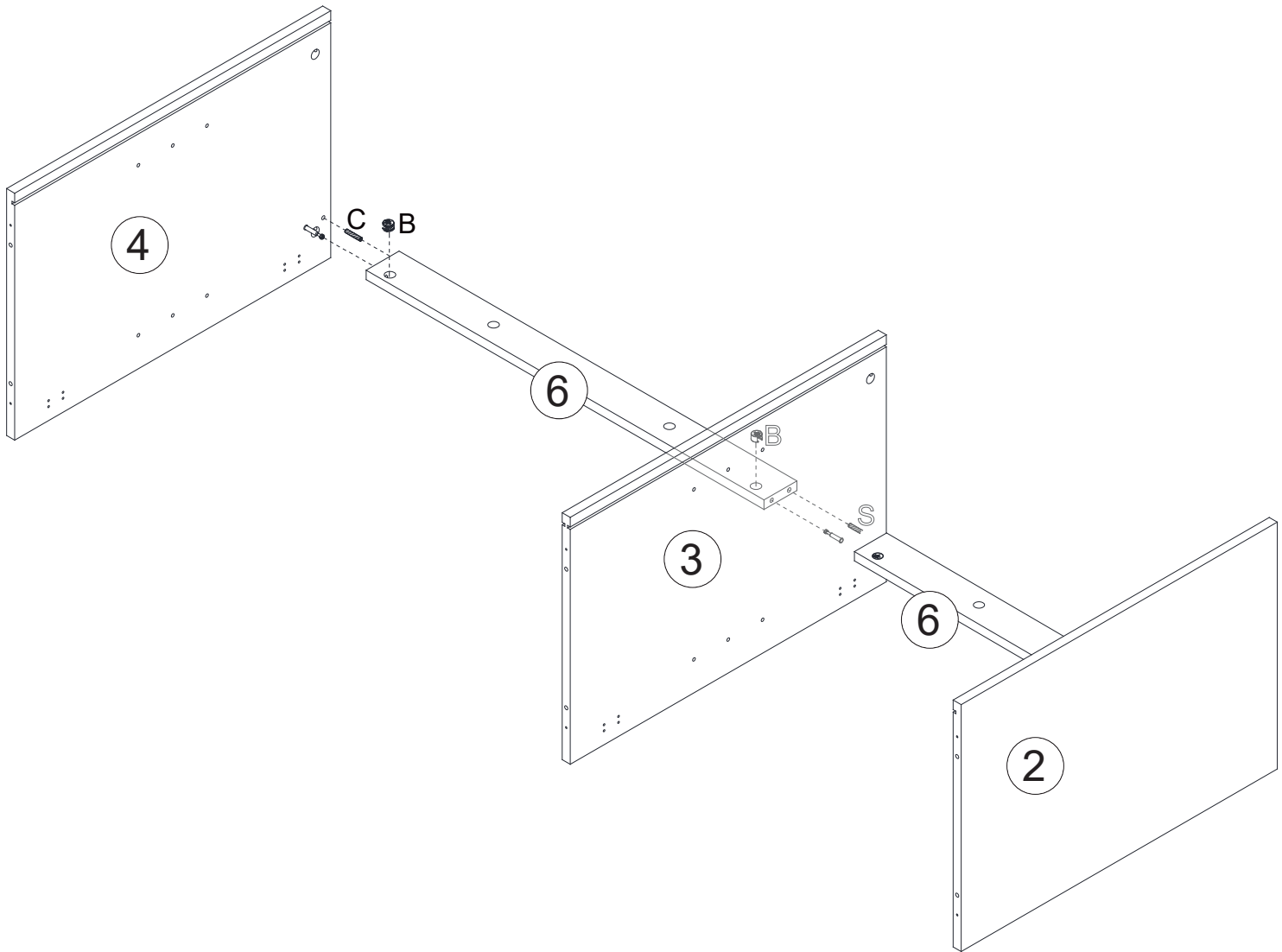
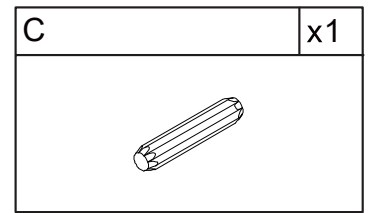
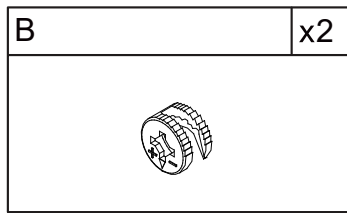

STEP 4

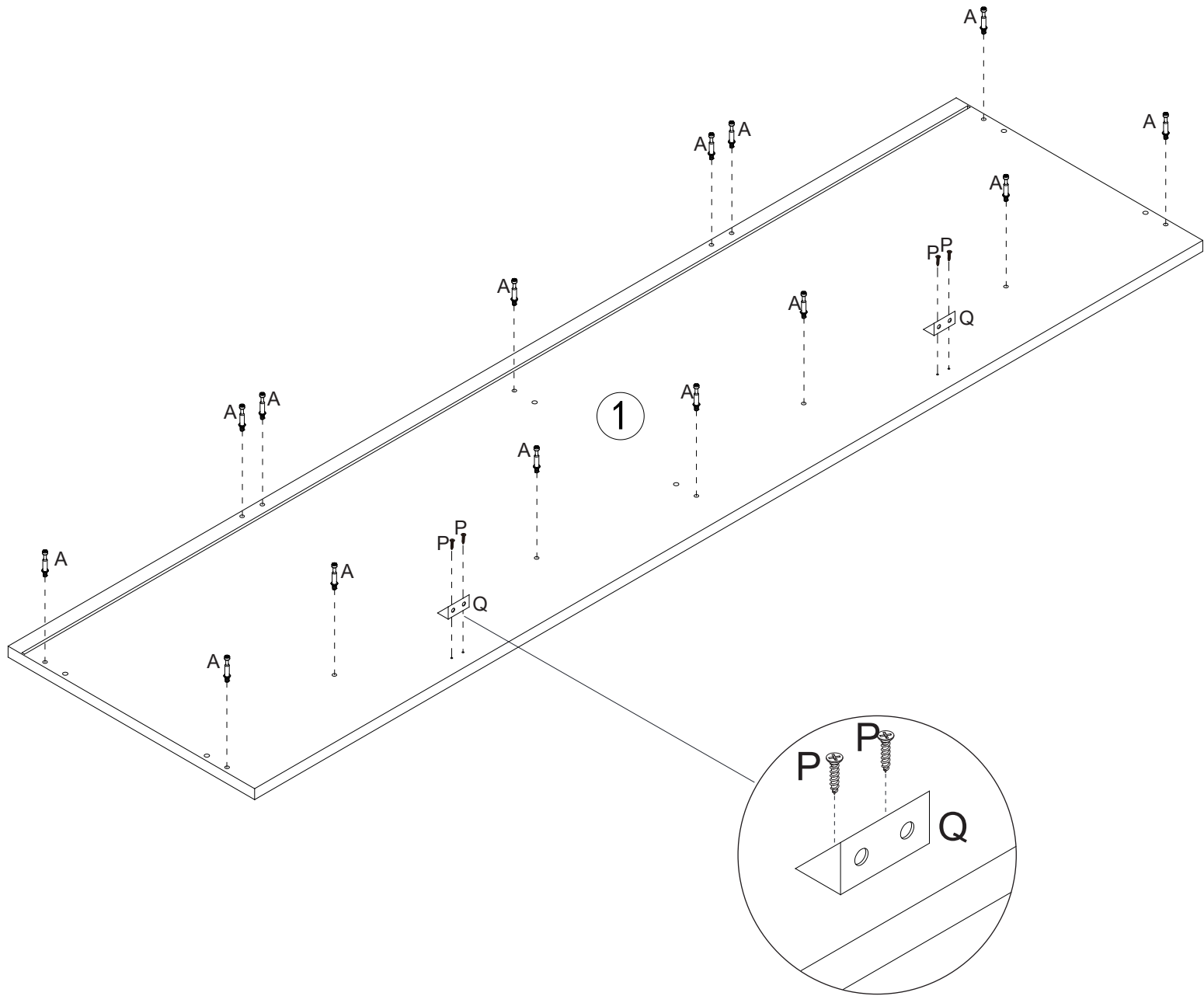
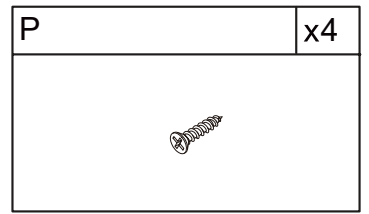
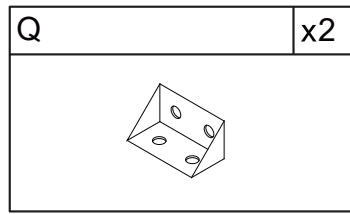
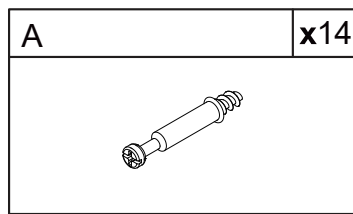

STEP 5

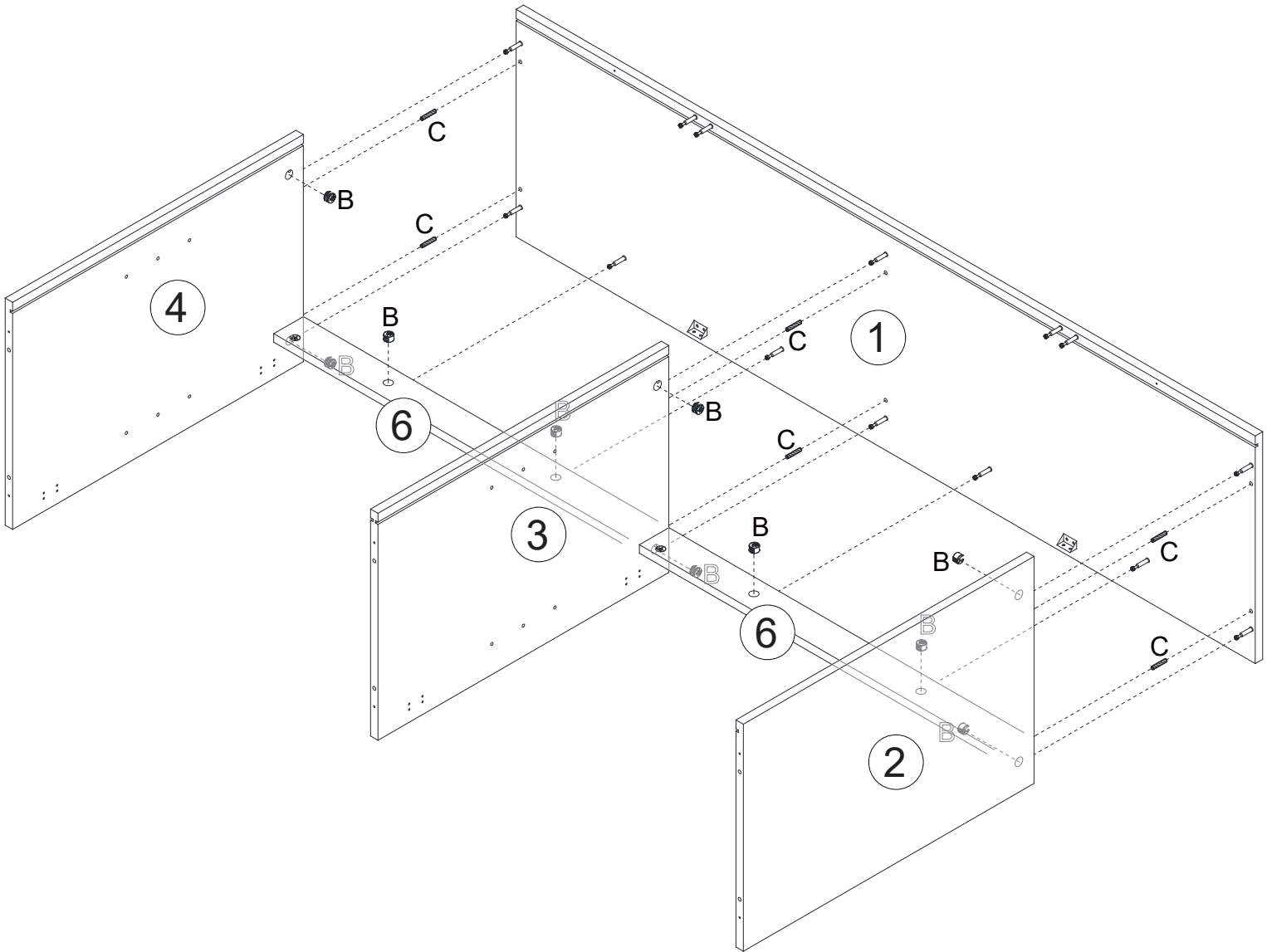
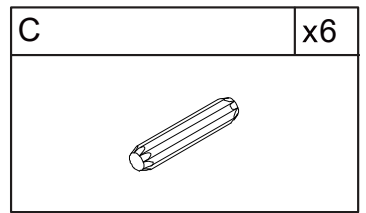
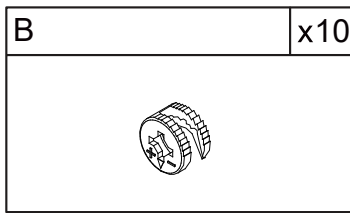

STEP 6

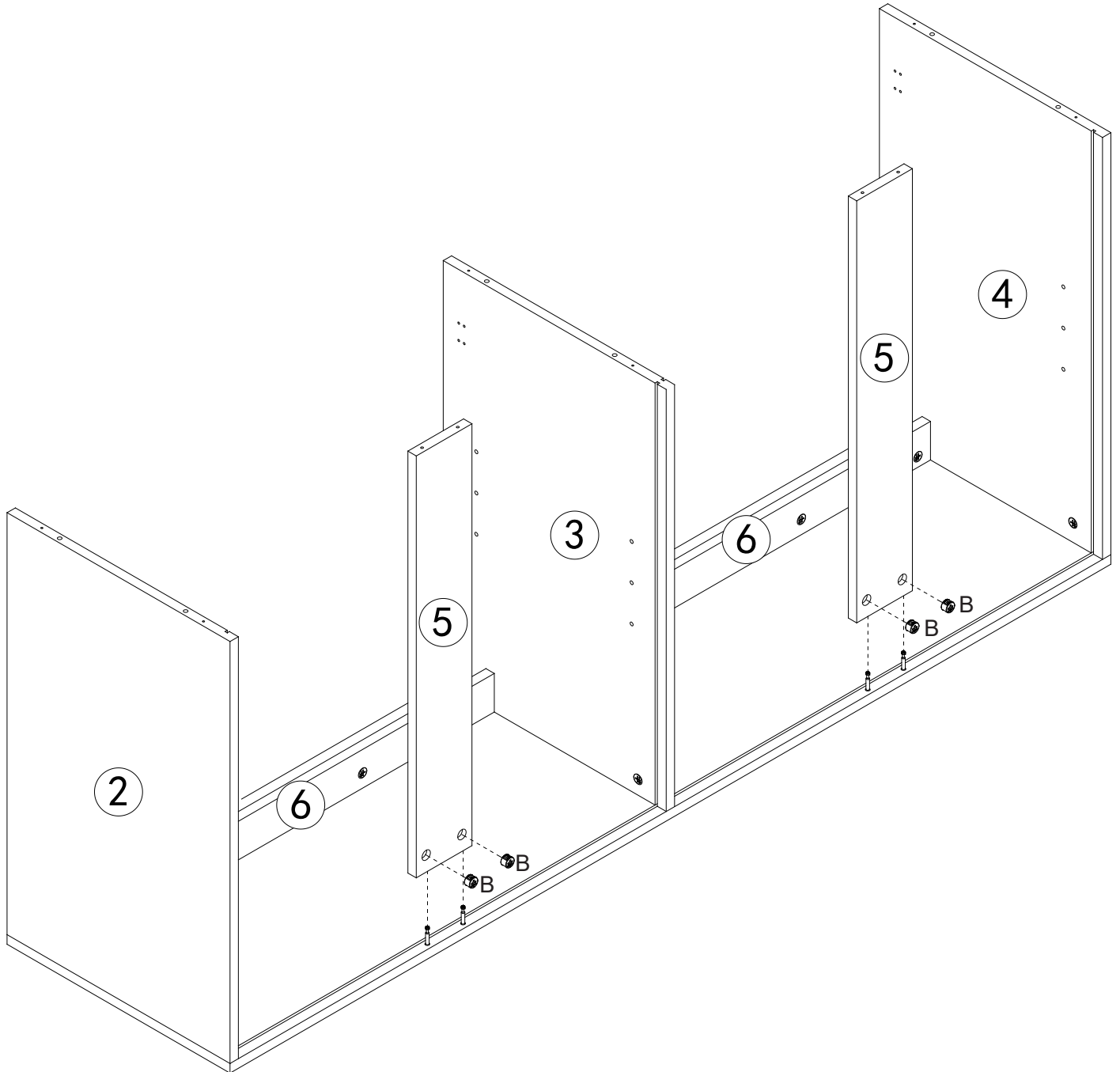
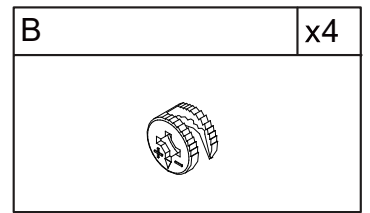

STEP 7

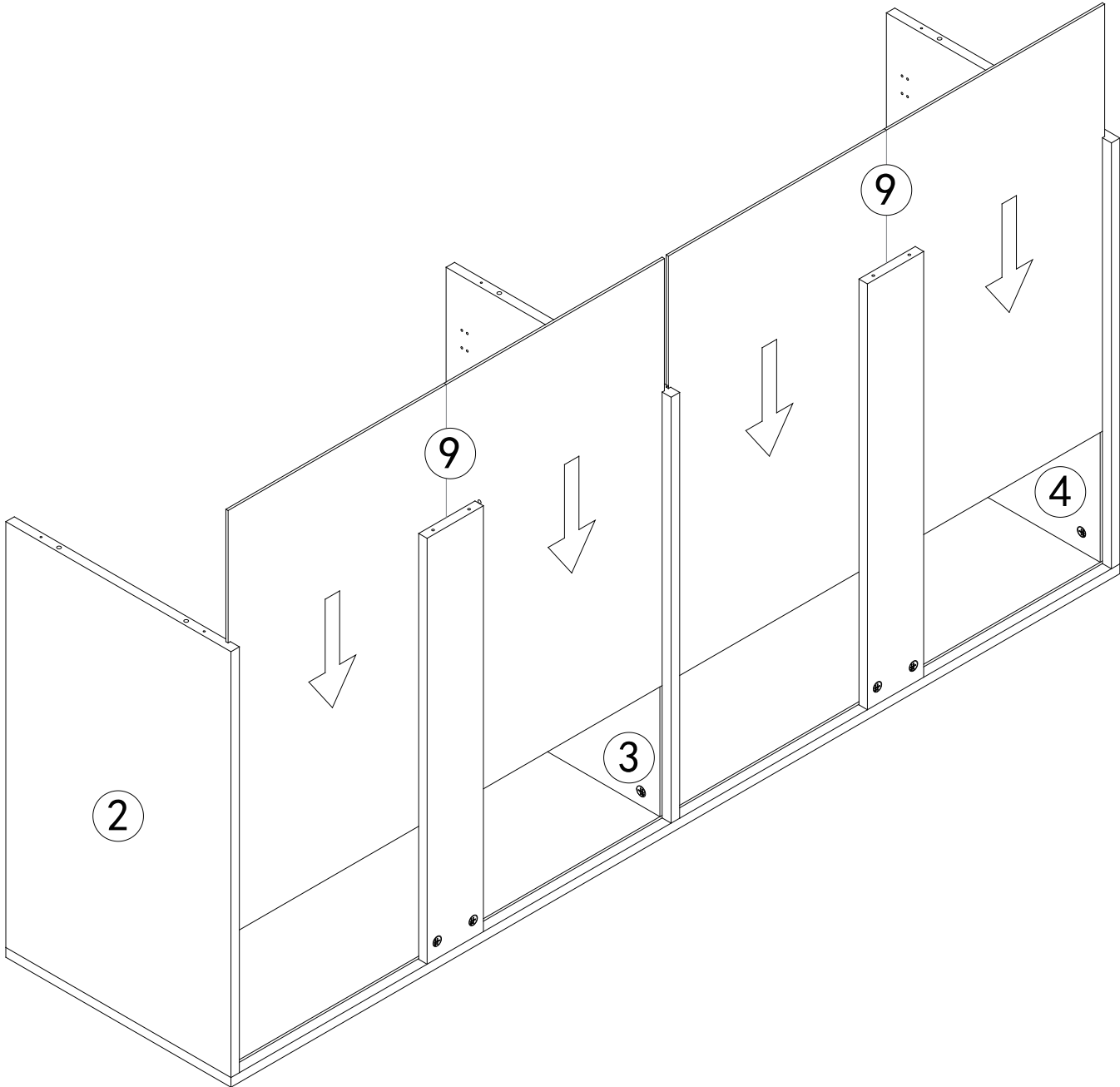

STEP 8

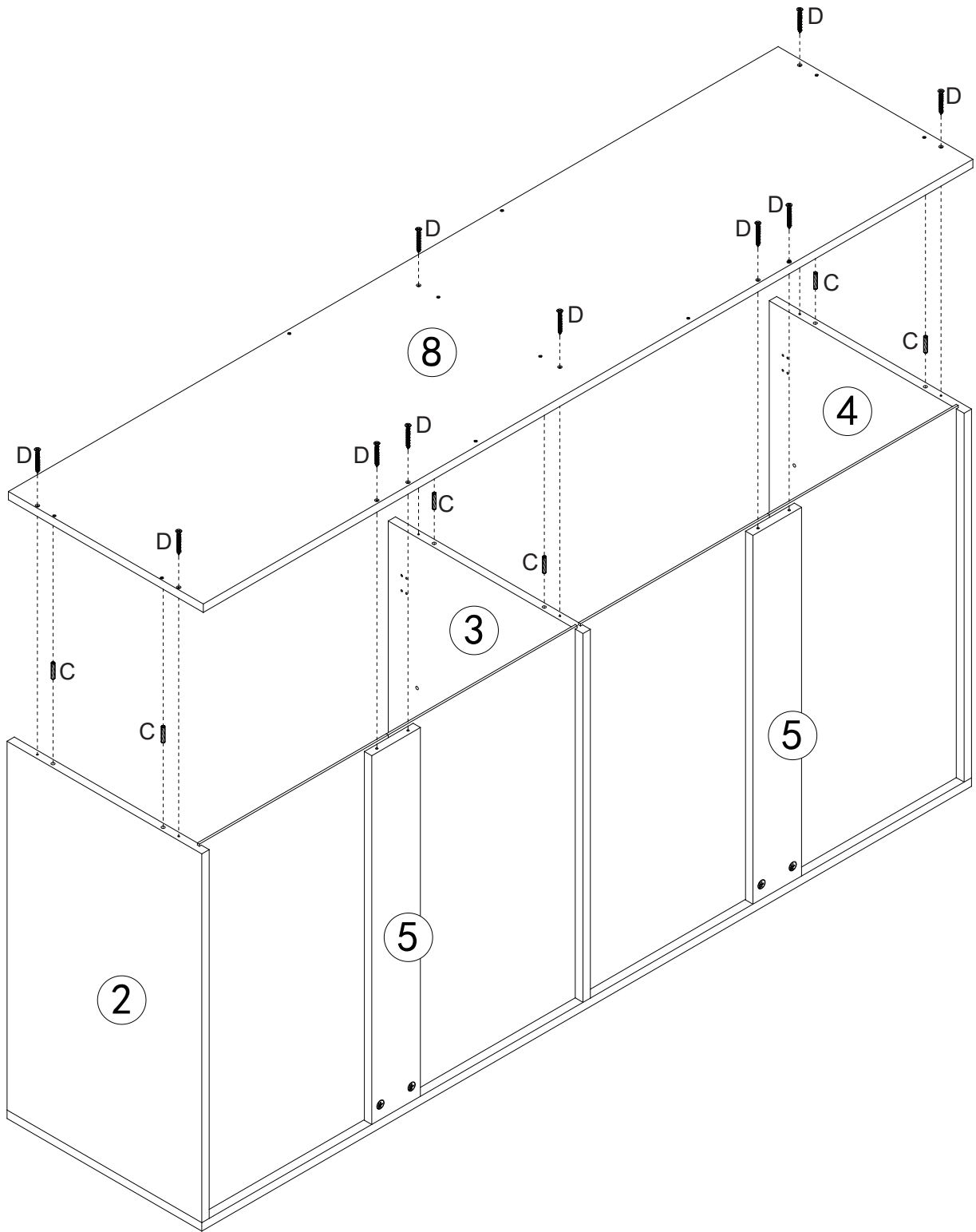
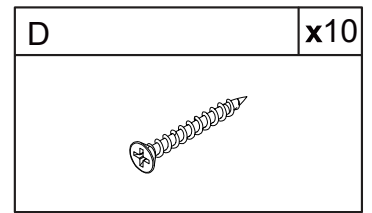
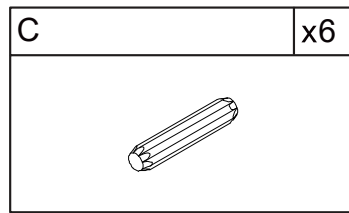

STEP 9

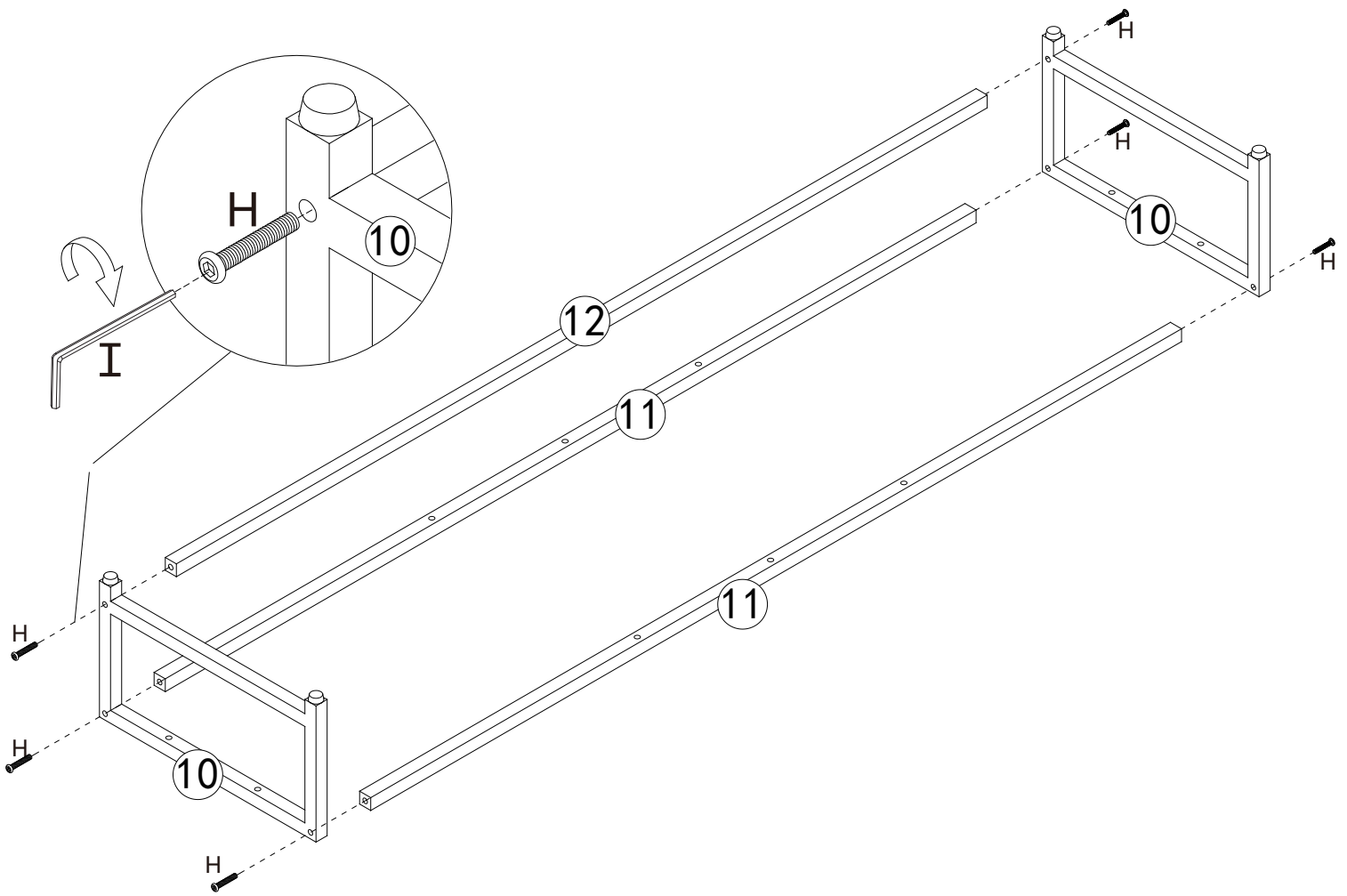
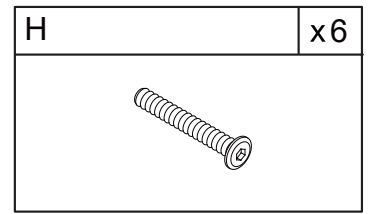
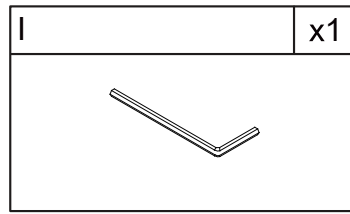

STEP 10

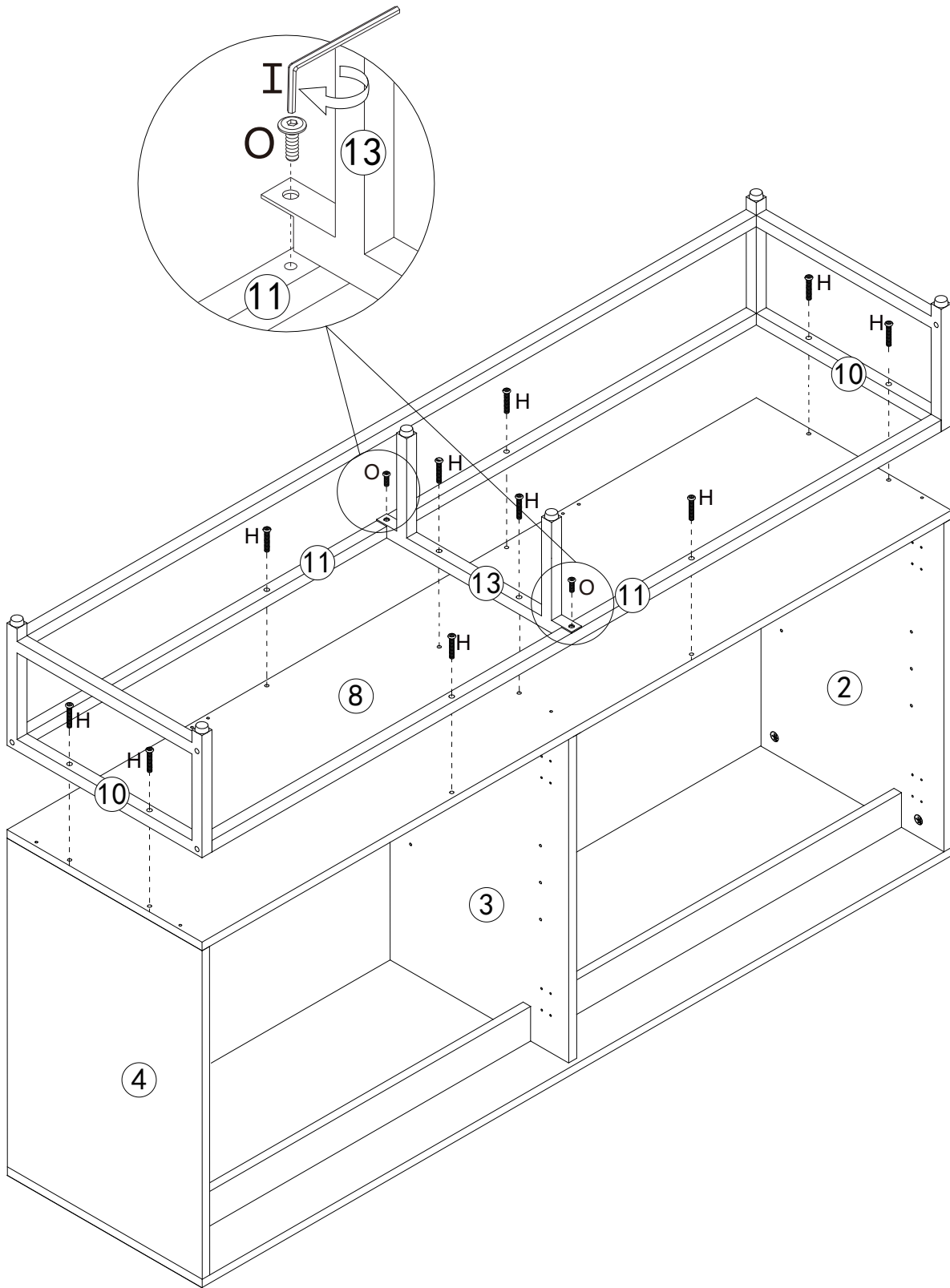
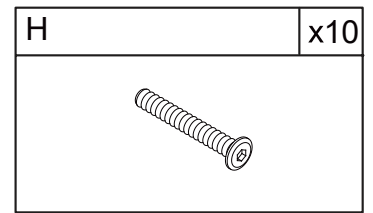
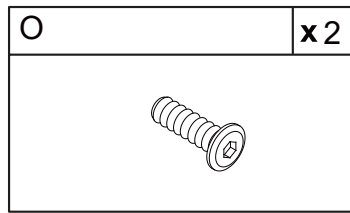
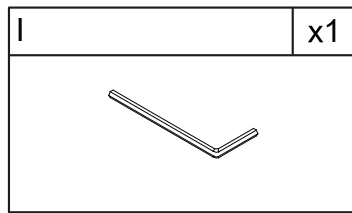

STEP 11

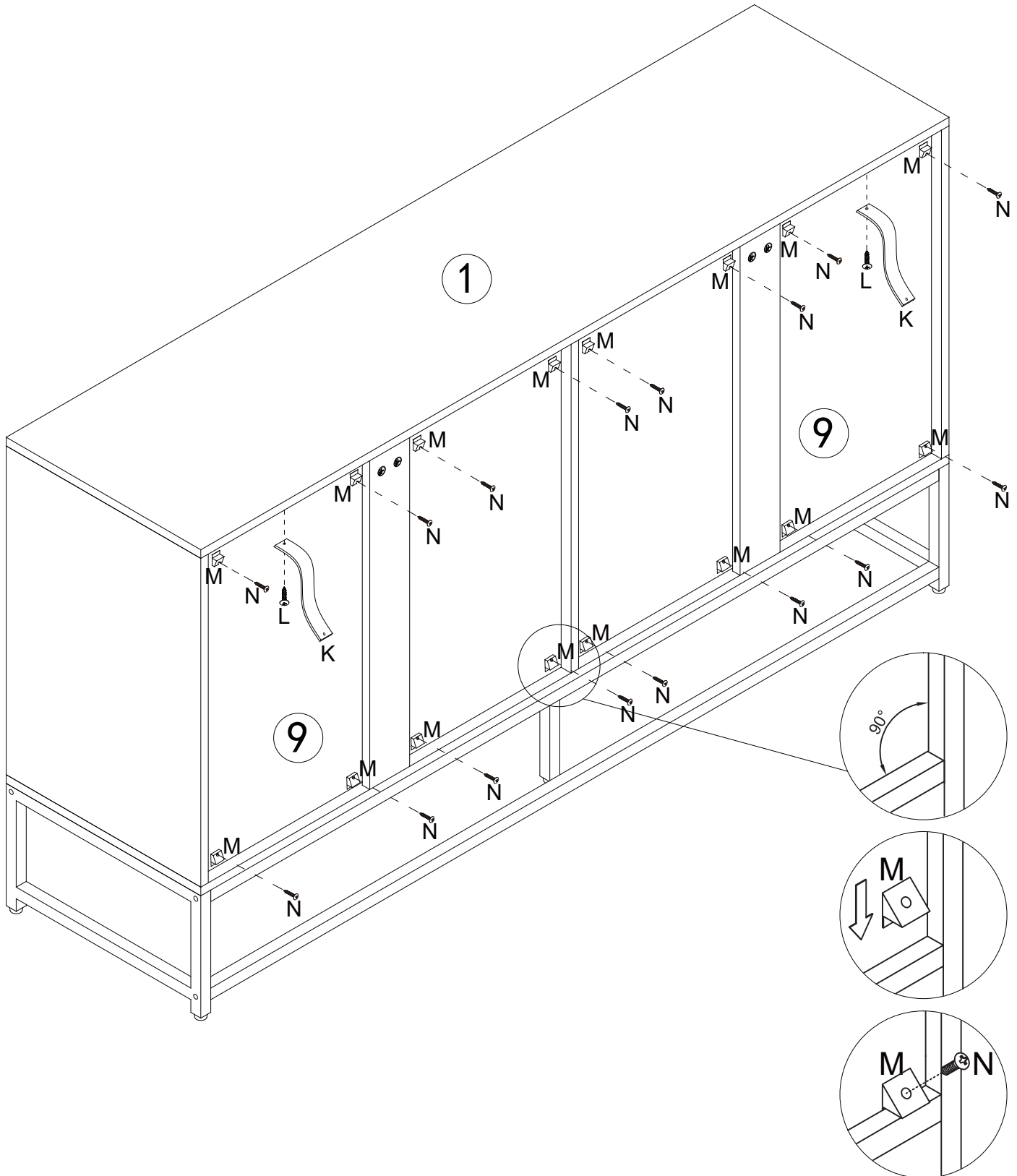
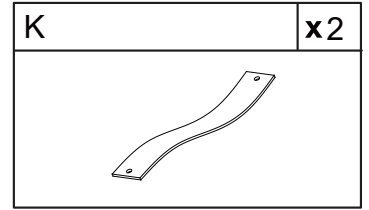
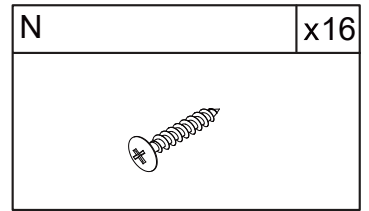
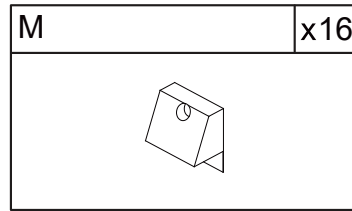
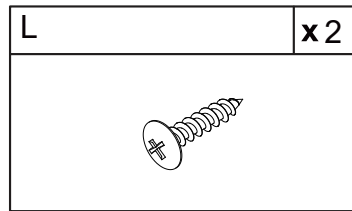

STEP 12

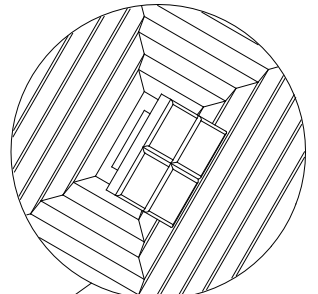
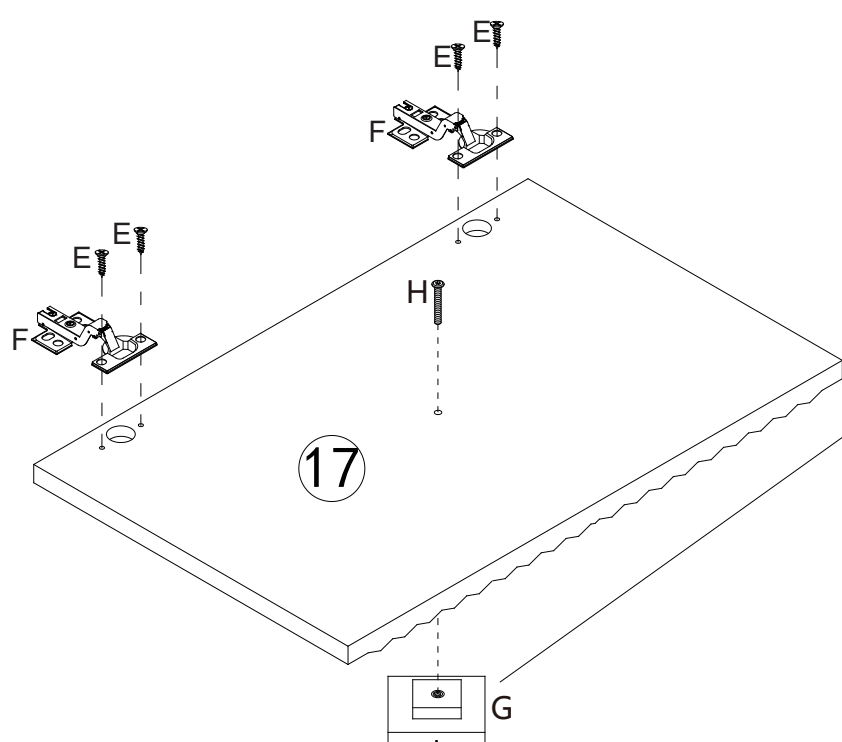
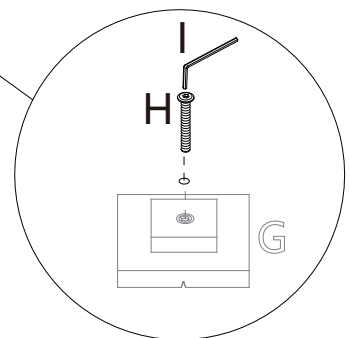
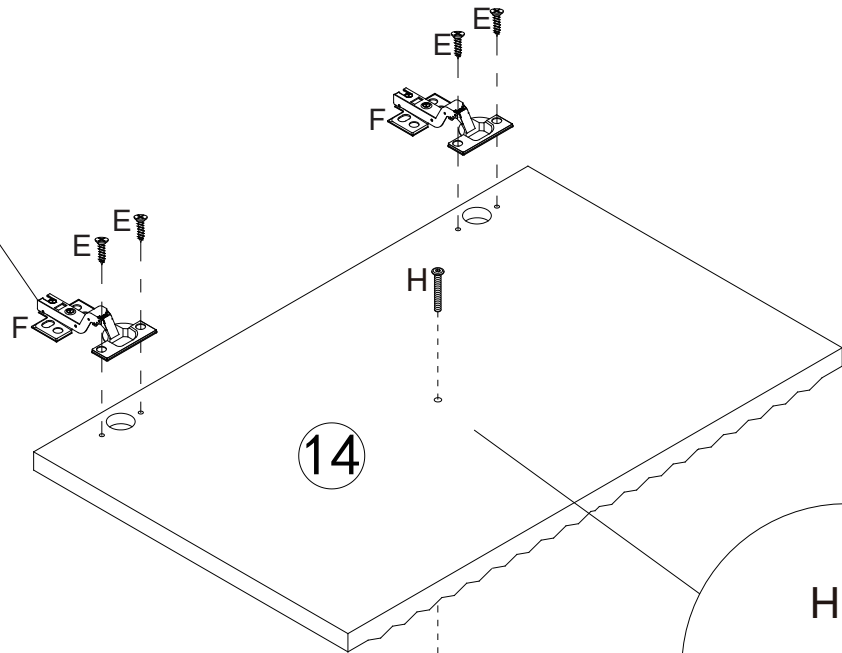
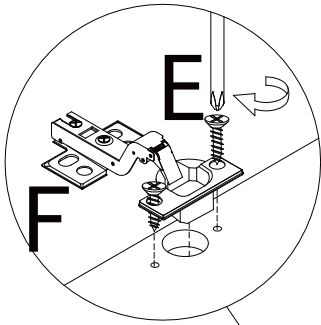
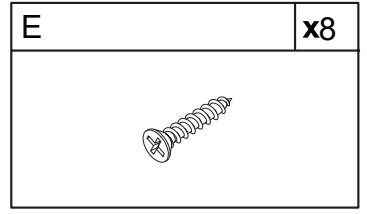
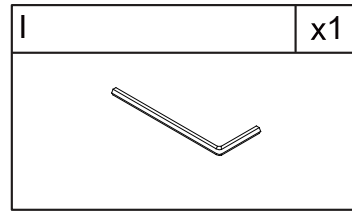
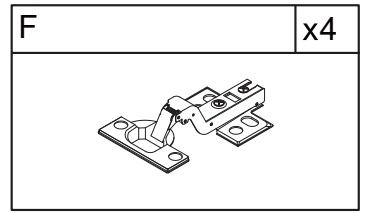
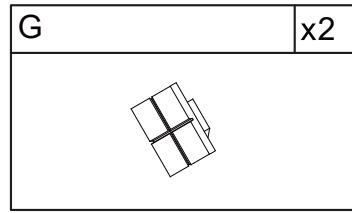
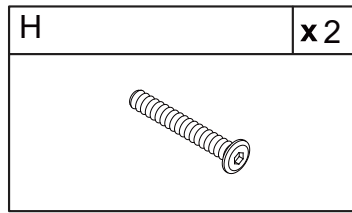

STEP 13

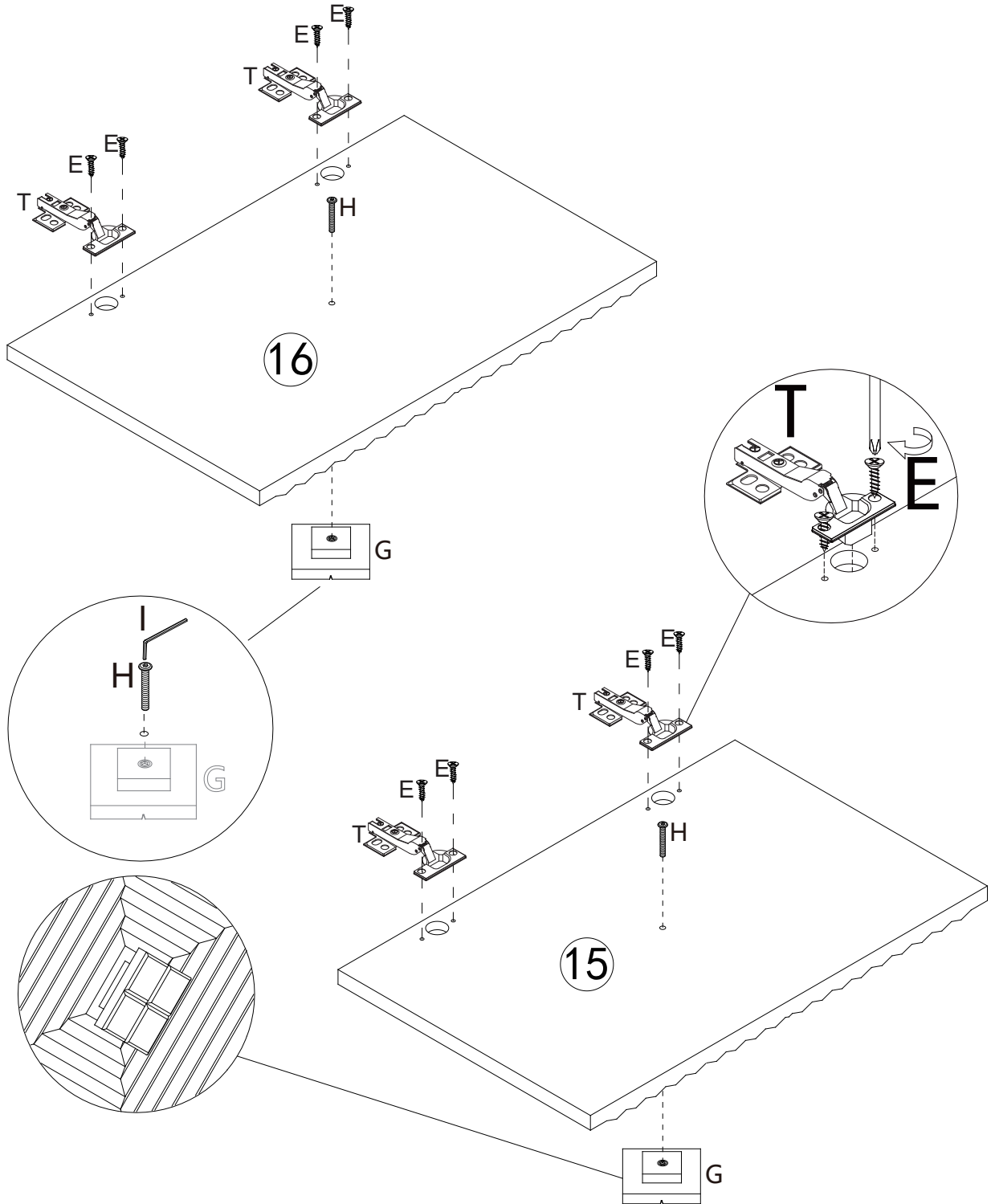
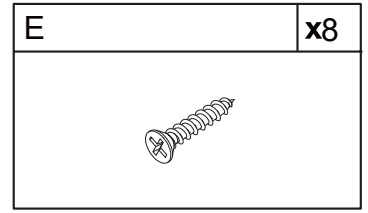
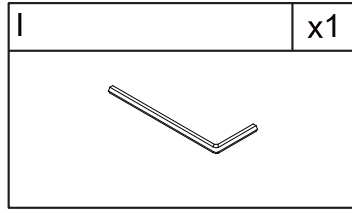
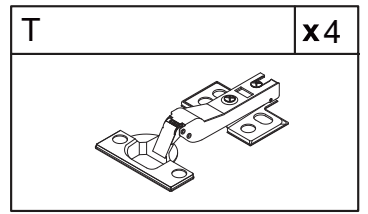
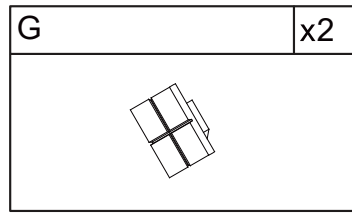
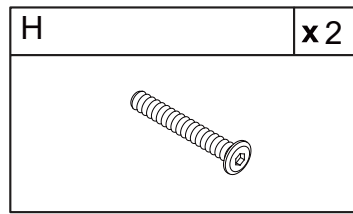

STEP 14

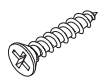
E	x16
	

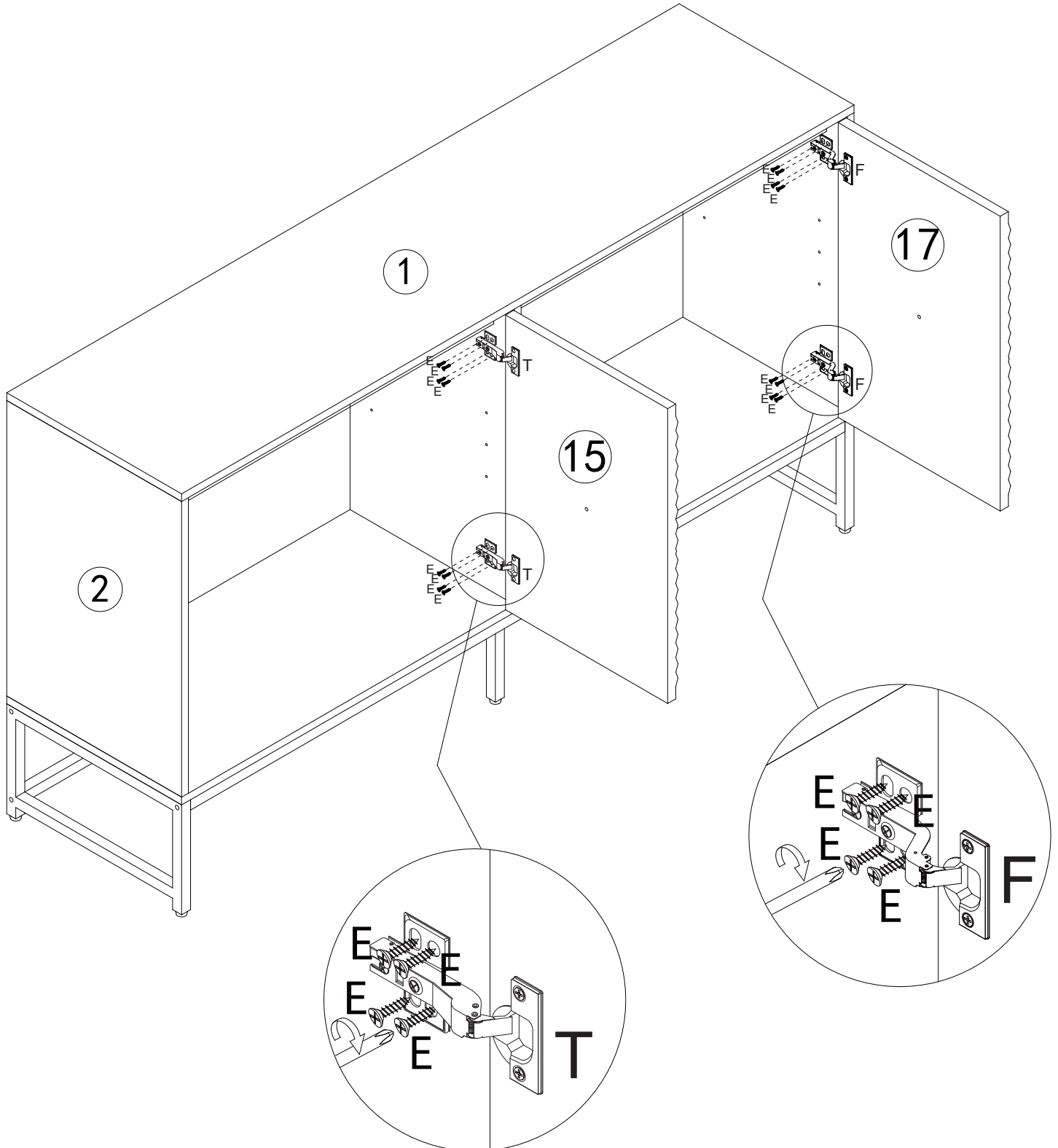
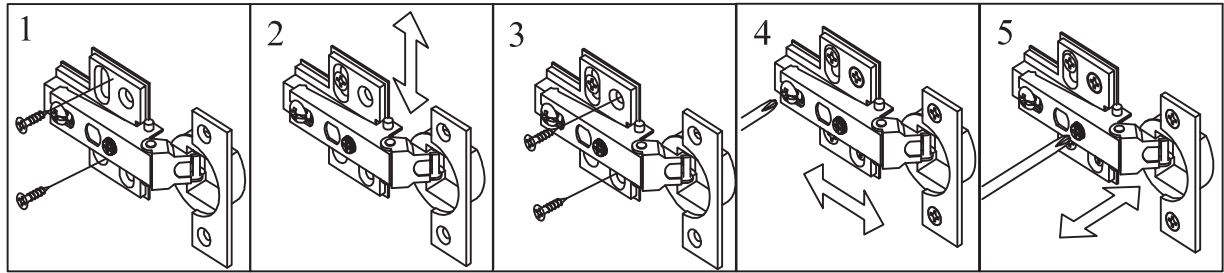

STEP 15

E	x16
	

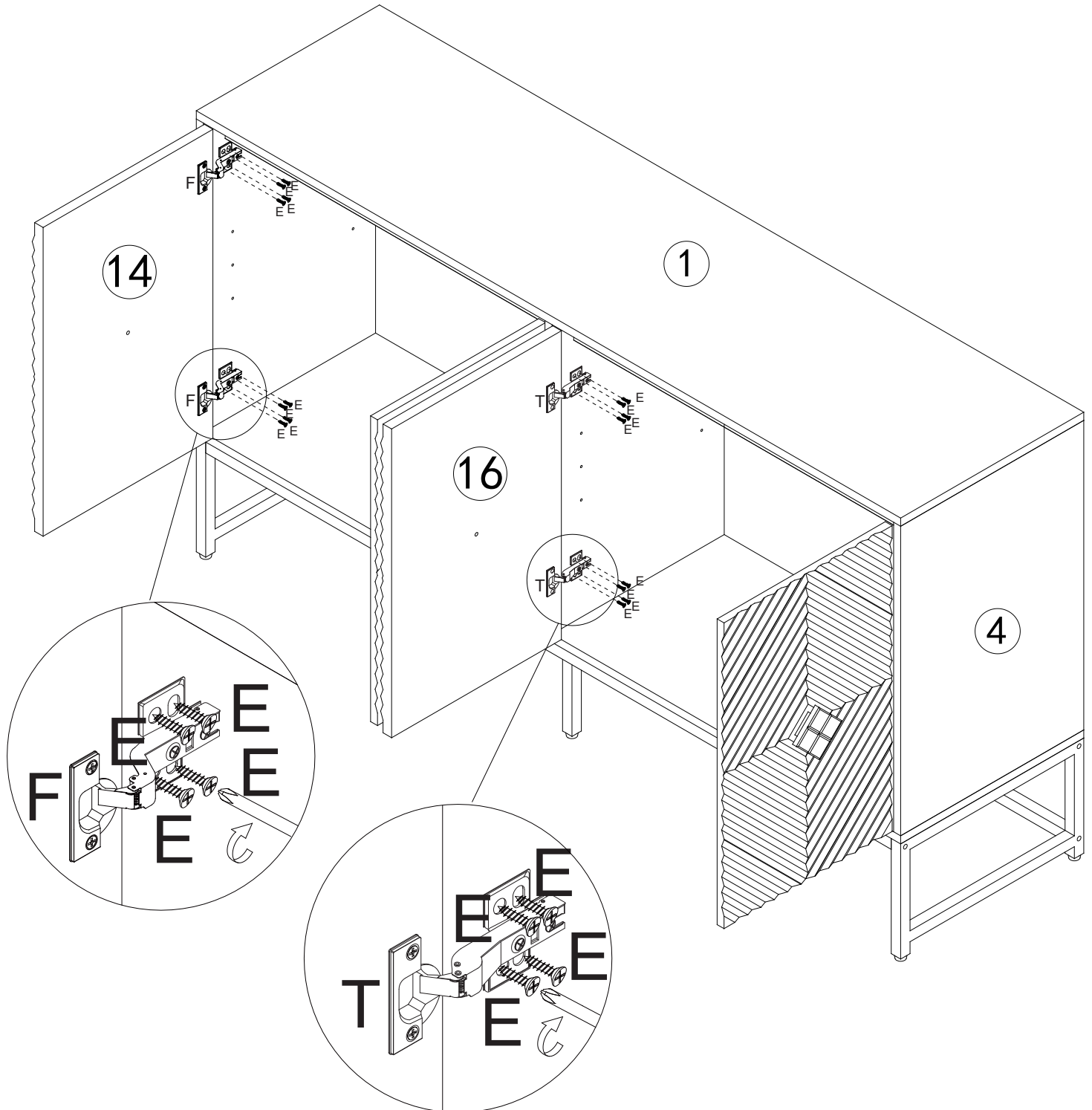
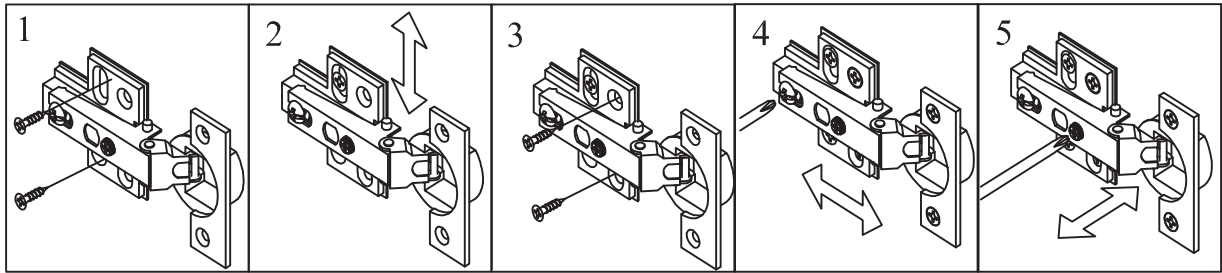

STEP 16

R	x8
	

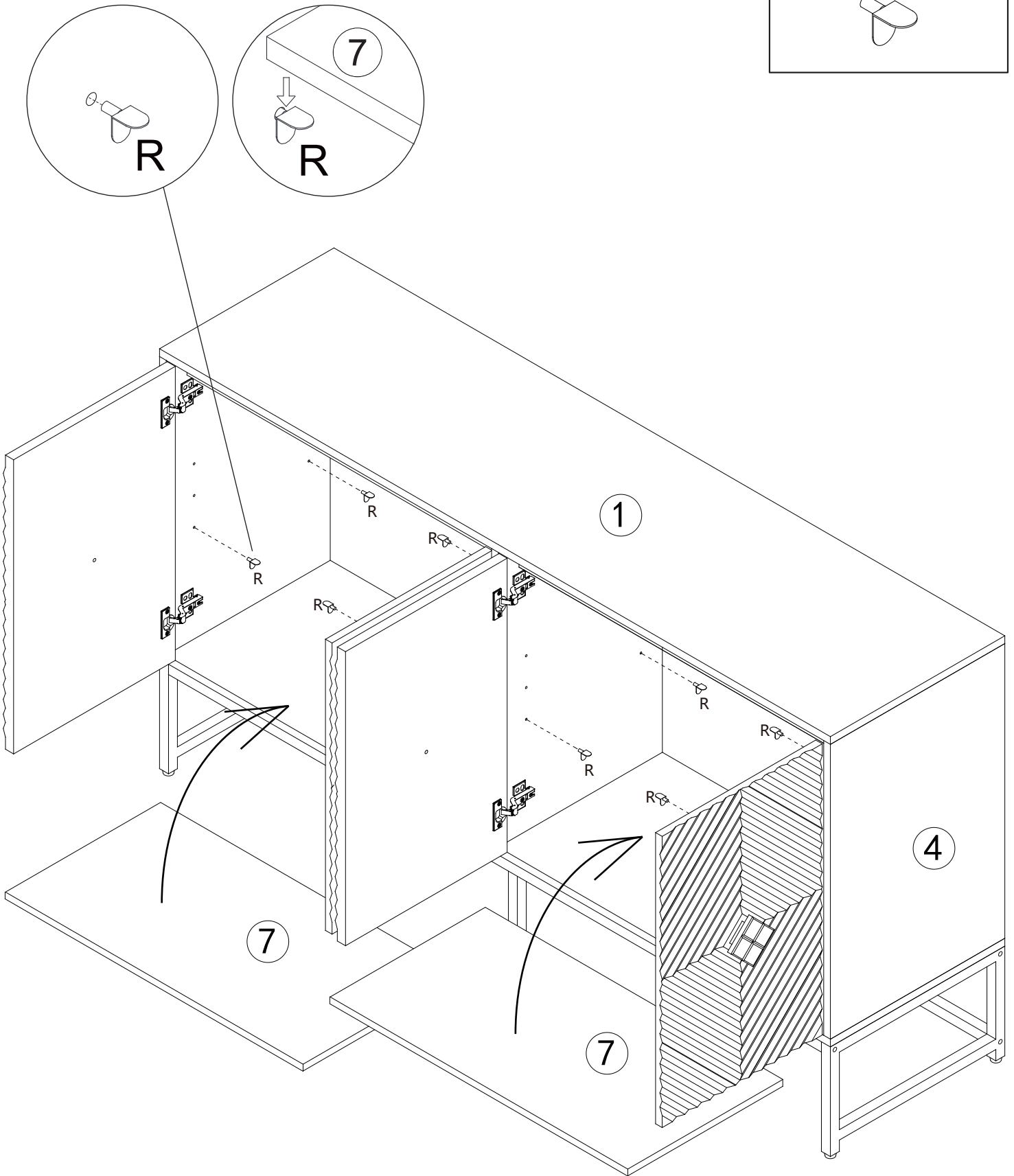

STEP 17

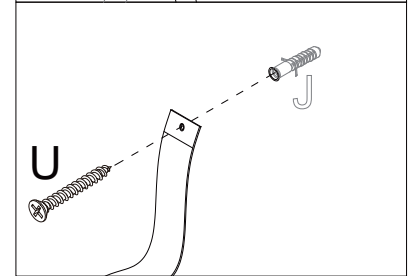
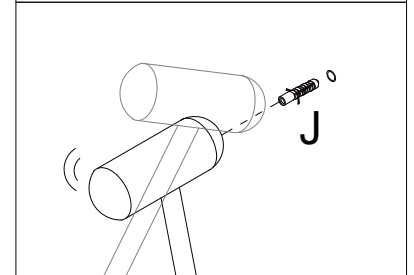
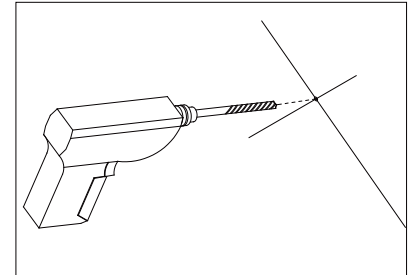
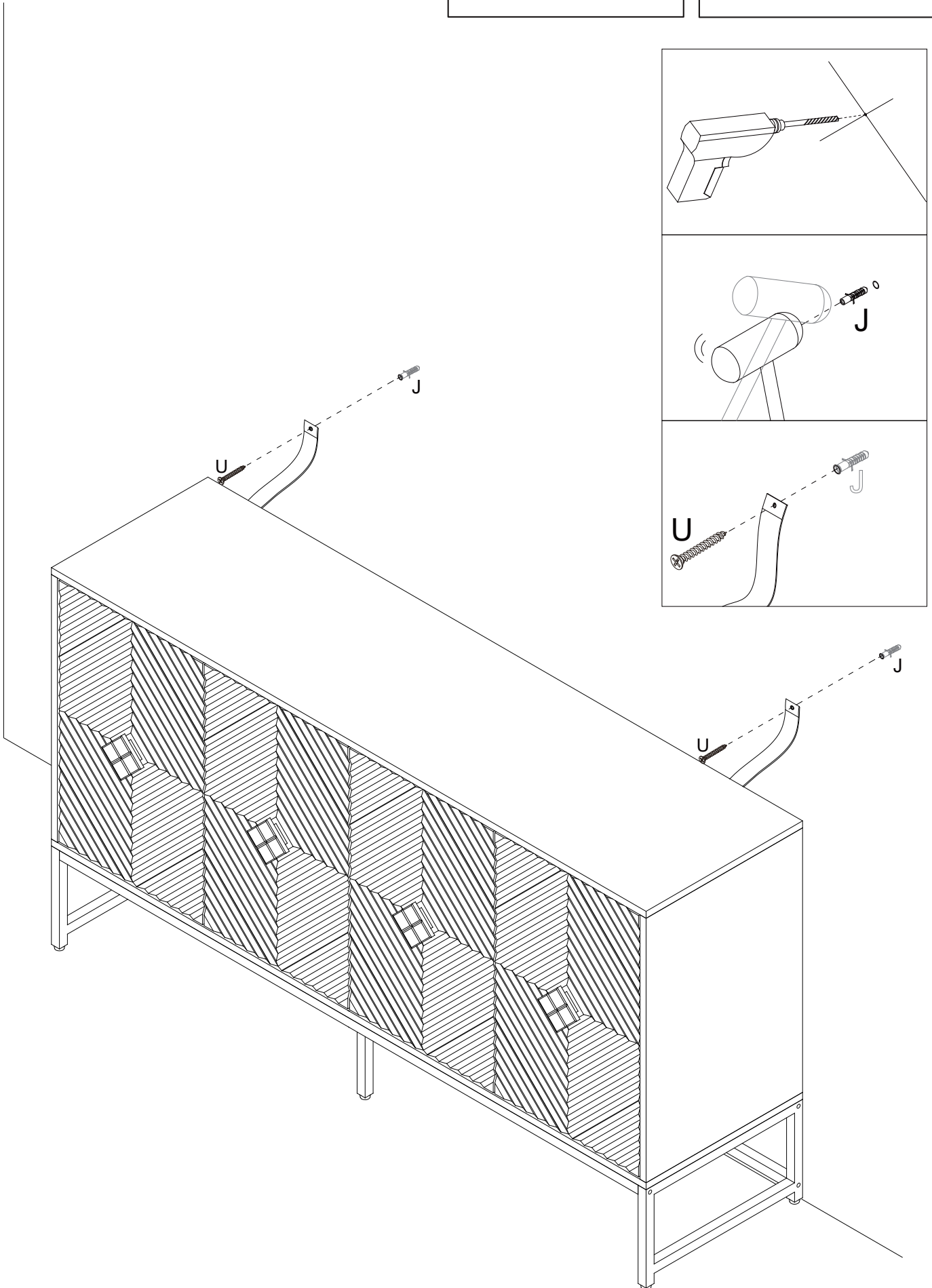
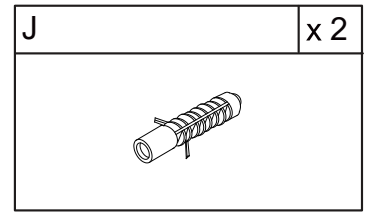
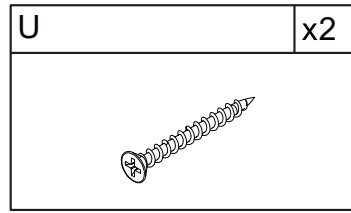

Is your cabinet door looking crooked or unevenly spaced? (Cont.)

If you're still having trouble lining everything up, your next step should be to try to adjust the feet slightly to square up the cabinet & doors. Follow the illustrations below:

If the right door appears to be hanging low, you can adjust the adjustable leveler on the front right until the door is better aligned.

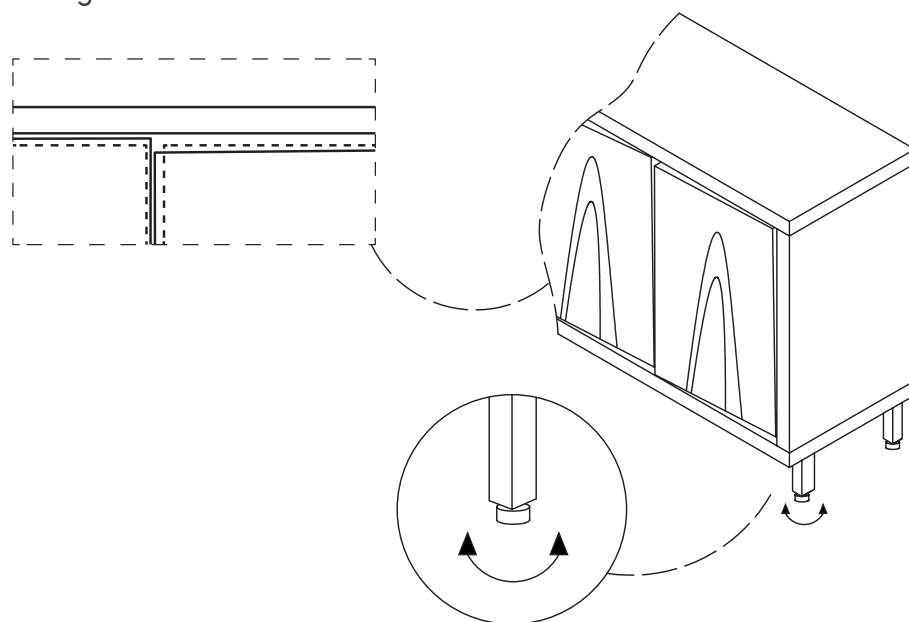

If the left door appears to be hanging low, you can adjust the adjustable leveler on the front left until the door is better aligned.

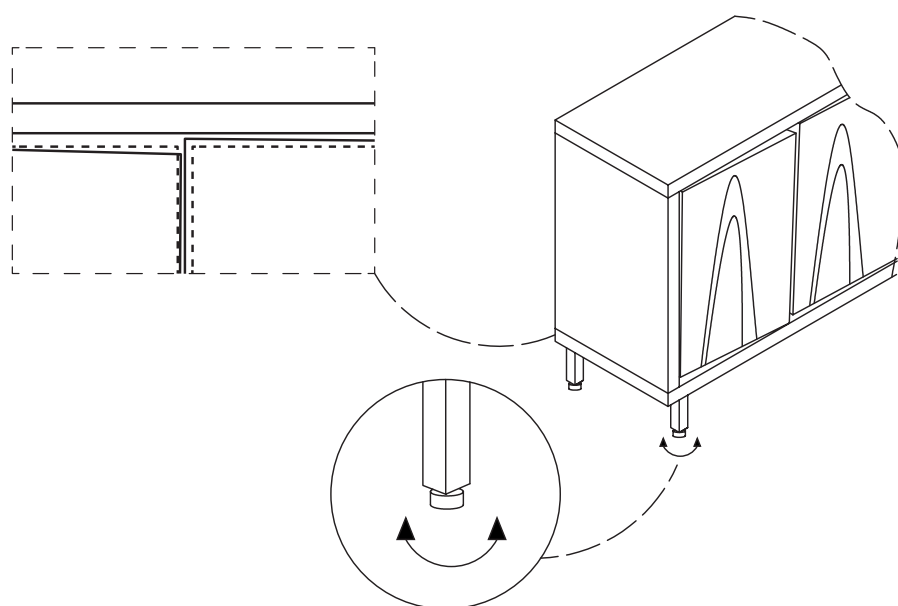

Proper Use

- DO NOT** use for commercial purposes
- DO NOT** use as a step stool or stand on table
- DO NOT** put hot serving liquid directly on the table top
- DO NOT** leave spilled liquid on the table top
- DO NOT** use table if damaged
- DO NOT** exceed weight limit
- DO NOT** make temporary repairs
- DO NOT** use outdoor

Dear Customer:

Thank you for purchasing our product,we wish you satisfy our service,if you have any further questions or any quality issues,please show the belows number and don't hesitate to contact our Customer Service People:

W688202408