

STEP 5

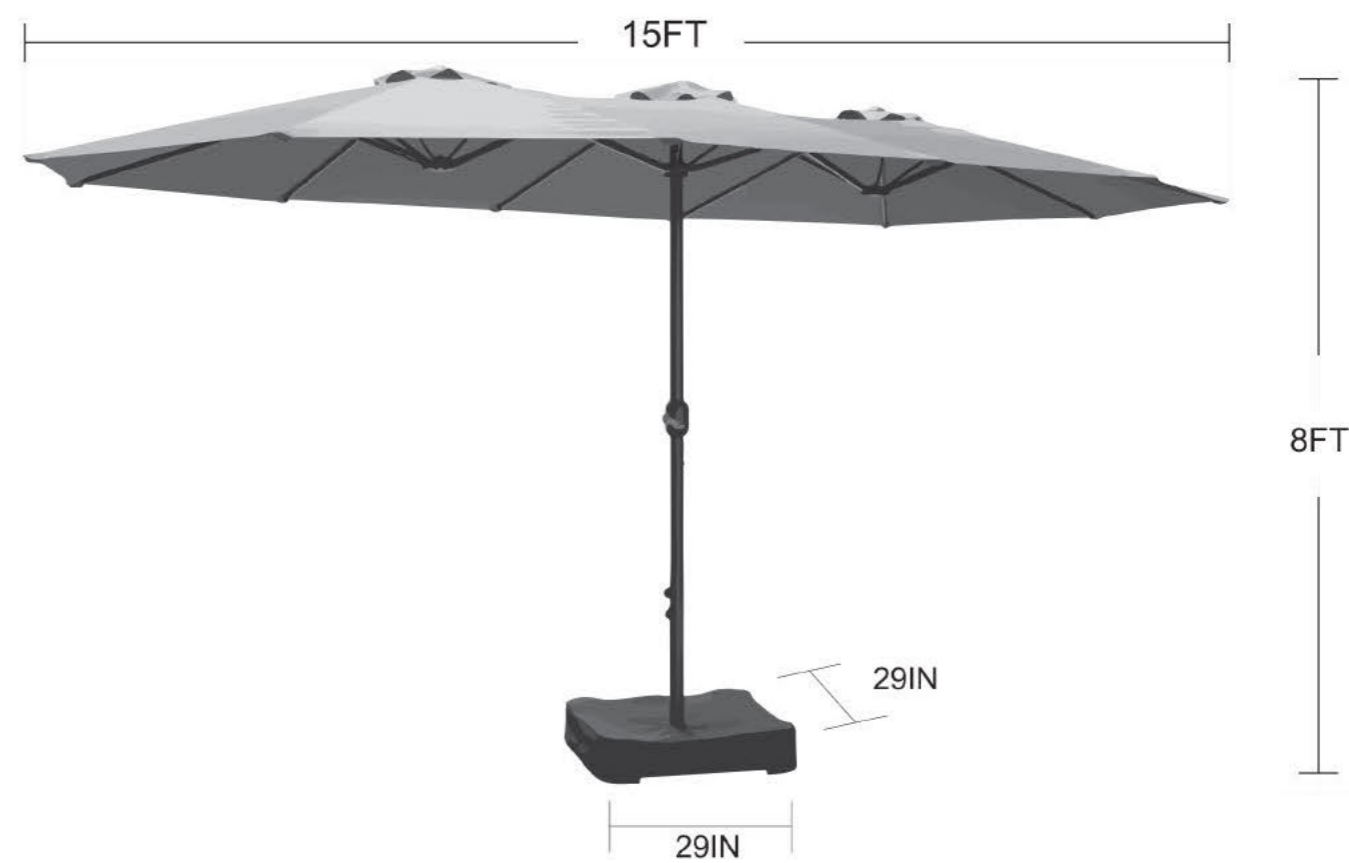

## ASSEMBLY INSTRUCTIONS

- \* Before assembling, make sure that you lay out and identify all parts listed in the parts list.
- \* Keep children away during assembly. This item contains small parts which can be swallowed by children.
- \* All bolts should be hand tightened before use. Never use power tools or excessive force during assembly and tightening of bolts.
- \* Please place the umbrella on a flat protected surface during assembly.
- \* Should you experience any difficulty during assembly or if any parts are missing or damaged, contact service center.

Please provide the following information:

- 1-Model number of the product.
  - 2-Part number and material code of the part from the parts list.
- Most problems can be resolved without returning this product to the retailer. Retain the assembly instructions for future reference.  
SERVICE CENTER TOLL FREE NUMBER

\*Please Email a copy of the store receipt & Model #,  
Part # needed with a Daytime Telephone Number and Address to

## CARE INSTRUCTIONS

- \* Powder coated steel is durable and will last for many years of seasonal use. It is recommended to touch up or repair any scratches to the paint surface to prevent rust.
- \* If you see rust, carefully sand the area using a fine sand paper and apply a rust resistant paint that closely matches the frame color.
- \* It is recommended to use furniture covers (sold separately) to protect the product when not in use, and especially during inclement weather.

:

- \* To clean your canopy, use only mild liquid soap and water, and a soft sponge to loosen and dirt. Never use bleach or cleaning solvents as it will discolor your canopy. Use a mild soap and cloth to clean your aluminum or steel frame.
- \* Allow umbrella to dry naturally in an open position.
- \* It is always recommended that an umbrella cover (sold separately) be used when the umbrella is not in use, as prolonged exposure to the sun's rays will eventually cause canopy fading or discoloring.
- \* **We recommend that this product be closed and secured during high winds and heavy rain conditions.**

## STEP 4

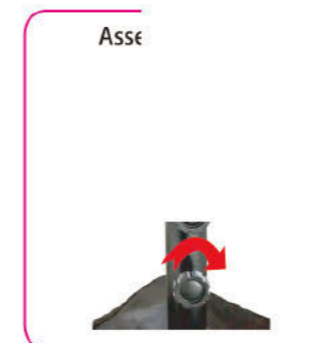
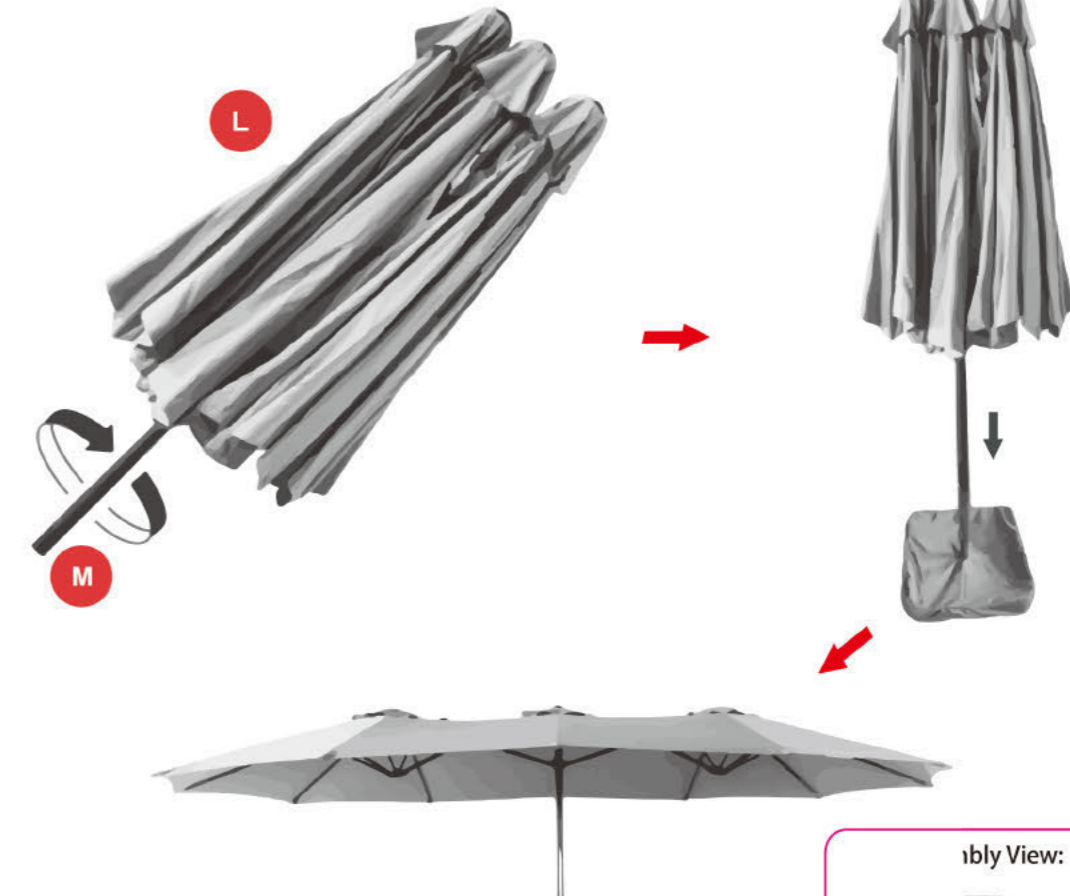
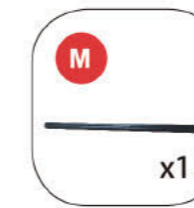
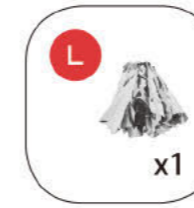

### STEP 3



For proper stability of your offset umbrella. The recommended minimum weight of the sand to be placed into each sand bag is 67.5lbs for a total of 135lbs.



### PARTS LIST



Part A: x1



Part B: x1



Part C: x1



Part G: x4



Part H: x4



Part J: x2



Part K: x1



Part L: x1



Part M: x1

### HARDWARE LIST



Part D: x4  
M8X20



Part E: x4



Part F: x1

STEP 1

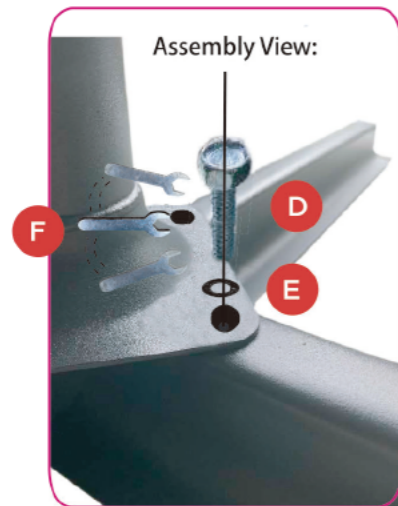
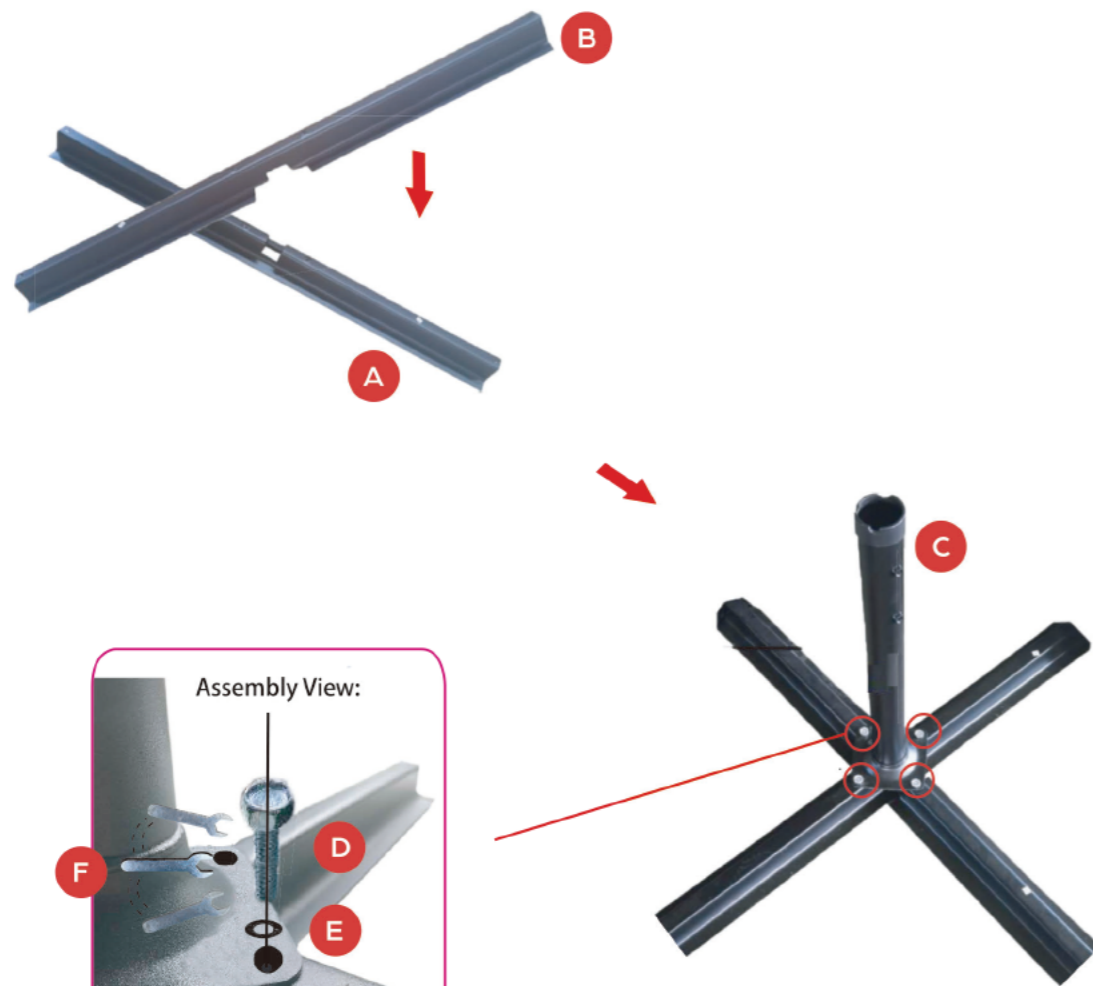
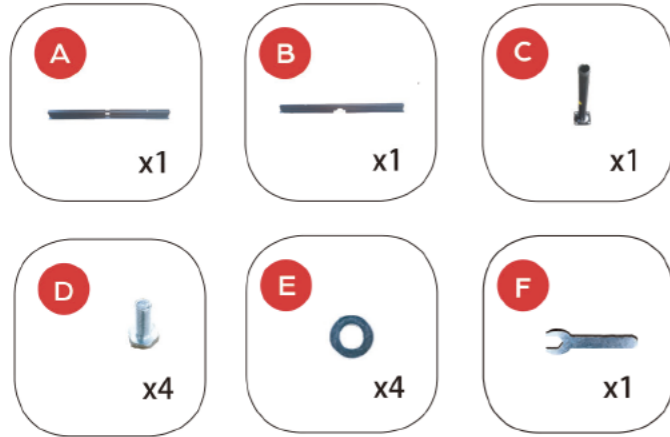

STEP 2

