

# **ELECTRIC FIREPLACE INSERT INSTRUCTION MANUAL**

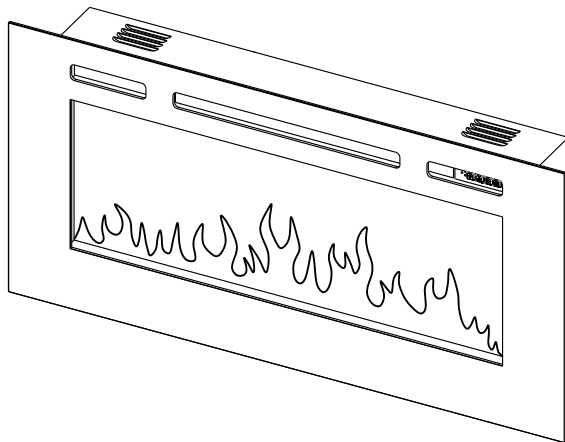

**PLEASE READ THE INSTRUCTIONS CAREFULLY BEFORE INSTALLING AND  
USING APPLIANCE.**

**SAVE THIS INSTRUCTION MANUAL FOR FUTURE REFERENCE.**

## **IMPORTANT SAFETY INFORMATION**

- Read all of the instructions before using this appliance.
- For indoor use only. This appliance is not suitable for use outside the house and only suitable for well insulated spaces or occasional use.
- DO NOT use this appliance in the immediate surroundings of a bath, a shower or a swimming pool.
- DO NOT use this fire as a free-standing appliance. It must always be fixed to the wall.
- This fire must not be located immediately below a socket outlet. This appliance must be earthed.
- This appliance must not be supplied through an external switching device, such as a timer, or connected to a circuit that is regularly switched on and off by utility in order to avoid a hazard due to the inadvertent resetting of the thermal cut out.
- If the power cord is damaged, it must be repaired by the manufacturer, its authorized service centre or professional person.
- “DO NOT COVER”

**WARNING!** in order to avoid overheating, do not allow the appliance to be covered or let the air inlet/outlet become obstructed.

- To reduce the risk of fire, keep textiles, curtains, or any other flammable material a minimum distance of 1 meter from the air outlet.
- Keep the power cord away from hot surfaces and hot conditions. DO NOT route the power lead in front of the appliance.
- DO NOT use this fire in rooms that have explosive fumes in them (for example petrol), or if you are using solvents, glue, aerosol spray or flammable paints, as these may catch fire.

- This appliance can be used by children aged from 8 years and above and persons with reduced physical, sensory or mental capabilities or lack of experience and knowledge if they have been given supervision or instruction concerning use of the appliance in a safe way and understand the hazards involved.
- Children and vulnerable people must be supervised at all times when using this appliance, as some parts can become very hot and cause burns.
- DO NOT use this appliance in small rooms when they are occupied by persons not capable of leaving the room on their own, unless constant supervision is provided.
- Children aged between 3 and 8 years old should only switch on/off the appliance provided that it has been placed or installed in its intended normal operating position and instructions and supervision concerning the safe usage of the appliance are given.
- Cleaning and user maintenance shall not be made by children without supervision.
- This appliance shall not be played with by children.
- Children of less than 3 years should be kept away unless continuously supervised.
- Keep the power plug accessible after installation.
- DO NOT use if there are visible signs of damage to the appliance.
- DO NOT use this heater if it has been dropped.
- Keep the power plug accessible after installation.
- DO NOT use if there are visible signs of damage to the appliance.
- DO NOT use this heater if it has been dropped.

# TECHNICAL SPECIFICATIONS

Supply Voltage: AC 220-240V 50Hz

Maximum power consumption: 2KW

Power for flame effect:

|       |        |        |        |        |
|-------|--------|--------|--------|--------|
|       |        |        |        |        |
| POWER | 11.62W | 13.52W | 16.38W | 18.28W |

Power for fuel bed effect:

|       |       |       |       |       |
|-------|-------|-------|-------|-------|
|       |       |       |       |       |
| POWER | 2.88W | 2.88W | 4.32W | 4.32W |

Power for mood light: DC 12 V, Max 0.96 W, 0.08 A

## HEAT OUTPUT:

Nominal heat output (Pnom): 2KW

Minimum heat output (indicative) (Pmin): 1KW

Maximum continuous heat output (Pmax): 2KW

## AUXILIARY ELECTRICITY CONSUMPTION:

At nominal heat output (elmax): 12.5W

At minimum heat output (elmin): 12.0W

In standby mode (elSB): <0.5W







| TYPE OF HEAT OUTPUT/ROOM TEMPERATURE CONTROL             |     |
|--|-----|
| Single stage heat output and no room temperature control | NO  |
| Two or more manual stages, no room temperature control   | NO  |
| With mechanical thermostat room temperature control      | NO  |
| With electronic room temperature control                 | YES |
| Electronic room temperature control plus day timer       | YES |
| Electronic room temperature control plus week timer      | YES |

| OTHER CONTROL OPTIONS                                |     |
|--|-----|
| Room temperature control, with presence detection    | NO  |
| Room temperature control, with open window detection | YES |
| With distance control option                         | NO  |
| With adaptive start control                          | YES |
| With working time limitation                         | NO  |
| With black bulb sensor                               | NO  |

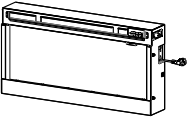
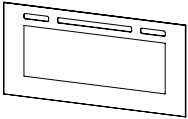
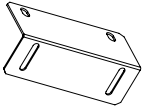
| Control PCB                              | Remote Control Receiver | Remote Control Transmitter  |
|--|-------------------------|---|
| Hardware:<br>RC01-041A01<br>Software: V1 | Hardware: RF290B V1.2   | Frequency: ASK/OOK 433.92MHZ<br>Maximum transmit current: 10mW<br>Hardware: RF290A-TX-V1.3<br>Software: RF290A_C_V0.6.0.hex |

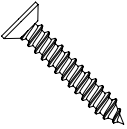
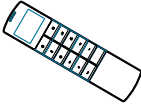
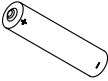
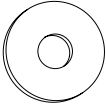
# PARTS AND HARDWARE

- Unpack the fire carefully, make sure that the appliance is intact with no signs of damage caused by transport and no part has been exposed to water. If in doubt, do not use the appliance and contact an authorized service center.
- Keep plastic wrapping away from children.
- Save the original packaging as this may be required in the event of service complaint with product.
- Check that all parts are removed from the packaging.

|  |  |  |  |
|--|--|--|--|
|  <p>1x</p>  |  <p>1x</p>  |  <p>2x</p>  |  <p>4x</p>  |
| <p><b>Firebox</b></p>  | <p><b>Front Glass</b></p>  | <p><b>L Bracket</b></p>  | <p><b>Screw ST4x10</b></p>   |
|  <p>2x</p>  |  <p>4x</p>  |  <p>1x</p>  |  <p>2x</p>  |
| <p><b>Screw ST3x8</b></p>  | <p><b>Screw ST4 x25</b></p>  | <p><b>Remote</b></p>   | <p><b>AAA Battery</b></p>  |
|  <p>4x</p> |  <p>1x</p> |  <p>1x</p> |  <p>1x</p> |
| <p><b>Washer</b></p>   | <p><b>Decorative stone</b></p>   | <p><b>Log set</b></p>  | <p><b>Instruction Manual</b></p>   |

# APPLIANCE DIMENSIONS

Unit:mm

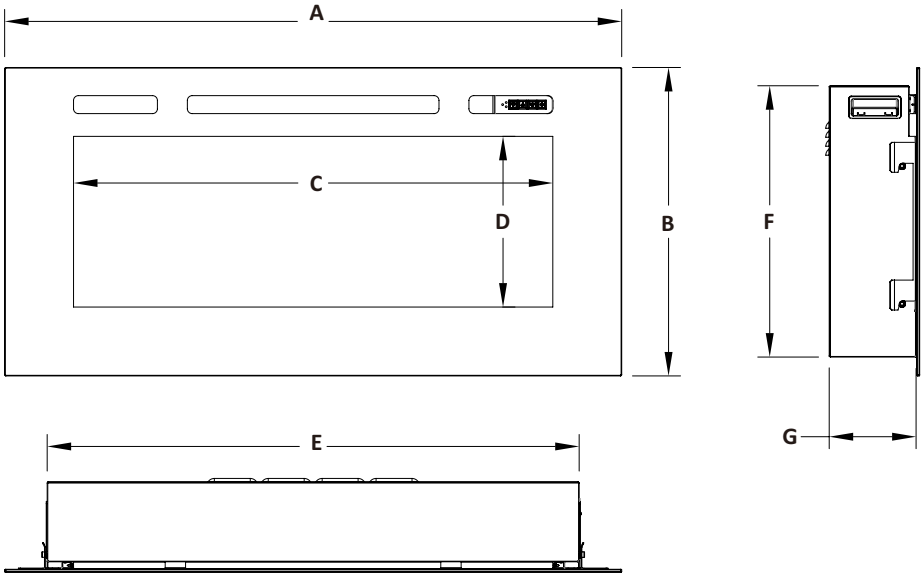

| A    | B   | C    | D   | E    | F   | G   |
|------|-----|------|-----|------|-----|-----|
| 1030 | 515 | 800  | 285 | 888  | 453 | 145 |
| 1230 | 515 | 1000 | 285 | 1088 | 453 | 145 |
| 1530 | 515 | 1300 | 285 | 1388 | 453 | 145 |
| 1730 | 515 | 1500 | 285 | 1588 | 453 | 145 |

## INSTALLATION INSTRUCTIONS

### 1. Tools required

A hammer drill, hammer and a screw driver will be needed.

### 2. Set the appliance

Your new electric fireplace may be installed virtually anywhere in your home. However, when choosing a location ensure that the general instructions are followed.

- For best results, install out of direct sunlight.
- The appliance should be connected to an earthed electrical outlet and it must be easily accessible to allow disconnection.

- A minimum distance of 200 mm from the ceiling or objects must be maintained. The minimum distance to the front side must be at least 900 mm. Choose a location near a socket to avoid using an extension cable.

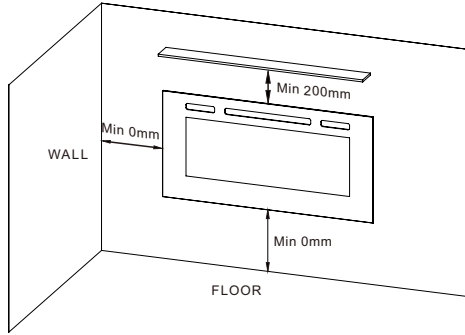

### 3. Install the Appliance

- Prepare the frame and finish it. **Leave 37.5mm at two sides for bracket.**

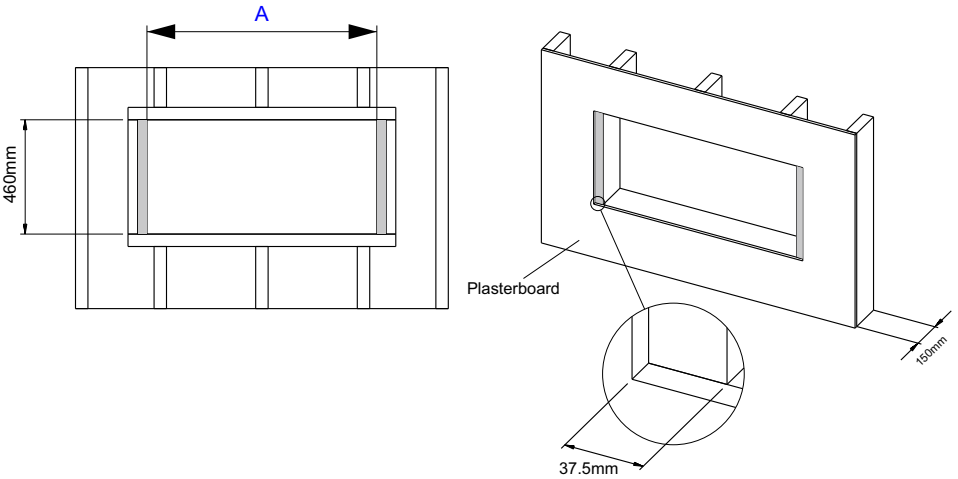

|   |     |      |      |      |
|---|-----|------|------|------|
| A | 925 | 1125 | 1425 | 1625 |
|---|-----|------|------|------|

- Fix the L brackets to the appliance by ST4x10 Screws. Adjust the position of the brackets to make sure the firebox surface will not be lower than the finishing wall.

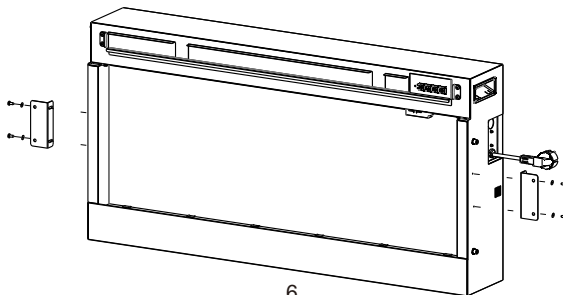

- Push the firebox into the frame and secure the brackets to it. Make sure the front of the firebox isn't lower than the surface of the wall.

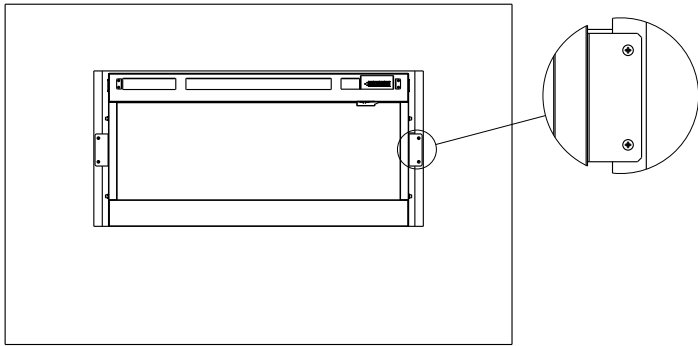
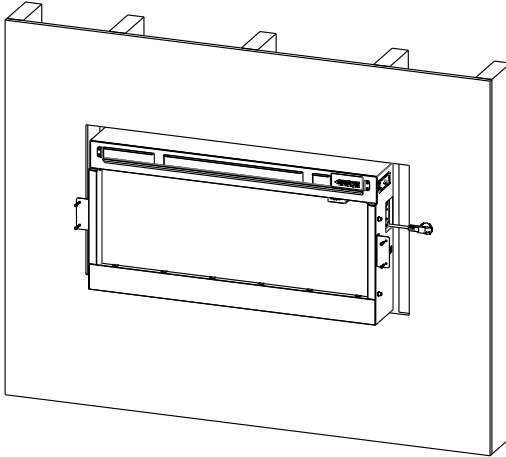

- Arrange the fuel bed with the following two options.

**A:Crystal Effect**

- Evenly spread the small clear crystals across the fuel bed. It is not necessary to use all of the crystal media supplied.
- Randomly space the large crystals throughout the fuel bed.

**B:Log set Effect**



| MEDIUM |   |   |   |   | SMALL |   |   | TOTAL |
|--------|---|---|---|---|-------|---|---|-------|
| A      | B | C | D | E | F     | G | H |       |
| 1      | 2 | - | 1 | 1 | 2     | 2 | - | 9     |
| 2      | 2 | - | 1 | 1 | 3     | 2 | - | 11    |
| 2      | 3 | 1 | 1 | 1 | 2     | 3 | 2 | 15    |
| 3      | 3 | 1 | 1 | 1 | 3     | 3 | 2 | 17    |

- Place the small log first on the base tray and then place the medium log. Finally fill the empty space with small black crystals.

**Arrange the logs according to the image below to achieve the right flame effect.**

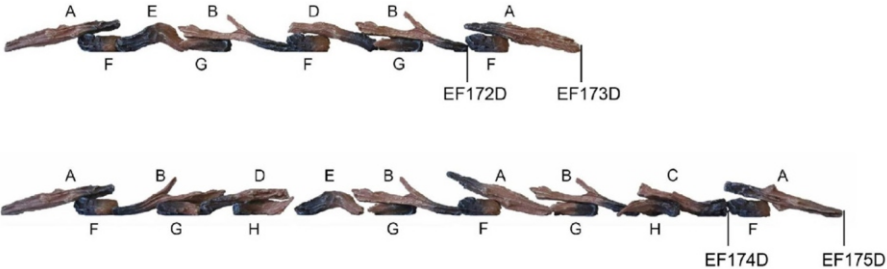

- Carefully hang the front glass on the firebox and secure it with two ST3x8 screws.

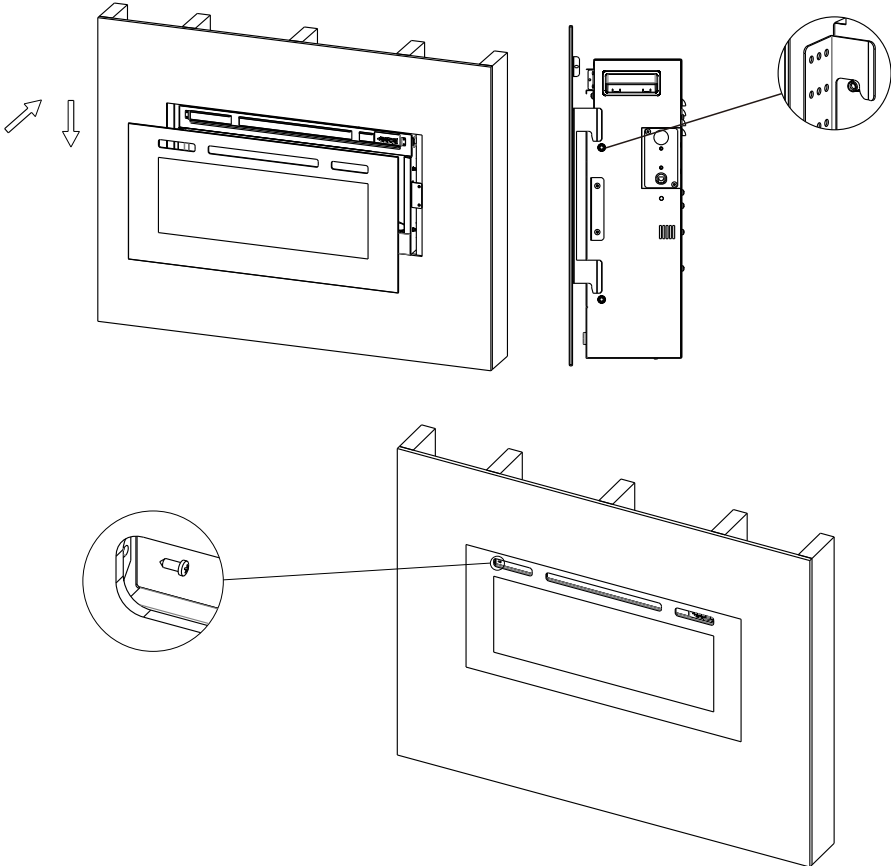

# OPERATING INSTRUCTION

## 1. GENERAL

**WARNING!** Do not operate the appliance if it is damaged or has malfunctioned. If you suspect the appliance is damaged or has malfunctioned, call a qualified service engineer to inspect the appliance, and replace any part of the electrical system if necessary, before re-use.

**WARNING!** To reduce the risk of fire, keep textiles, curtains, or any other flammable material a minimum distance of 1 meter from the air outlet.

- MAKE SURE the plug fits tight in the outlet. Faulty wall outlet connections or loose plugs can cause the outlet to overheat.
- DO NOT disconnect the power at the mains supply whilst the appliance is running. Use the functions on the remote to turn the fire off and ensure the mains switch has been moved to the off position before disconnecting.

## PREPARATION BEFORE USE

- The appliance can be operated conveniently in 2 different ways: manually or via the remote control handset

**NOTE:** To use both remote and manual functions the manual on/off switch must be in 'ON' position.

## MAIN POWER SWITCH

- The mains power switch is located on the control panel located on the lower right corner of the appliance.
- Switch ON (I) before operating either the remote or manual controls.
- A long beep is heard to indicate the fire is ready for use.

## 2. MANUAL CONTROL PANEL

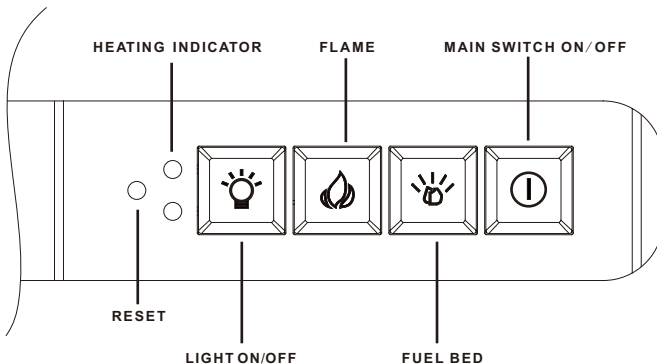

**Main Switch:** Press to turn on or off the appliance.

**LIGHTS ON/OFF:** Press to turn on or turn off both the flame and fuel bed at the same time.

**FLAME:** Press to cycle through 3 flame effects or return to OFF setting.

**FUEL BED:** Press to cycle through 13 fuel bed colours, colour-cycle mode and OFF setting.

**RESET:** Press the “RESET” button to switch communication between the remote control and the appliance.

**NOTE:**

- The manual button controls basic functions, not a full range of controls. Use the remote handset to carry out all functions.
- The controls on appliance will lose the memory for all function settings when the switch is set to the Off Position.
- In order to prevent the product becoming too hot, there is a 10s delay when turning on the heater and a 10s delay when turning off the heater fan.

### 3. REMOTE CONTROL

**NOTE:**

- Ensure that the handset batteries are new and inserted correctly.
- Aim the remote control at the remote receiver which is behind the right side of the flame screen.

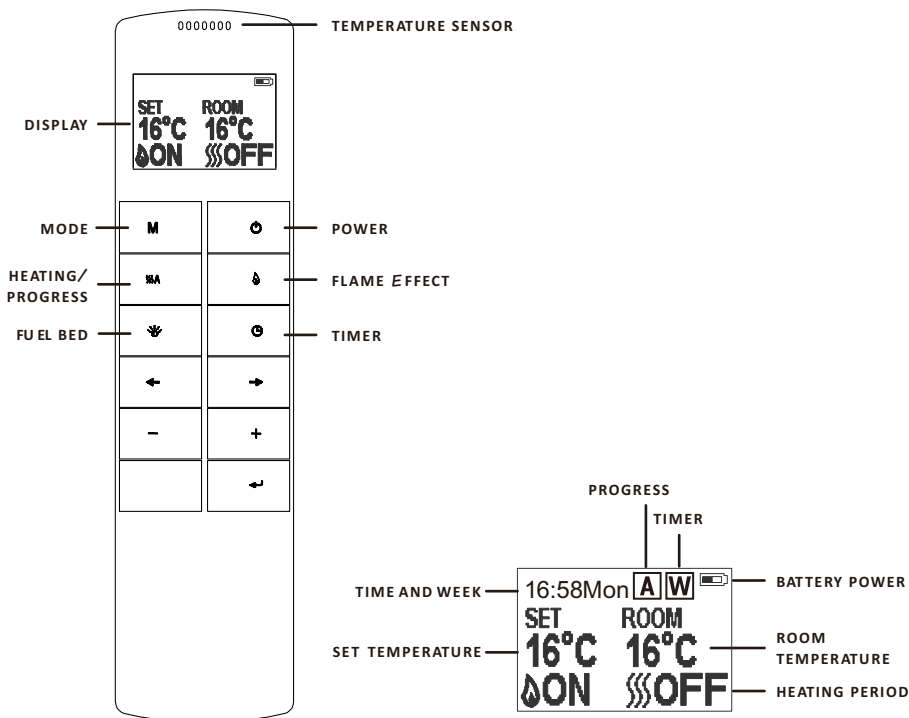

**NOTE:** This is a thermostatic remote control. The remote should be in the same room as the fireplace and placed on a flat surface. It senses the room temperature, so it must not be placed in a position that allows the appliance hot air to blow on it and affect the thermostatic reading.

The communication frequency between the appliance and remote has already been set up. If you have difficulty with the remote communicating with the appliance, please follow instructions Step 3.33.

## Standby for Remote Controls



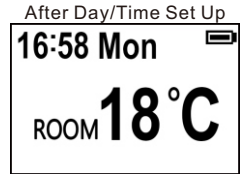

- 3.1 The screen shown to the right is when the remote controls is in standby mode .



## Turn on/off



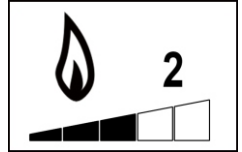

- 3.2 Press  to turn on/off Flame, Fuel Bed and heating in Normal Mode or turn on/off Flame, Fuel Bed only in Daily and Weekly Timer Mode .

## Flame Effect

- 3.3 Press  to enter the flame effect adjustment screen.
- 3.4 Press the '' and '' button to select 3 different flame colors.
- 3.5 Press the '' and '' button to select 5 levels of brightness and OFF setting.







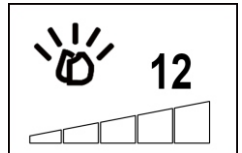

## Fuel Bed

- 3.6 Press  to enter the fuel bed adjustment screen.
- 3.7 Press the '' and '' button to select 14 different fuel bed colors (the fourteenth is the color cycle mode).
- 3.8 Press the '' and '' button to select the 5 levels of brightness and OFF setting.



## Normal Mode

- 3.9 Normal control mode is factory set. If it is not, then press button  until the logo  shows up at the upper right corner of the screen.
- 3.10 Press the '' and '' button to adjust the temperature from 17°C to 25 °C by 2 intervals.
- 3.11 Press  button to turn on/off heat,  ON  OFF will show at the lower of the screen.

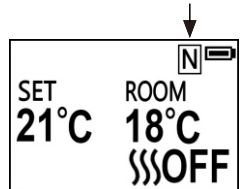

**NOTE: It is normal for the fan heater to stop running for periods of time. This happens because the room temperature is at or above the temperature set on the remote control. The heater indicator will be turned off after 10s if you have the flame ON. The heater indicator will stay ON if you use the heating function only.**

## Count Down Timer

**NOTE: This setting is only for operating in normal mode. It allows the appliance to go into standby after a set period .**



- 3.12 Press  to cycle through the settings from 0.5 hours to 9 hours, and then OFF. The timer logo and time will show on the screen.

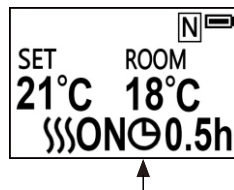

**The heater must be in ON position.**

The heater can be automatically run by using daily timer and weekly timer on the remote.





## Set up Day, Time and Comfort temperature.

- 3.13 Press  to turn on the remote handset. Hold the button  for 3 seconds to enter the setting screen.

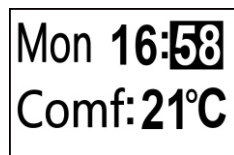
- 3.14 Press the '' and '' button to choose Day, Time or your comfortable temperature. your selection will be highlighted.



- 3.15 Press the '' and '' button will adjust the number.



- Time: 24-hour system
- Select your comfortable temperature from 15-25°C.
- Temperature unit: °C、°F

## Daily Timer Heating

- 3.16 The following are preset heating periods, which can be altered if needed



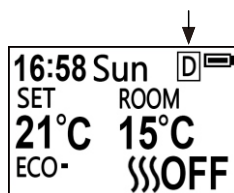

06:00 until 08:30

17:00 until 22:00

- 3.17 Press  until  shows at the upper right corner of the screen, then enter the daily timer heating mode.



- 3.18 Hold the button  for 6 second to enter the daily timer setting. Up to 3 heating start time periods can be set.

- Press '' or '' to choose hour or minute, press '' or '' to set the time.
- Minute will increase/decrease by 15 minutes per press.

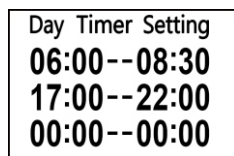

- Hold **←** for 3 seconds or wait for 10 seconds to save and exit the heating time setting.

### 3.19 Adjust the set temperature

Press the ' - ' or ' + ' button to increase or decrease the temperature to suit your comfort temperature setting.

ECO means 2°C lower than your comfortable temperature setting,

ECO- means 4°C lower,

COMF+ means 2°C higher,

COMF++ means 4°C higher.

3.20 To check your daily timer settings, press **←**.

3.21 If heating needs to be turned off, it will be necessary to go back to the Normal Mode to turn off.

### Weekly Timer Heating

3.22 The following are preset heating periods, which can be altered if needed.

#### From Monday to Friday

06:00 until 08:30

17:00 until 22:00

#### From Saturday to Sunday

06:30 until 09:30

11:00 until 13:00

17:00 until 22:00

3.23 Press M until **W** shows at the upper right corner of the screen, then enter the weekly timer heating mode.

3.24 Hold **←** button for 6 seconds to enter the weekly timer setting.

- Press ' ← ' or ' → ' to move the cursor (a flashing underline), press the **←** button in the corresponding week position to select (the character is highlighted) or cancel (the character is displayed normally) the current setting. Several days can be selected together.

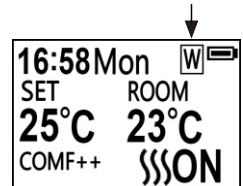

- Press the ' → ' button to move the cursor to the time period setting area. Press ' ← ' or ' → ' to choose hour or minute, press ' - ' or ' + ' to set the number.
- Up to 3 heating start time periods can be set.
- Minute will increase/decrease by 15 minutes per press.
- Press the ↵ to set the heating time for the selected day and return to the week line.
- Hold ↵ for 3s or wait for 10s to save and exit the heating time period setting.

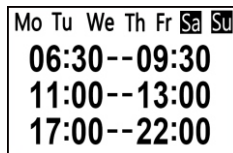
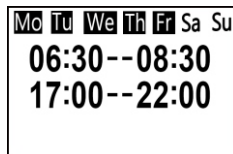

3.25 Press ↵, ' ← ' and ' → ' to check your weekly timer settings.

3.26 If heating needs to be turned off, it will be necessary to go back to the Normal Control Mode to turn off.

### Advance Mode

3.27 Under the daily and weekly timer mode, Press: ⏏

3.28 To turn the heater off when the heater is on during preset heating periods.

3.29 To turn the heater on when the heater is off during preset heating periods.

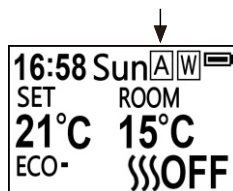

### Adaptive Start Control

3.30 Learning from the previous heating cycle enables the appliance to judge the appropriate advance time to turn on the heater to ensure that the set temperature is reached at the set time. For example, if your timer is set to start at 18:00 and temperature is set to 23°C, the fire may for example come on at 17:30 to ensure the room is 23°C at 18:00.

## Window Open Detection

- 3.31 When the transmitter detects a rapid drop in room temperature, it will be judged as a window open, the warning icon will be displayed and the heater will be turned off automatically.
- 3.32 After the indoor temperature has risen or a manual override of the warning (by operating remote control) has been done, the fire will return to normal working state.



## Set up the communication between the remote and appliance

- 3.33 The operations below should be carried out before programming in the case of replacing the remote control or the appliance cannot be controlled by the remote:
- Hold the reset button on the appliance for 3 seconds (pen Point may be needed) until you hear 3 short beeps from the unit, release the button.
  - Press the  button on the remote, the programming is finished when you hear a long beep from the appliance.
- 3.34 Resetting the code for remote control is necessary if the appliance operates wrongly or the remote control does not operate correctly.
- Open the back cover of the remote control.
  - Press the Reset button on remote control
  - Refit the back cover of the remote control
  - Follow the steps 6b.36



## Important Safety Information for Remote Controls

- 3.35 Use the thumb press and push the bar figure on the back cover down simultaneously, and then take out the cover and remove the battery or insert the battery. Finally, place the cover back on the rear of the remote;
- 3.36 Two AAA R03 alkaline batteries are required for the remote control.

- 3.37 Exhausted batteries are to be removed from the appliance and safely disposed of.
- 3.38 This Non-rechargeable batteries are not to be recharged.
- 3.39 Different types of batteries or new and used batteries are not to be mixed.
- 3.40 Batteries are to be inserted with the correct polarity.
- 3.41 If the appliance is to be stored unused for a long period, the batteries should be removed.
- 3.42 The supply terminals are not to be short-circuited.

### **Resetting the Thermal Cut Out**

- 3.43 The appliance is fitted with an Electronic Safety Control (E.S.). This is a safety device, which switches off the fire if, for any reason, the appliance overheats, e.g. when covered. If the heater stops operating while the flame effect continues working normally, this indicates that the E.S. Control is in operation. The E.S. Control can only be re-set after the appliance has cooled down, and the appliance has been reset. Re-setting of the E.S. Control proceeds is as follows:
  - 3.44 Switch off the appliance (Manual On/Off switch) and leave it of for approximately 10-15 minutes.
  - 3.45 Remove any obstruction to the fan heater outlet or fan blades etc. Make sure that the power supply is disconnected with the plug socket outlet while doing this.
  - 3.46 Switch on the appliance and the E.S. Control will be re-set.
  - 3.47 Ensure that the appliance is functioning correctly. If the E.S. Control operates again, the appliance should be checked by a competent electrician.

## MAINTENANCE

### WARNING:

Before any maintenance or cleaning of the exterior of the fireplace, the unit should be disconnected from the power supply until it is cool off.

ALWAYS turn the heater OFF and unplug the power cord from the outlet before cleaning, performing maintenance, or moving this fireplace. Failure to do so could result in electric shock, fire, or personal injury.

### Remote Controls Battery Replacement

When the batteries are at full power, the battery symbol will show 

When the batteries are half full, the battery symbol will show 

When the batteries are out of power and need replacing immediately, the battery symbol will show 

## REMOTE HANDSET BATTERY REPLACEMENT

Replace with two AAA battery. Make sure the batteries are installed correctly in the remote control.

## MAINTENANCE OF MOTORS

The motors used on the fan and flame effect are pre-lubricated for extended bearing life and require no further lubrication. However, periodic cleaning/vacuuming of the fan/heater unit is recommended.

## CLEANING THE FIREPLACE

You can clean the exterior of the fireplace with a soft, damp, lint-free cloth. DO NOT use cleaning or polishing products. To remove fingerprints or other marks on the front glass panel, use a soft, damp, lint-free cloth with a good quality household glass cleaner. The front glass panel should always be completely dried with a clean, lint-free cloth or paper towel.

**WARNING!** Abrasive cleaners should not be used on the glass panel. Liquids should not be sprayed directly onto any surface of the unit.

## DISPOSAL



Meaning of crossed-out wheeled dustbin: Electrical appliances should not be disposed as unsorted municipal waste. Separate collection facilities should be used in the disposal of electrical appliances. To have this appliance processed at the end of its useful life please contact WEEE Care Plc on 0844 8002004. The relevant producer number is WEE/MM3069AA.



This fire complies with the Safety Standards BS EN 60335-1 and BS EN 60335-2-30 which covers the essential requirements of the Electrical Equipment (Safety) Regulations 2016 (S.I.2016/1101) and the EMC standards BS EN 55014-1; BS EN 55014-2; BS EN 61000-3-2 and BS EN 61000-3-3 which covers the essential requirements of the Electromagnetic Compatibility Regulations 2016 (S.I.2016/1091). and the RED standards BS 300220-2, BS 301489-1, BS 301489-3 and BS 6247 which covers the essential requirements of the Radio Equipment Regulations 2017.