

# THE CHANGING TABLE WITH HAMPER AND BASKET

Assembly Instructions. Adult Assembly Required.

Read all instructions before use.

**This manual is part of the product and  
must be kept for future reference.**



### USE AND CARE INSTRUCTIONS:

Wipe the table, pad, and safety belt clean with a damp cloth and mild soap as needed. Dry thoroughly.

Spot clean baskets as needed.

Do not immerse baskets in water.

### ASSEMBLY TIPS!



*Review the entire manual before beginning. Leave hardware slightly loose during assembly and then go back and tighten fully at the end.*

*If using a power screwdriver, keep torque setting low and go slow to prevent damage to the product.*



## WARNING

ADULT ASSEMBLY REQUIRED - TWO PERSON RECOMMENDED.  
KEEP OUT OF REACH OF CHILDREN UNTIL ASSEMBLY IS COMPLETE.



## WARNING - FAILURE TO FOLLOW THESE WARNINGS AND THE INSTRUCTIONS COULD RESULT IN SERIOUS INJURY OR DEATH

**READ ALL INSTRUCTIONS** before use of this product.  
Keep instructions for future use.

Do not use the product if it is damaged, broken, or missing parts.  
**DO NOT** allow anyone to climb, sit on, stand on, or play on or inside of this product. It is not a seat, step stool, or ladder.

**Periodically check** to make sure all the hardware remains tight.

No product is a replacement for adult supervision



# WARNING

**FALL HAZARD:** Children have suffered serious injuries after falling from changing tables. Falls can happen quickly.











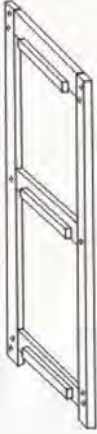
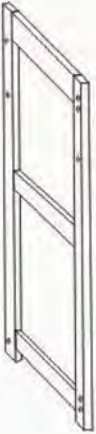
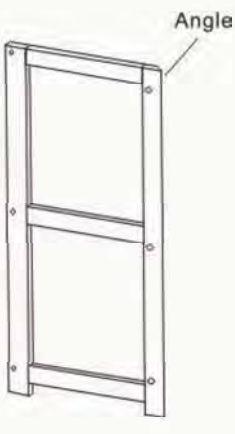









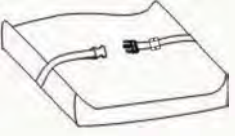

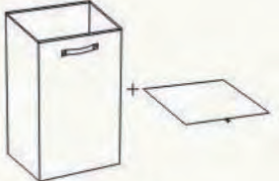
- **STAY** within arm's reach of your child.
- **READ ALL INSTRUCTIONS** before use of this changing table.
- **DO NOT** use the changing table if it is damaged, broken, or missing any parts.
- The baby's **maximum weight** for use of this product is **30 pounds (13.64 kg)**.
- This manual is part of the product. **KEEP INSTRUCTIONS for future use.**
- **NEVER** use the changing table without the safety belt properly installed.
- **ALWAYS** use the safety belt and keep at least one hand on Baby at all times.
- **ALWAYS** secure the changing pad to the changing surface by placing it onto the top shelf under the safety belt as shown in this manual.
- **This product is not intended to be used as a changing table without the top safety rails, included changing pad, and safety belt installed.** Use of the product without this may result in death or serious injury to your child from falling. Follow all instructions on attaching and using the safety rails, changing pad, and safety belt.
- **NEVER** leave your baby unattended, not even for a moment, when you are changing Baby's diaper or dressing your child on the table.
- Product and/or hardware may include small parts or screws with sharp points. **Choking Hazard!** Keep unassembled parts out of the reach of small children.
- Use only the changing pad, parts, and hardware provided by our.
- **DO NOT** allow children or pets to climb on or play on the table.
- **Periodically check** to make sure all the bolts and screws remain tight and **regularly** retighten the bolts as needed.
- Keep child's skin/body clear of the safety belt buckle when snapping/unsnapping to prevent injury.
- Buckle is not securely fastened unless you hear an audible "click" to indicate the parts have connected securely together.
- If adjusting the length of the belt, always pull extra belt slack through the safety clip so that the belt lies flat.
- **NEVER** allow child to stand up on the table due to risk of falls and injury or death.



# WARNING

**SUFFOCATION HAZARD:** Babies have suffocated while sleeping on changing pads. Changing pads are not designed for safe sleeping.

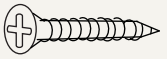

- **NEVER** allow Baby to sleep on the changing pad.

 <p><b>Ax 1</b> LEFT CENTER FRAME</p>	 <p><b>Bx 1</b> RIGHT CENTER FRAME</p>	 <p><b>Cx 1</b> LEFT SIDE FRAME</p>	 <p><b>Dx 1</b> RIGHT SIDE FRAME</p>
 <p><b>Ex 2</b> FRONT RAILS</p>  <p><b>Fx 2</b> REAR RAILS</p>	 <p><b>Yx 1</b> MIDDLE SHELF</p>	 <p><b>Gx 3</b> LEFT SIDE RAILS</p>	 <p><b>Hx 3</b> RIGHT SIDE RAILS</p>
 <p><b>Ix 1</b> BOTTOM SHELF</p>	 <p><b>Jx 1</b> TOP SHELF</p>	 <p><b>Kx 6</b> SIDE SHELVES</p>	 <p><b>Lx 2</b> BASKET TRACK</p>
 <p><b>Mx 1</b> CHANGING PAD WITH BELT</p>	 <p><b>Nx 1</b> BASKET BODY &amp; BOTTOM PANEL</p>	 <p><b>Ox 1</b> FOLDING HAMPER &amp; BOTTOM PANEL</p>	 <p><b>Qx 14</b> Ø 6x45mm</p>
 <p><b>Rx 14</b> Ø 6x12mm</p>	 <p><b>Sx 16</b> Ø 6x25mm</p>	 <p><b>Tx 8</b> Ø 6x20mm</p>	 <p><b>Ux 2</b> Ø 4x20mm</p>
 <p><b>Vx 2</b> WASHERS &amp; NUTS</p>	 <p><b>Wx 10</b> PEGS</p>	 <p><b>Xx 18</b> Ø 4x20mm</p>	 <p>TOOL REQUIRED (NOT INCLUDED)</p>

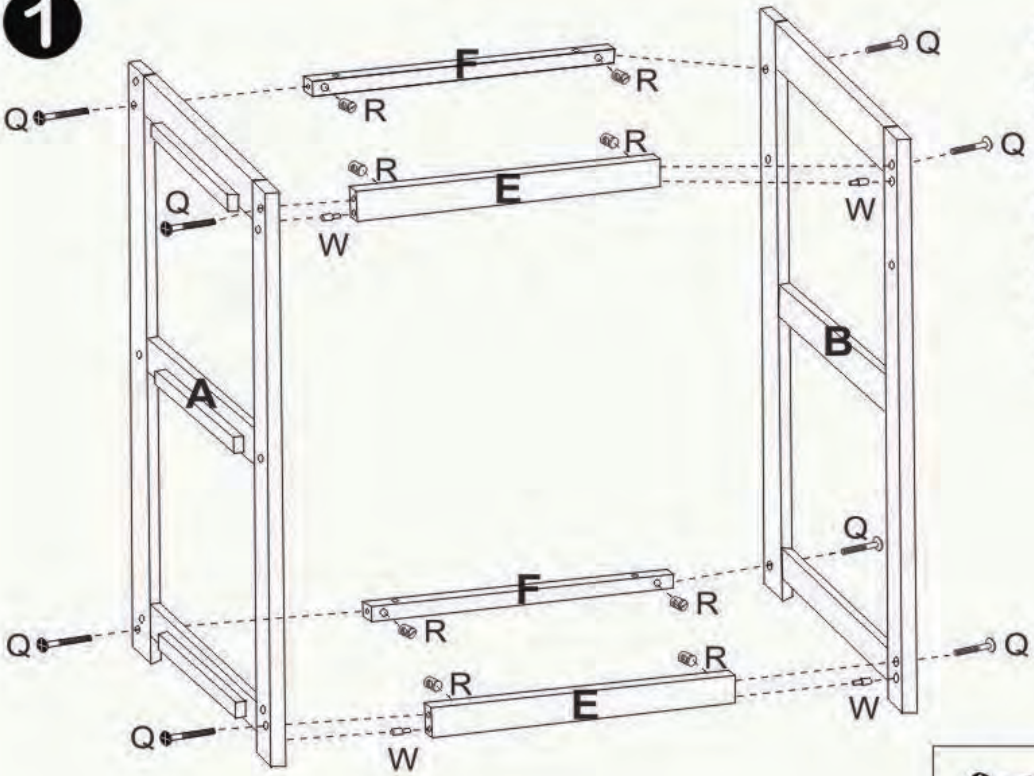
**1**





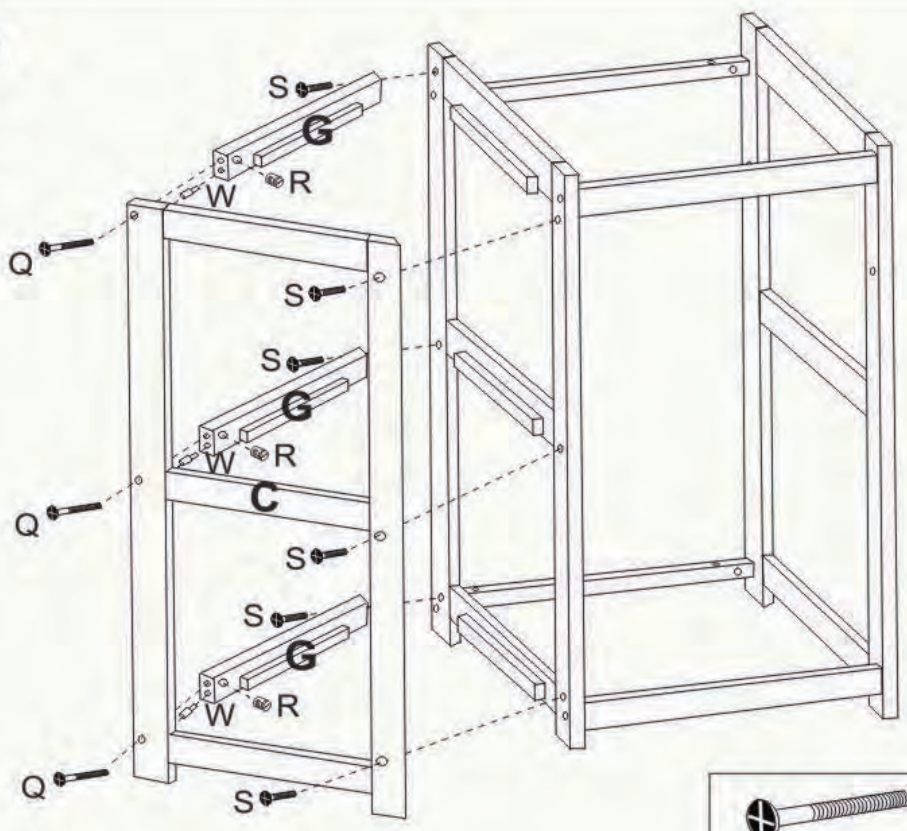

**PLEASE REVIEW ALL STEPS PRIOR TO BEGINNING SO YOU WILL BE FAMILIAR WITH ALL PARTS AND THEIR FINAL POSITIONS.**

		
<b>Qx8</b>	<b>Rx8</b>	<b>Wx4</b>
$\varnothing 6 \times 45 \text{mm}$	$\varnothing 6 \times 12 \text{mm}$	

**2**



			
<b>Qx3</b>	<b>Rx3</b>	<b>Wx3</b>	<b>Sx6</b>
$\varnothing 6 \times 45 \text{mm}$	$\varnothing 6 \times 12 \text{mm}$		$\varnothing 6 \times 25 \text{mm}$

3

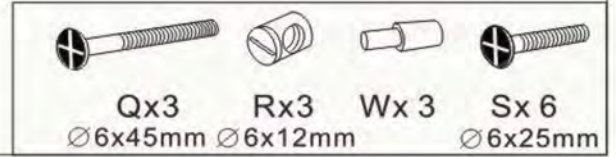
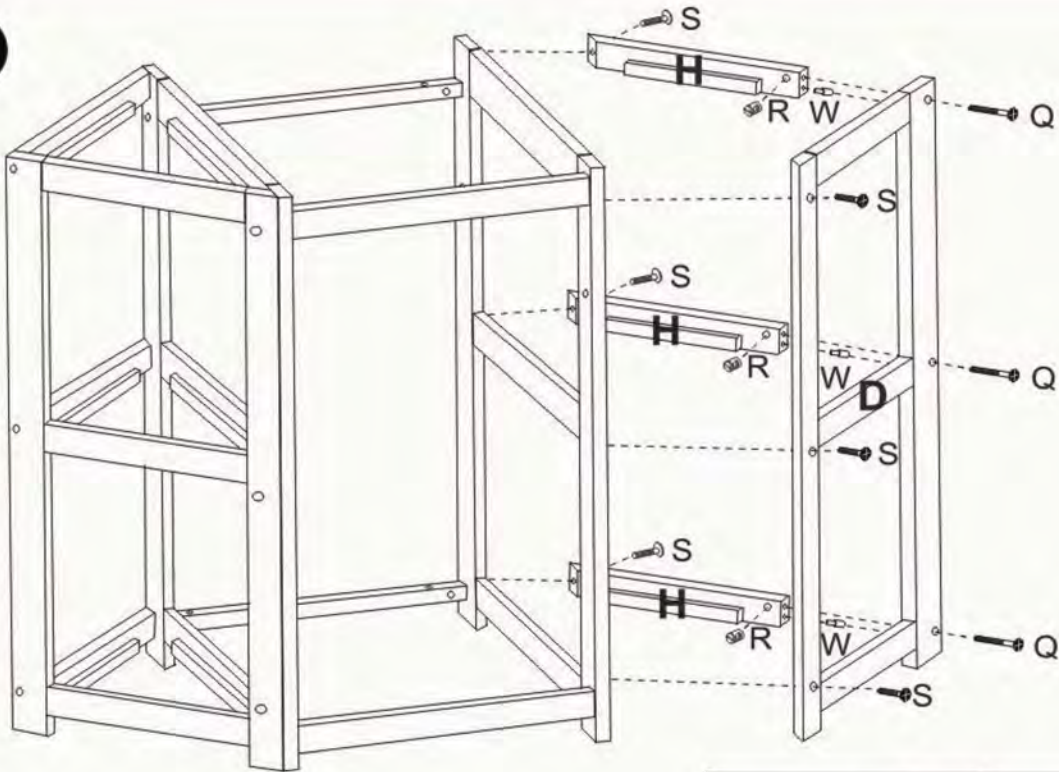



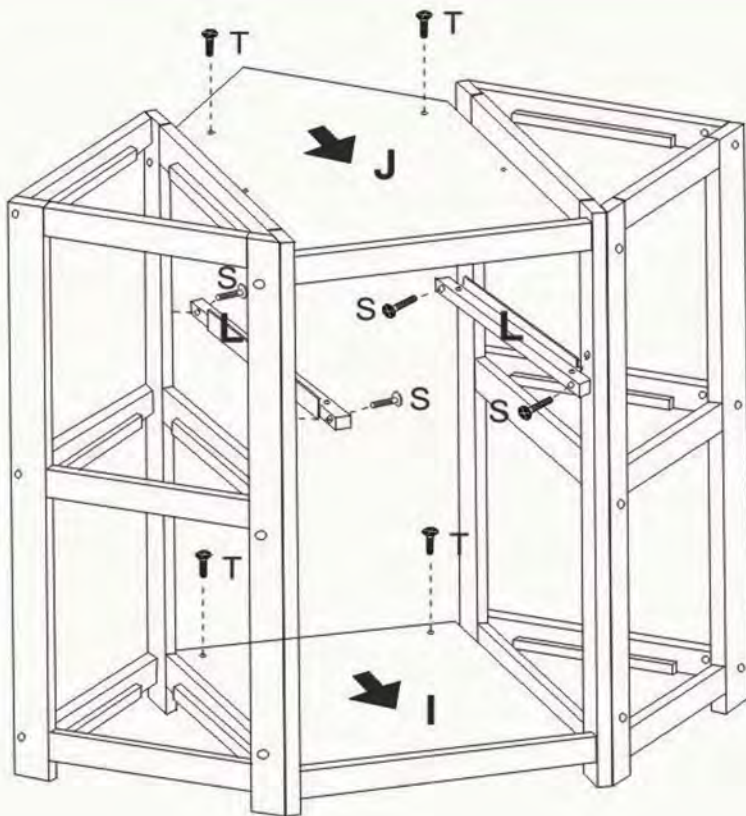

4

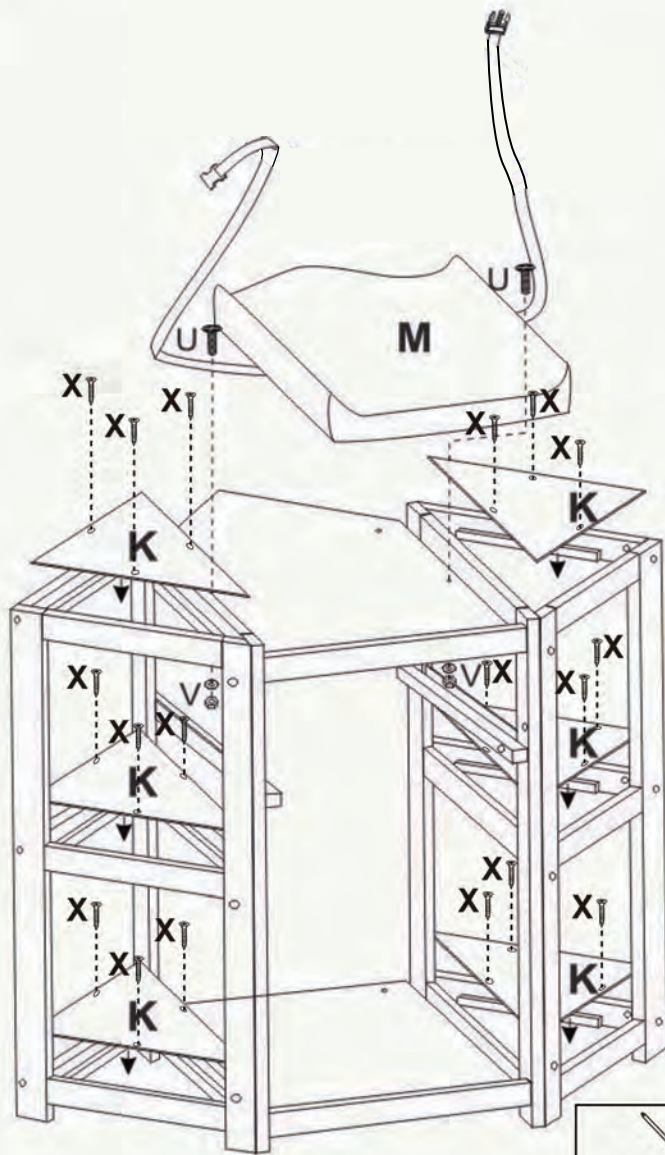

**5**



			
TOOL REQUIRED (NOT INCLUDED)	X×18 Ø4×20mm	U×2 Ø4×20mm	V×2

**6**

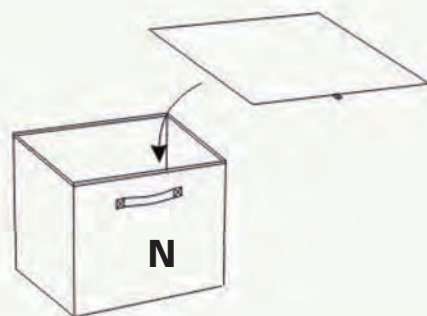
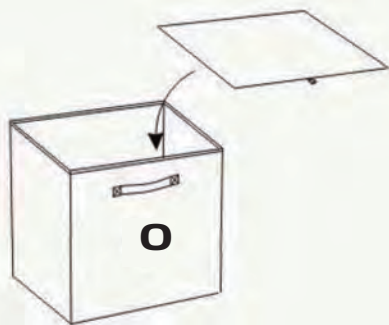

**7**

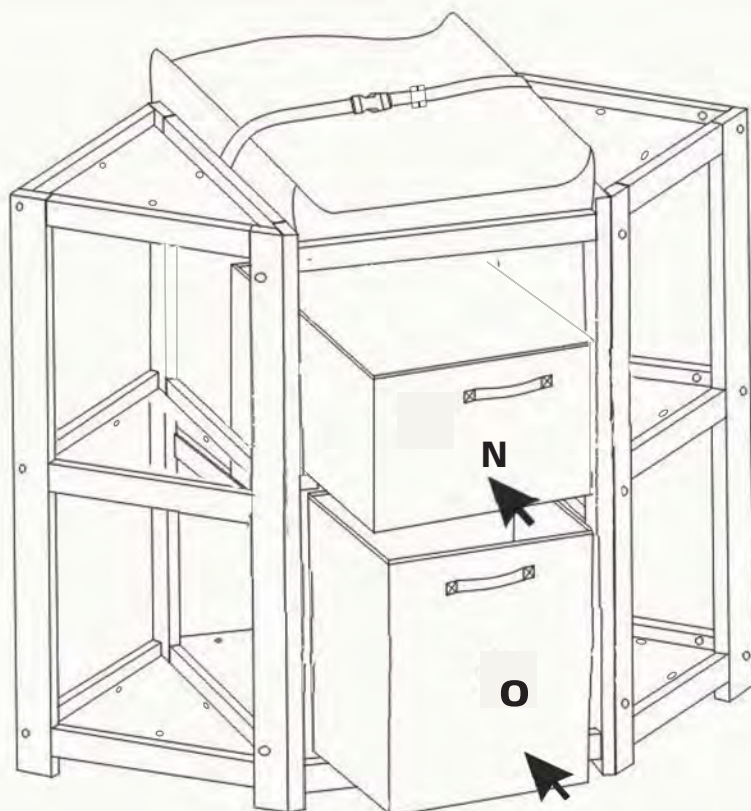

BUCKLE CHILD SECURELY USING THE SAFETY BELT WHENEVER CHILD IS ON THE TABLE. UNCLIP AND SEPARATE THE BUCKLE BY SQUEEZING THE TABS ON THE SIDES TO RELEASE THE BUCKLE TONGUE FROM THE BUCKLE. PLACE CHILD ONTO CHANGING SURFACE AND SNAP THE BUCKLE AND BUCKLE TONGUE BACK TOGETHER. KEEP CHILD'S SKIN/BODY CLEAR OF THE BUCKLE WHEN SNAPPING AND UNSNAPPING TO PREVENT INJURY. BUCKLE IS NOT SECURELY FASTENED UNLESS YOU HEAR AN AUDIBLE "CLICK" TO INDICATE THE PARTS HAVE CONNECTED SECURELY TOGETHER.

NEVER ALLOW CHILD TO STAND UP ON THE TABLE DUE TO RISK OF FALLS AND INJURY OR DEATH.

ALWAYS SECURE THE CHANGING PAD TO THE CHANGING SURFACE BY PLACING IT ONTO THE TOP SHELF AND SECURING IT WITH THE HARDWARE AS SHOWN IN STEP 5.