

Lighted Medicine Cabinet with Mirror

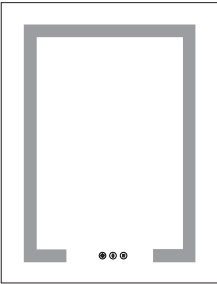

20"×26"

TFGBE100162-1

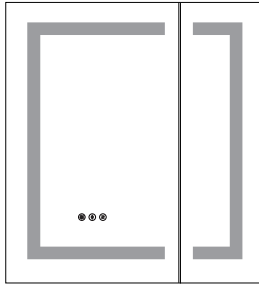

24"×26"

TFGBE100162-2

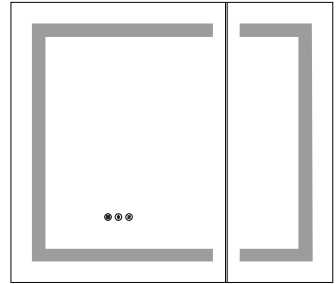

30"×26"

TFGBE100162-3

For easy and safe installation, please refer to the following:

- Read all instructions thoroughly before installing the enclosed product
- Read and take note of all safety, care and maintenance information.

**PLEASE KEEP THIS MANUAL FOR FUTURE REFERENCE
DURING PRODUCT OPERATION AND MAINTENANCE.**

SAFETY INSTRUCTIONS

Thank you very much for choosing our Medicine Mirror Cabinet. For your safety, it is very important that the following instructions are read carefully and completely before beginning the assembly and installation of this lighting fixture:

WARNING -TO REDUCE THE RISK OF BURNS, FIRE, ELECTRICAL SHOCK OR INJURY TO PERSONS:

1. It is strongly recommended that two or more adults install this Medicine Mirror Cabinet.
2. Disconnect power at the circuit breaker before putting on or taking off parts. To disconnect, turn all controls to the off position, then disconnect power from the AC/DC adaptor.
3. Use only power driver that was provided with this product. Using a different power driver will damage the lights and may cause fire, electrical shock hazard.
4. Always wear suitable eye protection before drilling.
5. Keep the voltages between 110V and 120V. If the voltage exceeds 120v, please use the transformer.
6. Use this furnishing only for its intended use as described in these instructions. Do not use attachments/accessories not recommended by the manufacturer.
7. Never operate this furnishing if it is not working properly or if it has been dropped or damaged, or dropped into water.
8. Do not use outdoors. FOR HOUSEHOLD AND INDOOR USE ONLY.
9. Do not operate where aerosol (spray) products are being used or where oxygen is being administered.
10. The appliance is not to be used by persons (including children) with reduced physical, sensory or mental capabilities, or lack of experience and knowledge, unless they have been given supervision or instruction. Children should be supervised to ensure that they do not play with the appliance.

WARNING:

The light source of this product is non-changeable light diodes (LED). Do not disassemble the product, as the light diodes can cause damage to the eye.

CAUTION:

1. Risk of Electrical Shock – Connect this furnishing to a properly grounded outlet only.
2. Grounding Instructions: This product must be connected to a grounded metal, permanent wiring system, or an equipment-grounding conductor must be run with the circuit conductors and connected to the equipment-grounding terminal or lead on the product.

The medicine cabinet supports two installation methods:



1 Surface-mount Installation

2 Recess-mount Installation

Please choose the installation way as needed.

Remove the Door(s) prior to mounting your Cabinet(s)



Cabinet doors were attached to the cabinets to reduce packaging volume. Please remove the doors before mounting the cabinet to the wall and reattach the doors to the cabinet after completing the wall mounting installation.

The installation instructions for the cabinet door are at the end of this user manual.



WARNING: Risk of electrical shock.

A licensed electrician should make all electrical connections.









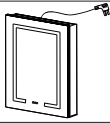

WARNING: Risk of electrical shock.

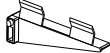
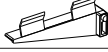
Disconnect power before servicing.

PARTS LIST

What's in the box

No.	Description	Draw	QTY.(pcs)
A	Medicine Cabinet		1
B	Tempered Glass shelf		2
C	Shelf Clips (L)		2
D	Shelf Clips (R)		2
E	Upper Mount Clip		2
F	Bottom Mount Bracket		1
G	Anchor A & M4x45mm Screw		4
H	Anchor B & M4x50mm Screw		4
I	Wire Junction Box		1

TOOLS (not included)



Electric Drill



Pencil



Tape Measure



Phillips-head screwdriver



Spirit Level



Safety Goggles

DIMENSIONS

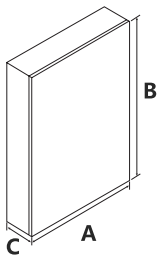

A-Cabinet's Width
B-Cabinet's Height
C-Cabinet's Depth

NOTE: For installation guidance:

- * Surface Mount: Please refer to the overall dimensions of the medicine cabinet.
- * Recess Mount: Consult the rough-in (Wall Cut-out) dimensions for proper fitting.

NOTE: All rough-in dimensions for reference only!

ModelNumber	Item	A	B	C	Rough in size
TFGBE100162-1		20"	26"	5-1/4"	19-1/4"x25-1/4"x4"
TFGBE100162-2		24"	26"	5-1/4"	23-1/4"x25-1/4"x4"
TFGBE100162-3		30"	26"	5-1/4"	29-1/4"x25-1/4"x4"

PRE-ASSEMBLY

PRE-ASSEMBLY ATTENTIONS:

1. After opening the package, please inspect the product immediately for any damage during transit or missing parts.
2. Remove all parts and hardware from the box along with any plastic protective packaging.
3. Do not discard any contents until after assembly is complete to avoid accidentally discarding small parts or hardware.
4. Before drilling, please ensure there are no hidden cables or pipes (water, gas, or electrical) behind hanging points.
5. If the product is placed on the ground for operation, please place a blanket to protect under the product. Do not place the product on the ground directly.

★ Verify minimum clearances

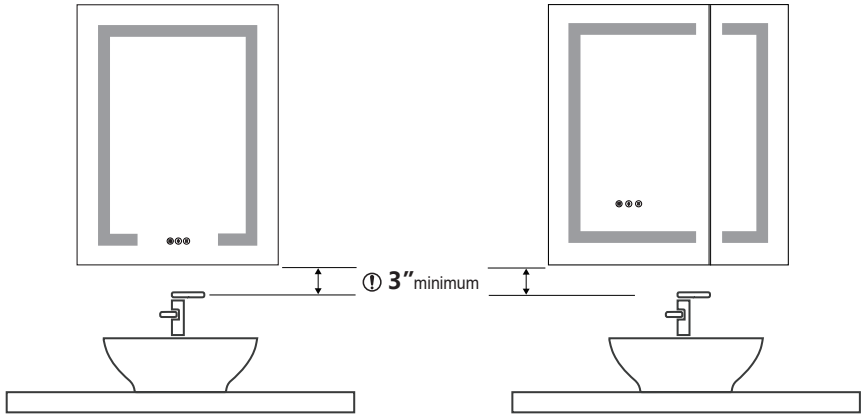

★ Place the mirror cabinet in the installation area, ensuring there is a gap of more than 1" between the cabinet and the wall.

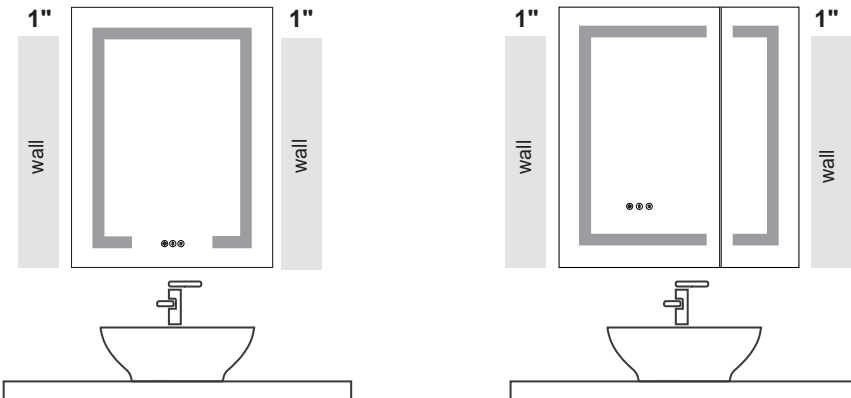

ELECTRIC CONNECTIONS

ALL WIRING SHOULD BE DONE BY A QUALIFIED LICENCED ELECTRICIAN.

! WARNING: Shut off power before wiring the cabinet.
Requires 120 VAC 20 Amp GFI protected circuit.

GROUNDING INSTRUCTIONS:

! CAUTION: This product must be connected to a grounded metal permanent wiring system or an equipment-grounding conductor must be run with the circuit conductors and connected to the equipment grounding terminal or lead on the product.

! WARNING: An electrical option cabinet must be wired to a 20 Amp GFI (Ground Fault Interrupter) protected circuit when used in bathrooms and all other locations required by the National Electric Code.

Safety First! Wire Connection Guide

There are two ways to connect the power. You can connect the wires directly to your junction box or insert the plug directly into the wall socket.

Option 1: Plug-in

Insert the plug to the socket

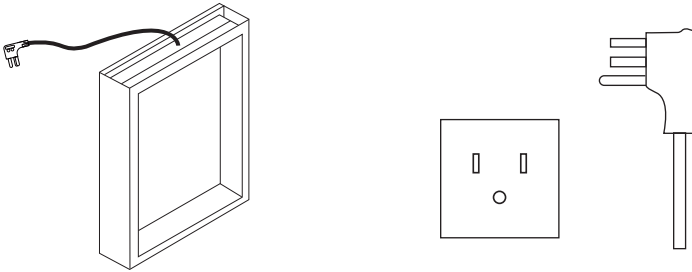

Option 2: Hardwired

Remove the plug and use the included junction box to connect the wires with the household wiring.

BLACK WIRE --- POWER SUPPLY L (LINE)
WHITE WIRE --- POWER SUPPLY N (NEUTRAL)
GREEN WIRE --- POWER SUPPLY G (GROUND)

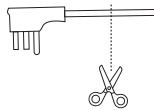

How to Connect?



1. Strip the wire insulation approximately 10mm.



2. Open the connector and insert the wire into the outlet.



3. Press the connector to complete the wiring.

PRIOR TO MOUNTING

★ Remove the Door(s) prior to mounting your Cabinet(s). ★

1

! For recess mount only!

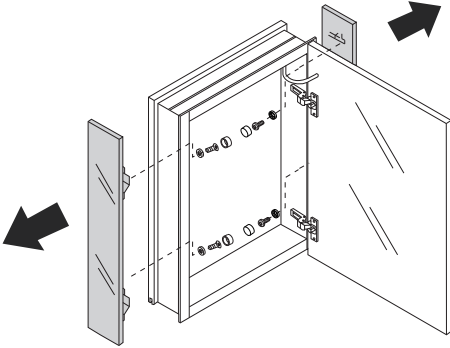

- Carefully remove side mirror panels for recess mount installation.

2

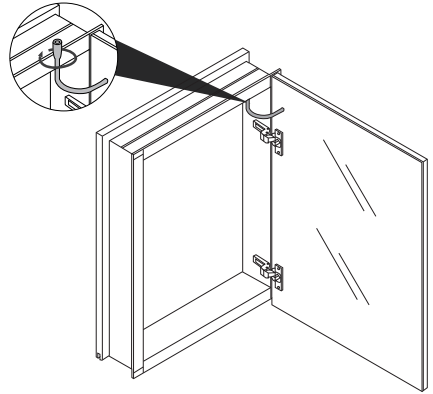

- Remove door(s) prior to mounting your cabinet. Start with unplugging the door from the cabinet.

3

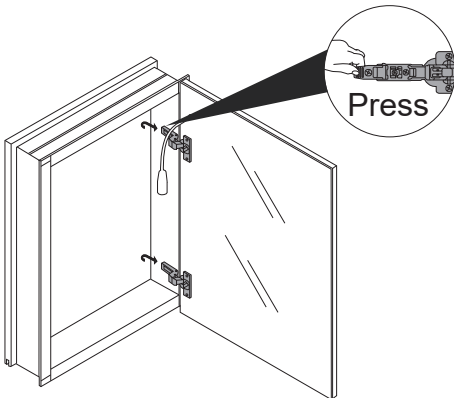

- While supporting the door release (the lever under the hinge arm), slide the door off the frame.

4

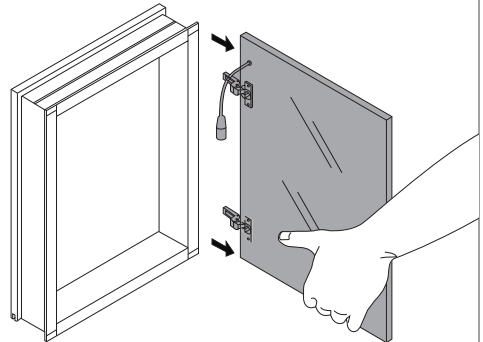



- Take off the door(s) carefully and lay it down on a safe area.

SURFACE MOUNT INSTALLATION

Secure it! Wall Anchoring Guide

The hardware used to secure your medicine cabinet to the wall depends on your wall material. If your wall material is not listed or if you have any questions, consult with a local hardware retailer.

Thickness of Wall	Applicable Anchors&Screws	Recommended Drill Bit	Recommended Drill Depth
>5/8"(16mm)		5/16"(8mm)	50mm
5/16"-5/8"(8-16mm)		25/64"(10mm)	
<5/8"(8mm)		Unapplicable	Unapplicable

1

Place the medicine cabinet against the wall and mark the placement of the cabinet. Draw a line on the wall with a level and marker to indicate where the cabinet bottom is.

Attention: Please hang the cabinet at least 3 inches above the faucet.

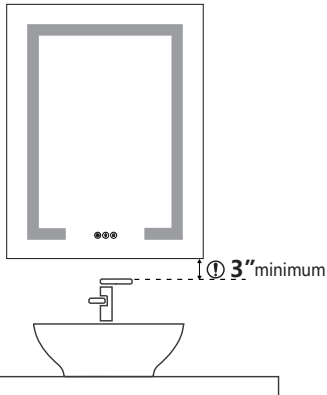

2

 Bottom mounting brackets must be attached to furring strip/channel or wall studs

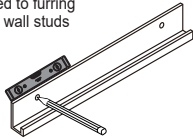

Mark spots for the bottom bracket.

3

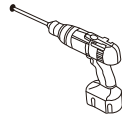

Drill holes in the wall.

4

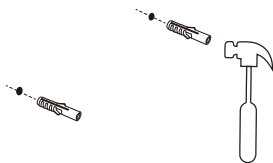

Plug the plastic anchors into the holes.

5

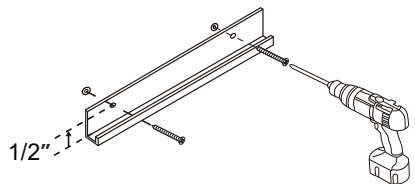

Fasten the mounting bracket to the wall.

SURFACE MOUNT INSTALLATION

6

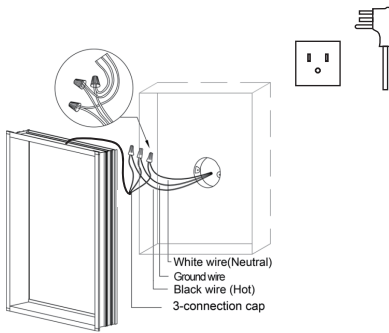

Hardwired or Plug-in.

7

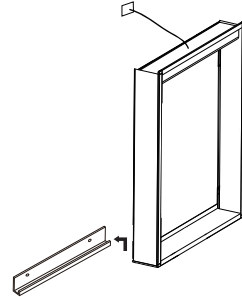

Lift the cabinet onto the mounting bar. Ensure the hooks engage the bar.

8

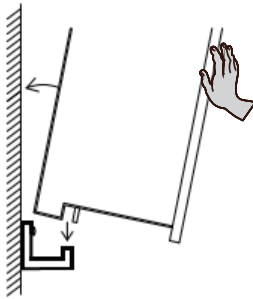

Place the medicine cabinet securely onto the lower bracket and hold it upright

9

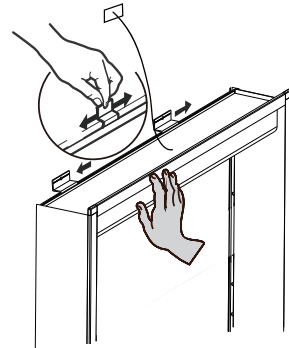

NOTE: Secure two upper brackets in the groove on top of the cabinet and mark the spots on the wall.

10

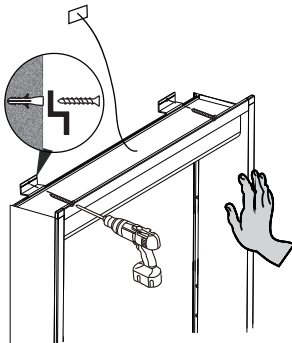

! Top mounting brackets must be attached to furring strip/channel or wall studs.

Use an electric drill to punch holes at the marked spots, secure the upper brackets in the groove, and mount them to the wall with screws.

11

! Make sure cabinet is leveled and fully inserted into the groove of the bottom bracket.

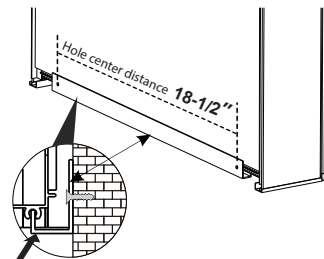

Test the fit of the cabinet before final assembly.

RECESS MOUNT INSTALLATION CONTINUED

1

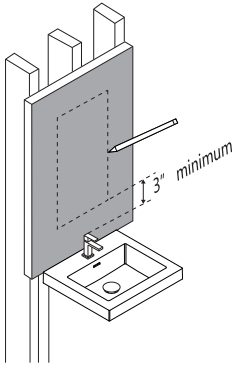

Make an outline for the cabinet.

2

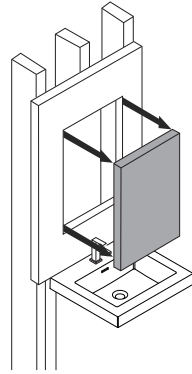

Cut the marked perimeter with suitable tool.

3

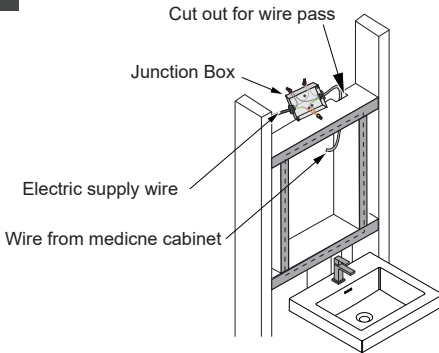

Frame the opening for the cabinet based on the measurements.

4

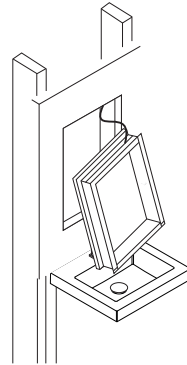

Connect electrical wires before inserting the cabinet into the opening.

5

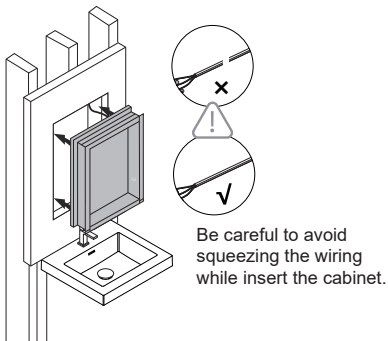

Position cabinet in cut out opening.

6

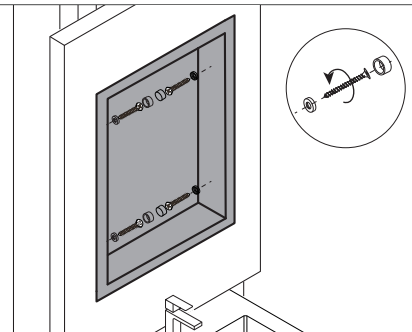

Secure the cabinet to the framing studs with screws.

FINAL ASSEMBLY

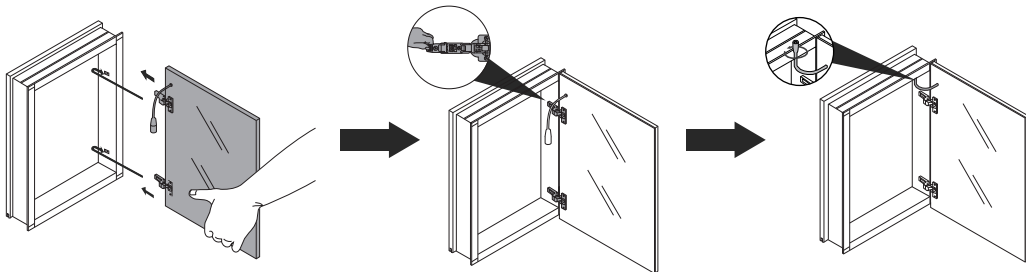

1. Slide the doors into place by pinching the end of the hinges.
2. Plug the door into the cabinet.

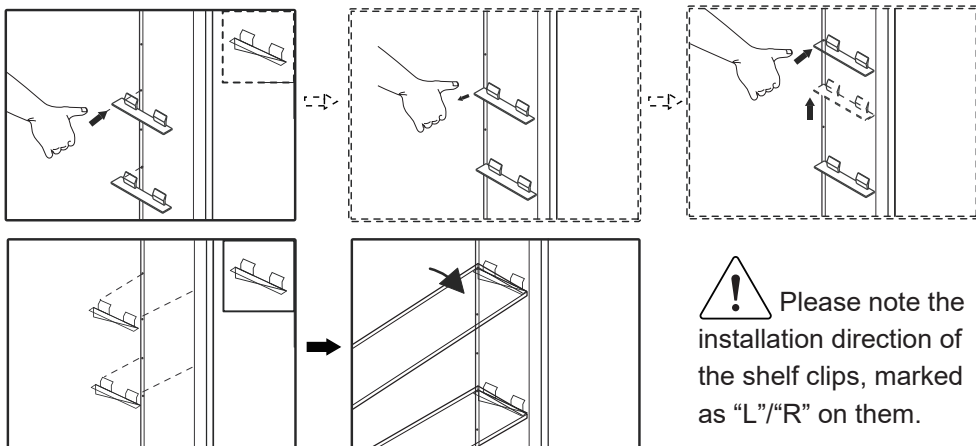

! Please note the installation direction of the shelf clips, marked as "L"/"R" on them.

Insert clear snap-in shelf clips into holes on the sides of the cabinet.

HINGE ADJUSTMENT

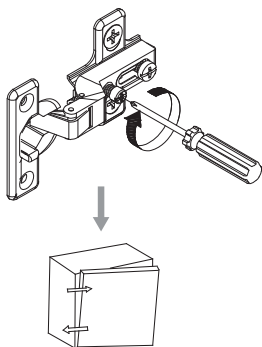

Turn the screw to adjust the depth of door overlay;

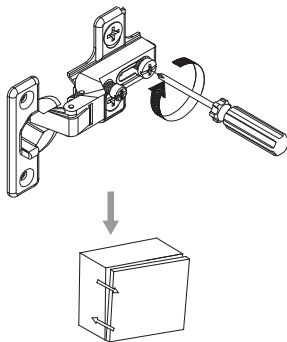

Turn the front screw to adjust the gap between the door and cabinet;

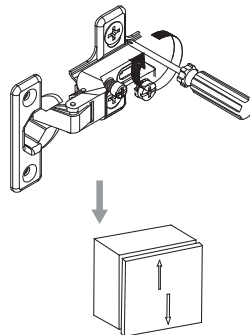

Turn the eccentric screw to release the door, allowing the door to be moved up and down.

BUTTON CONTROL

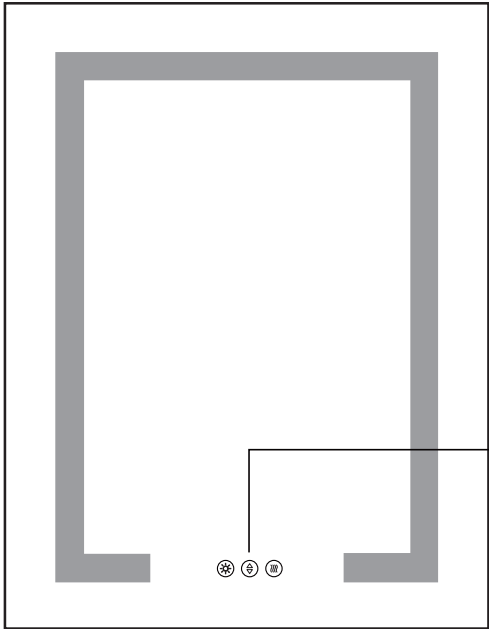

TURN ON/OFF & COLOR



STEPLESS DIMMING



DEFOGGER



* Tap once to switch on the light, and tap three times to turn it off.

* To change the color temperature, simply tap the button to select your preferred setting: warm light, natural light, or cool white light.



Press and hold to adjust the light's brightness. (Factory Setting: The mirror comes pre-set at 100% brightness. If you find it too bright, simply press and hold to dim the light to your desired level.)



Tap the button to activate or deactivate the defogging feature. When the defogger is operational, the button will illuminate in white. The defogger is designed to switch off automatically after 60 minutes. To reactivate, simply tap the button again.

SPECIFICATIONS

PARAMETER	SPECIFICATION
Dimmer	10%-100%
Color Temperature	3000K/4000K/6500K
LED Light Quantities	192pcs/M
LED Life Span	50,000 hours
CRI	90+
Defogger	YES
Memory Function	YES
Switch	Touch Sensor
Input Voltage	120V AC
Output Voltage	24V DC
Certification	ETL Certified for damp location
Copper Free Mirror	YES
Wiring Method	Hardwired or Plug-in
Dual Ports	2 Outlets + 2 USB
Mount Type	Recessed / Surface

MAINTENANCE

Use Environmental Requirements

- Mirror cabinet is suitable for use in damp environments and should not be installed directly within splash zone.
- Do not allow water to splash on the cabinet body. If you accidentally get water, wipe it with a dry cloth in time to keep the cabinet dry and clean.

Cleaning and Maintenance

- For safety, please always unplug this medicine mirror cabinet before cleaning.
- The interior is constructed of mirrored glass and aluminum. Use only a damp cloth to clean. Ammonia or vinegar based cleansers can damage mirrors.
- When cleaning, spray the cloth, not the mirror, or surrounding surfaces. Do not use abrasive cleansers on any parts of the light fixture.