

ASSEMBLY INSTRUCTIONS



OFFICE CHAIR

ASSEMBLY INSTRUCTIONS

ASSEMBLY TIPS:

- 1.Remove hardware from box and sort by size.
- 2.Please check to see that all hardware and parts are present prior to start of assembly.
- 3.Please follow attached instructions in the same sequence as numbered to assure fast & easy assembly.



WARNING !







- 1.Don't attempt to repair or modify parts that are broken or defective. Please contact the store immediately.
- 2.This product is for home use only and not intended for commercial establishments.







ASSEMBLY TIME

20 MINUTES

PARTS IDENTIFICATION

A		BACK	1PC
B		ARM	1SETS
C		BASE	1PC
D		COVER	1PC
E		GAS LIFT	1PC
F		MECHANISM	1PC
G		CASTER	5PCS

HARDWARE IDENTIFICATION

1	WASHER	 M6*18MM*1.2	4PCS
2	SHORT SCREW	 M6*20MM	4PCS
3	LONG SCREW	 M8*50MM	4PCS
4	ALLEN KEY	 M6	1PC
5	ALLEN KEY	 M8	1PC

ASSEMBLY INSTRUCTIONS

STEP1

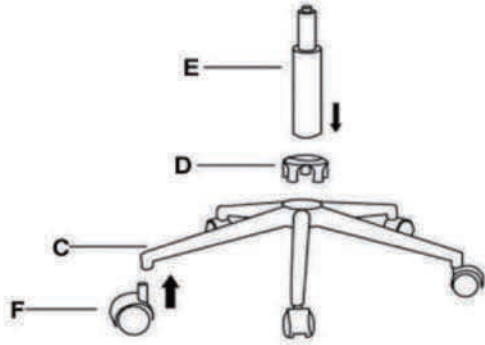

STEP2

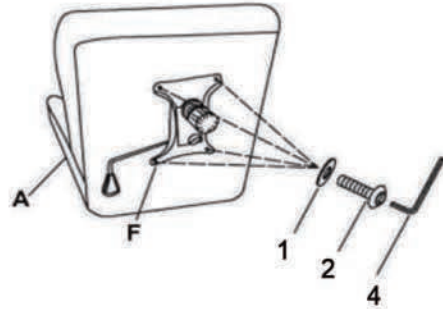

STEP3



STEP4

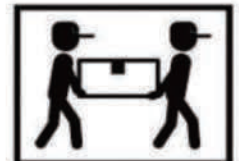



Note : Dimension tolerance $\pm 5\%$

