

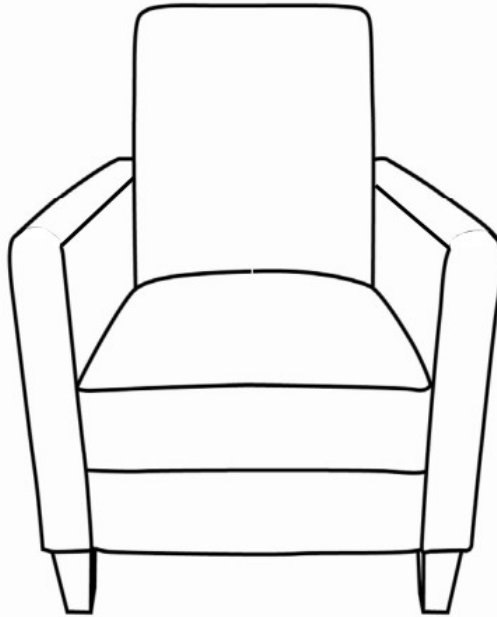





Assembly Instructions

Caution : You must read this before you proceed



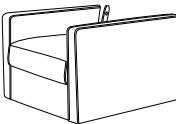

Club Chair



Parts List

Label	Picture	Description	QTY
A		Chair Backrest	1
B		Chair Base Body	1
C		Front Leg	2
D		Back Leg(Left)labeled "D"	1
D		Back Leg(Right)labeled "D1"	1

Hardware



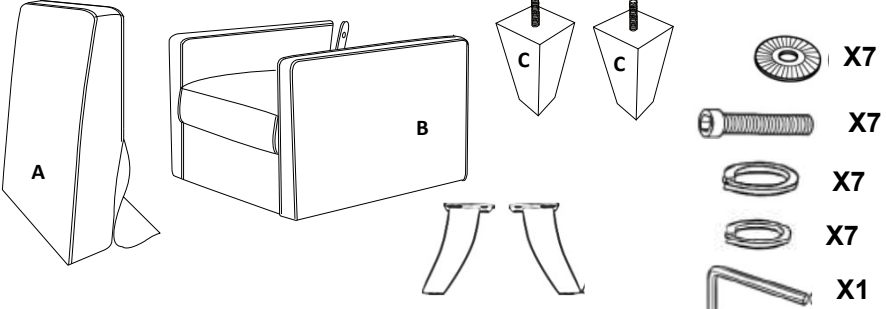

Label	Picture	Description	QTY
①		Washer Rings	3
②		Bolt(M8*30mm)	7
③		Spring Washer Ring	7
④		Flat Washer Ring	7
⑤		Allen Key	1

Assembly Preparation

Before Beginning Assembly:



- X7
- X7
- X7
- X7
- X1

-  • Read instructions, cover to cover-
-  • Have 2 adults on hand for assembly-
-  • Do not assemble on flooring or carpet-
-  • Assemble on a clean non-marring surface (packing foam)-
-  • Save all packaging until finished-

Assembly Steps

OVERVIEW

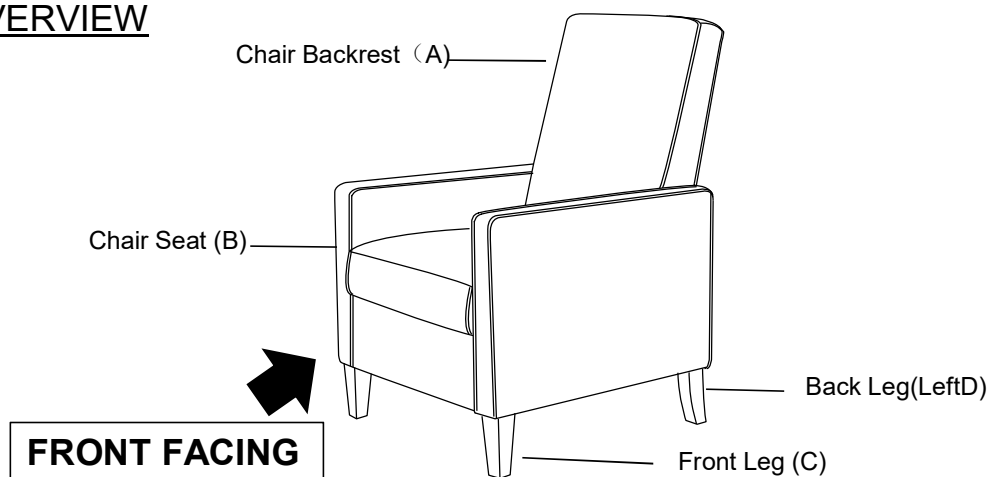

This Club Chair has multiple parts and may require up to 30 minutes to assemble. To give you an overview of the Club Chair parts, the above picture is to help you put the various Club Chair parts into perspective. Please read through the instructions to familiarise yourself with the parts and steps before assembly.

Step 1

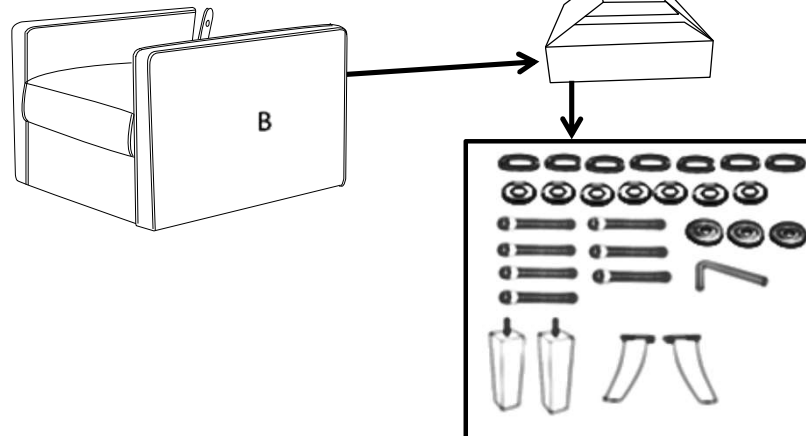

Position the Chair on its back as shown. (Perferrably on a surface that won't scratch the upholstery.) Open the inner box and take out the 4 wooden legs provided.

Step 2

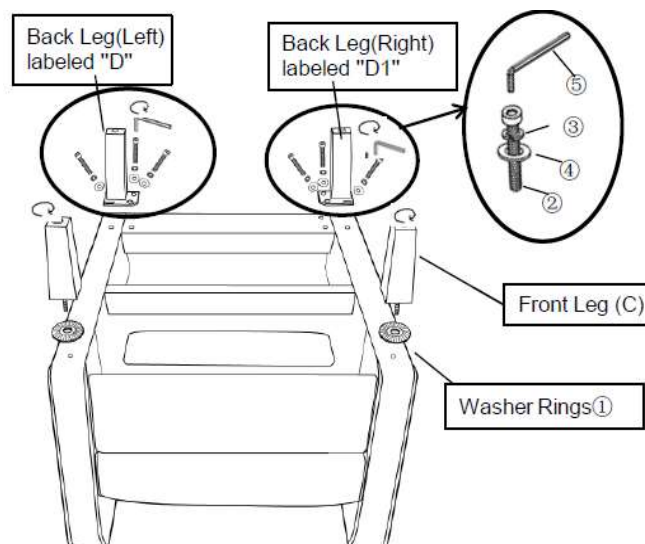

Install the Front Leg(C) and Back Leg(Left&Right) into the bottom of the Chair Base Body(B) by placing a Washer Ring (①) Bolt(②) Spring Washer Ring(③) Flat Washer Ring(④) with Allen Key(⑤) onto the threaded stem. And then insert the threaded Stem into the threaded Mounting Position at each Corner of the Bottom of the Chair.

Note: The use of Washer Rings are OPTIONAL and is especially useful to help alleviate slight wobbleness. Some legs may need more than one Washer Ring whilst some legs may not need any.

Step 3

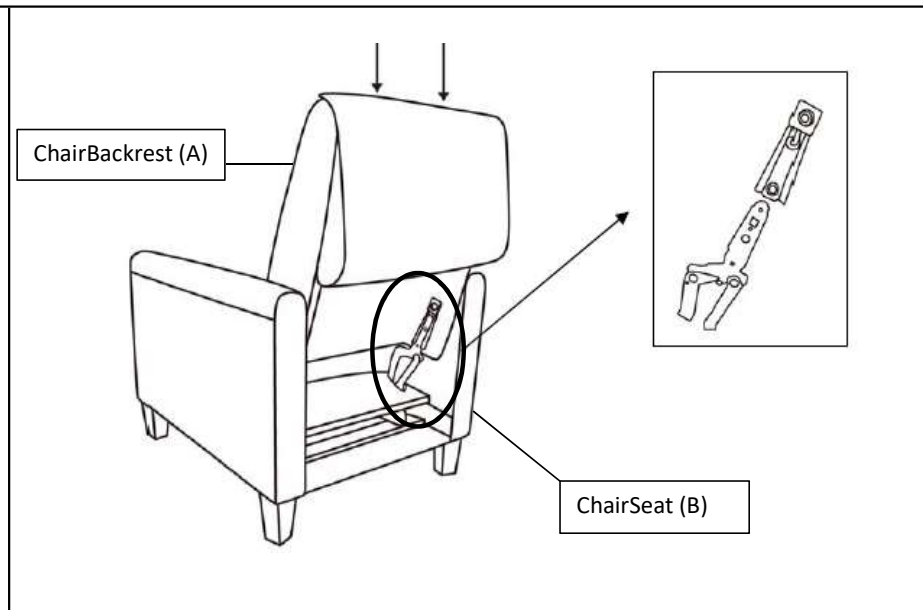

With assistance from your adult partner, hold up the fully assembled Chair Backrest (A) with Wings, stand behind the Chair. Insert the small Metal Arms on the sides of the Chair Backrest(A) into the prefabricated slide lock gadget on the Chair Base Body(B) as shown above.

Firmly but gently, push the Chair Backrest (A) downwards until the Backrest(A) is fully slotted and locked into position.

Step 4

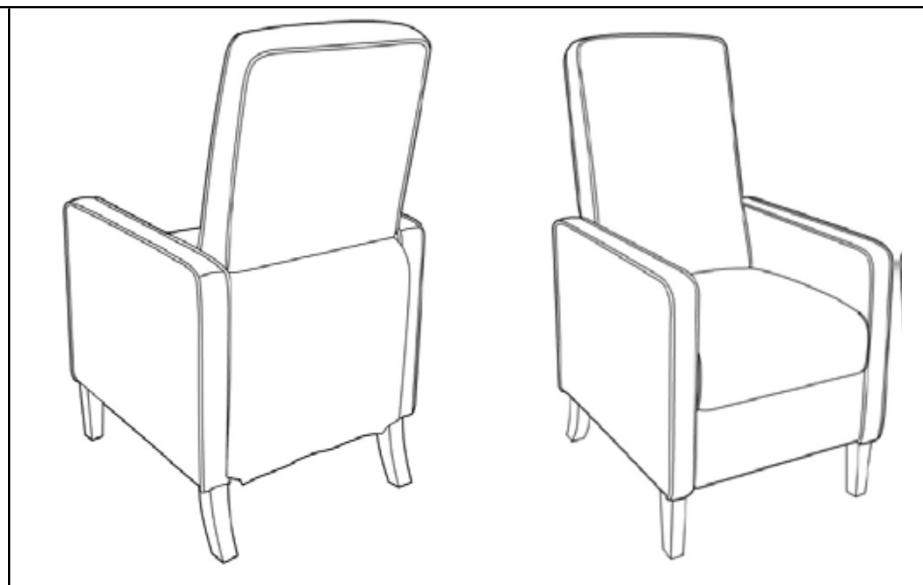

Smooth down the fabric flap on the Chair Backrest (A). Run your hands down both sides of the flap, from top to bottom, allowing the velcro tape to adhere to the flap under the back of the chair.

Your Club Chair is ready for use.

Your Club Chair can only be used on a flat, level surface.

User Instructions.

Recliner Chair

Please read the Instruction Manual below carefully before use.

This is a Recliner Chair. At anytime in a reclined seat position or in the upright position. You may enjoy the rocking motion by using your body weight in a back-front rocking motion.

Supervise children, when in use of this Recliner.

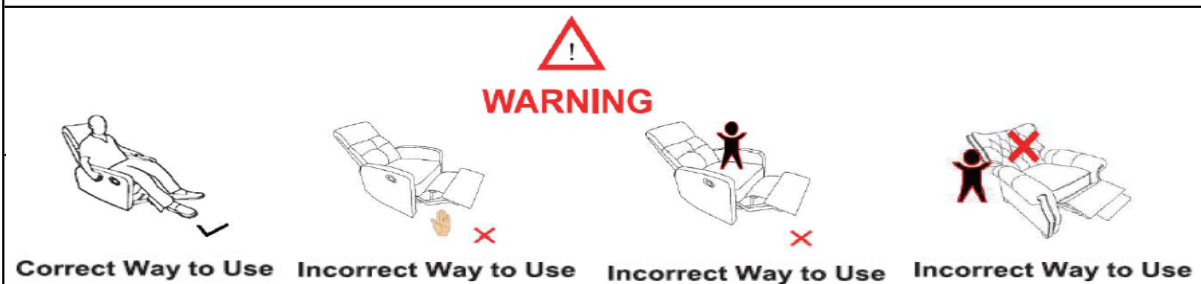

Do not allow children to play on the chair.
Always leave the chair in an upright and closed position after use.
Keep hands and feet clear of the footrest mechanism and ANY gaps.
Only the occupant should operate the Chair.

To get into a reclined posture - To Recline backrest

Sit into the seat.
Place your feet apart .
Place your left and right arm onto the armrest.
Synchronise a backward push with your arms.
Use your body weight and push backwards into the seat into a fully reclined position.

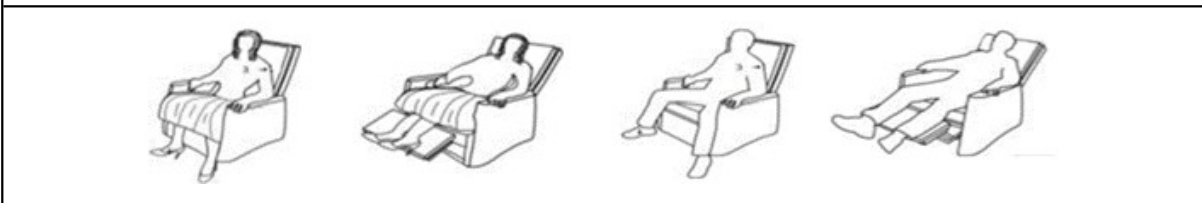





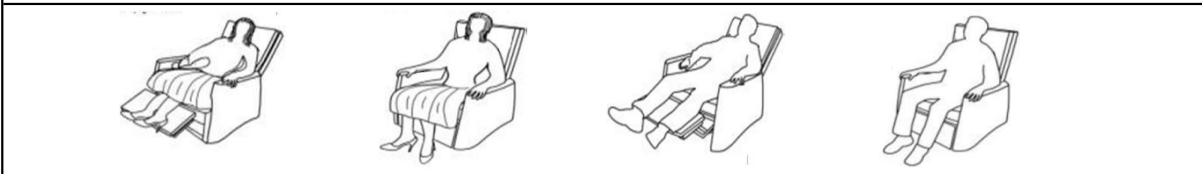



To get out of chair - move Seatback into Upright Position

Tilt your body weight slightly forward and upwards.
The seat back will come up to an upright position.
Where necessary, use either your arms help lift- push yourself out of the seat.

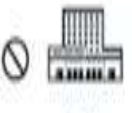

Care & Maintenance

-  Do not put hot items directly on furniture surface
-  Do not clean furniture with harsh cleansers or polish.
-  Do not place furniture under direct sunlight.
-  Do not place furniture near heating or cooling vents.
-  Do not write on furniture without a padded barrier to protect the surface.
-  Do not place furniture outside. For indoor use only.
-  Not for commercial use. For residential use only.
-  Stains may be removed with mild soap solution and damp cloth.
-  Children should not climb or jump on the furniture.

-
-  Dust and pick-up spills using a clean, non-colored, lint-free cloth.